

USR-G809 User Manual

Document version: V1.0.1



USR-G809 User Manual.....	1
1. Introduction.....	4
1.1. Overview.....	4
1.2. Features.....	4
1.3. Specification.....	5
1.4. Interface.....	6
1.5. Indicator.....	7
1.6. Dimensions.....	8
2. General Function.....	9
2.1. Web Interface.....	10
2.2. Hostname.....	11
2.3. User Password Settings.....	11
2.4. Reboot Timer.....	12
2.5. Backup/Upgrade.....	13
2.6. Reboot.....	14
2.7. Reload Button.....	14
3. Interface.....	15
3.1. WAN Interface.....	16
3.2. LAN Interface.....	17
3.3. Cellular Network Interface.....	18
3.4. WLAN Interface.....	20
3.5. VLAN.....	23
3.6. DIDO.....	24
3.7. User-defined Indicator.....	27
4. Network.....	28
4.1. Network Switch.....	28
4.2. DHCP.....	29
4.3. Hostnames.....	29
4.4. Static Routes.....	30
4.5. Diagnostics.....	32
5. VPN.....	33
5.1. PPTP Client.....	33
5.2. L2TP Client.....	35
5.3. IPSec.....	36
5.4. OpenVPN.....	37
5.5. GRE.....	39
6. Firewall.....	40
6.1. General Settings.....	40
6.2. NAT.....	40
6.3. Traffic Rules.....	43
6.4. Access Restriction.....	50
7. Serial Port.....	52
7.1. Connecting Hardware.....	52

7.2. Serial Port Settings.....	53
7.3. Operation Mode.....	54
7.4. General Function.....	59
8. USR Cloud.....	65
8.1. Cloud Monitor.....	65
8.2. Add device.....	66
8.3. Network Status.....	66
8.4. Parameter Configuration.....	67
8.5. Firmware Upgrade.....	68
8.6. Records of device.....	69
8.7. Alarm.....	71
8.8. Remote Configuration.....	73
9. Services.....	76
9.1. Syslog.....	76
9.2. NTP.....	77
9.3. Email.....	78
9.4. SMS.....	80
9.5. Alert.....	80
9.6. Alert Examples.....	82
9.7. Call Reboot.....	92
9.8. Geolocation.....	92
9.9. DDNS.....	94
10. AT Commands Settings.....	97
10.1. AT Command Mode.....	97
10.2. Serial AT Commands.....	98
10.3. Network AT Commands.....	99
10.4. SMS AT Commands.....	100

1. Introduction

1.1. Overview

USR-G809 is a new generation of 4G LTE industrial router with rich interfaces and comprehensive functions. It supports WIFI access point, serial to network, VLAN, DIDO, Email/SMS alert, USR Cloud service function. G809 device adopts industrial design, with multiple hardware protection, built-in watchdog.

It has been widely used in the M2M industry in the Internet of Things, providing stable and reliable LTE network for smart factories, photovoltaic industry, wind power generation, airport transportation, smart medical care and other fields.

1.2. Features

Stable and Reliable

- Industrial design, metal housing, protection class IP30.
- Wide voltage DC 9-36V input, with reverse polarity protection
- 9-36V wide power supply range, anti-reverse protection.
- ESD, surge and EFT protection.
- Hardware watchdog, link detection mechanism make it self-recovery from unexpected failure and guarantee system stability.

Flexible Networking

- Provide 4G network, compatible with 3G/2G network.
- Supports automatic network inspection, 4G/3G/2G network switching, APN/VPDN card.
- Supports wired /4G multi-network online at the same time, multi-network backup function.
- Supports 2.4GHz, 5GHz (Optional)WIFI.
- Supports VPN (PPTP, L2TP, IPSEC, OpenVPN, GRE) and VPN encryption.

Powerful Functions

- Supports multiple WAN connections, including static IP, DHCP, PPPoE, 2G/3G/4G.
- Supports DDNS, static route, firewall, NAT and access restriction.
- Supports RS232/RS485 serial port and multiple socket connections.
- Supports VLAN function, different LAN port can be assigned different network segment.
- Supports downloading/uploading the configuration files to achieve batch parameter settings.
- Supports monitoring and upgrading via PUSR Cloud to achieve the remote maintenance.
- Supports NTP function and restore via the "Reload" button.
- Provides link detection mechanism, anti-drop mechanism to ensure that data terminals are always online.
- Supports email, SMS and DO alert function, to get the device status via the alarm information.
- Supports DIDO function, simple hardware connection and flexible configuration.
- Supports upgrading via USB port and custom indicator light.
- Supports call reboot to achieve restart the device via the mobile phone.
- Supports remote configuration via USR Cloud.
- GPS positioning supported(Optional)

1.3. Specification

	Region	EMEA/Korea/Thailand/India	Europe/Australia
	Frequency bands	LTE-FDD: B1/B3/B7/B8/B20 LTE-TDD: B38/B40/B41 WCDMA: B1/B5/B8 GSM/EDGE: B3/B8	LTE-FDD: B1/3/5/7/8/20/28 LTE-TDD: B38/40/41 WCDMA: B1/5/8 GSM/GPRS/EDGE: 850/900/1800M Hz
Cellular Network	Theoretical bandwidth	LTE-FDD: Max. 150Mbps (DL)/50Mbps (UL) LTE-TDD: Max. 130Mbps (DL)/30Mbps (UL) DC-HSPA+: Max. 42Mbps (DL)/5.76Mbps (UL) WCDMA: Max. 384Kbps (DL)/Max. 384Kbps (UL) EDGE: Max. 296Kbps (DL)/Max. 236.8Kbps (UL) GPRS: Max. 107Kbps (DL)/Max. 85.6Kbps (UL)	LTE-FDD: Max. 150Mbps (DL)/50Mbps (UL) LTE-TDD: Max. 130Mbps (DL)/30.5Mbps (UL) DC-HSPA+: Max. 42Mbps (DL)/5.76Mbps (UL) WCDMA: Max. 384Kbps (DL)/Max. 384Kbps (UL) EDGE: Max. 296Kbps (DL)/Max. 236.8Kbps (UL) GPRS: Max. 107Kbps (DL)/Max. 85.6Kbps (UL)
Wireless Parameters	Standards	IEEE802.11b/g/n, 2.4GHz, AP mode	
	Theoretical bandwidth	IEEE802.11b/g, max. 54Mbps; IEEE802.11n, max. 150Mbps	
	Security	OPEN、WPA-PSK、WPA2-PSK TKIP、AES	
	Distance	100m in open area	
Serial Modem	Mode	NET, HTTPD, MODBUS	
	Heartbeat/Registry packet	Support	
	Baud rate	1200/2400/4800/9600/19200/38400/57600/115200/230400	
	Data bits	8	
	Stop bits	1, 2	
	Parity	NONE, ODD, EVEN	
	Serial type	RS232 or RS485	
SOCKET	Socket A~D, support TCPS(Only socket A)/TCPC/UDPS/UDPC		

Power	Power supply	DC 12V/1A
	Voltage range	DC 9 ~ 36V
	Operation current	Avg. 522mA, max. 811mA/12V
Physical characteristics	Housing	Metal, IP30 protection class
	Dimensions	125.0*103.0*45.0mm (L*W*H, excluding mounting parts and antenna base)
	EMC	Level 3
Environmental performance	Operating temperature	-20°C ~ +70°C
	Storage temperature	-40°C ~ +125°C
	Operating humidity	5% ~ 95%RH(non-condensing)
	Storage humidity	1% ~ 95%RH(non-condensing)

Power consumption:

USR-G809 works at full speed, with 1 WIFI station access, 1 LAN port access, and 4G access to the external network.

Operating mode	Power supply	Average current (mA)	Maximum current (mA)	Minimum current (mA)
LAN+WAN, full speed (4G +WLAN)	DC12V	522	811	392
LAN, full speed (4G+WLAN)	DC12V	510	801	380
LAN+WAN, full speed (WLAN)	DC12V	412	659	275
WAN, full speed (WLAN)	DC12V	366	565	246

When G809 is powered by 12V and working at full speed: The average power consumption is 6.3W and the maximum is 9.7W. The average current is 522mA and the maximum is 811mA.

Note: It is recommended to use the power adapter provided by our company.

1.4. Interface

No.	Item	Description
1	DC interface	DC:9~36V, standard 5.5*2.1mm round socket
2	WAN	1*10/100M, MDI/MDIX, 1.5KV electromagnetic isolation protection
3	LAN	4*10/100M, MDI/MDIX, 1.5KV electromagnetic isolation protection

4	USB interface	Firmware upgrading
5	Indicator lights	PWR、WORK、WLAN、USR、NET、SIG*3
6	SIM slot	3V/1.8V SIM card, ESD 15KV
7	Reload button	Restore to factory settings/restore the firmware/upgrade via USB port
8	WIFI antenna interface	2* standard SMA male antenna connector
9	4G antenna interface	2* standard SMA female antenna connector 4G-M is the main antenna, 4G-D is the auxiliary one.
10	Ground screw	Router grounding helps prevent the noise effect due to electromagnetic interference (EMI). Connect the router to the site ground wire by the ground screw before powering on.
11	TF card slot	Reserved interface.
12	Terminal interface	V+, V- : power interface, built-in anti-reverse protection GNG: Ground terminal Tx/B: RS232 or RS485, can be set via webpage Rx/A: RS232 or RS485, can be set via webpage DI1、DI2、DO1、DO2: DIDO terminal interface COM: DO loop terminal.
13	TBD	Debug interface.

1.5. Indicator

Item	Description
PWR	Power indicator, always on red after powered on.
WORK	Work indicator, 1 sec blink after booting.
WLAN	WiFi indicator, always on green when Wi-Fi is enabled and working properly.
USR	User-defined indicator, can be set via the webpage(socket, VPN...)
NET	Always on after connecting to the network. Two colors indicate 4G network, green indicates 3G and red indicates 2G.
SIG(1-3)	Signal strength indicator, the more lights on, the stronger the signal.

1.6. Dimensions

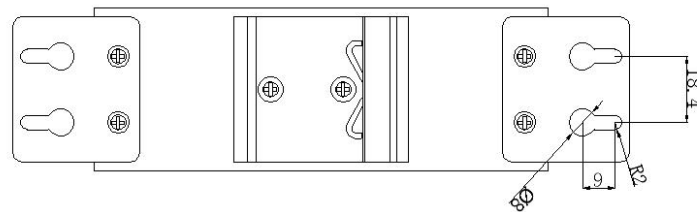
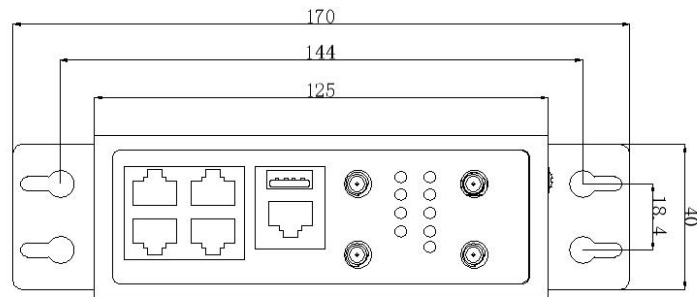
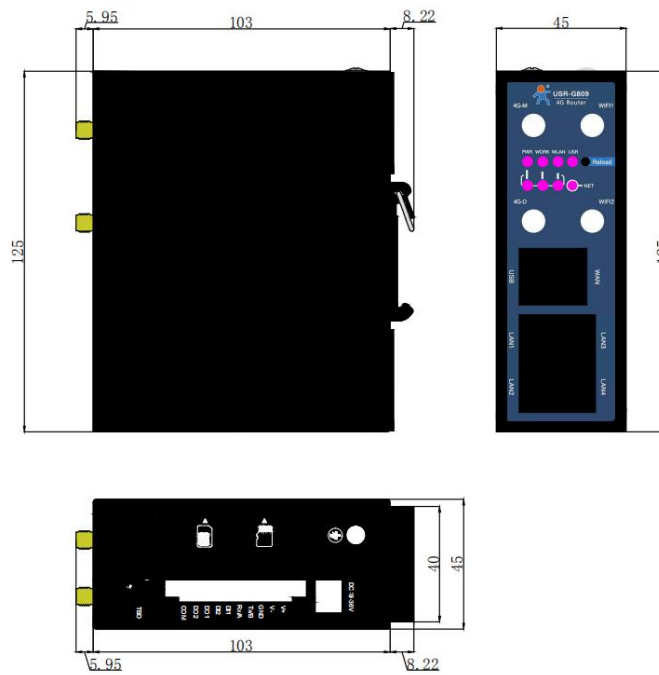

Note:

- Metal housing, support panel mounting and DIN-rail mounting.
- Dimensions of DIN-rail mounting: 125.0*117.2*45.0mm(L*W*H, including DIN-rail parts and antenna base).
- Dimensions of panel mounting: 170.0*117.2*45.0mm(L*W*H, including DIN-rail parts, panel mounting kits and antenna base).

2. General Function

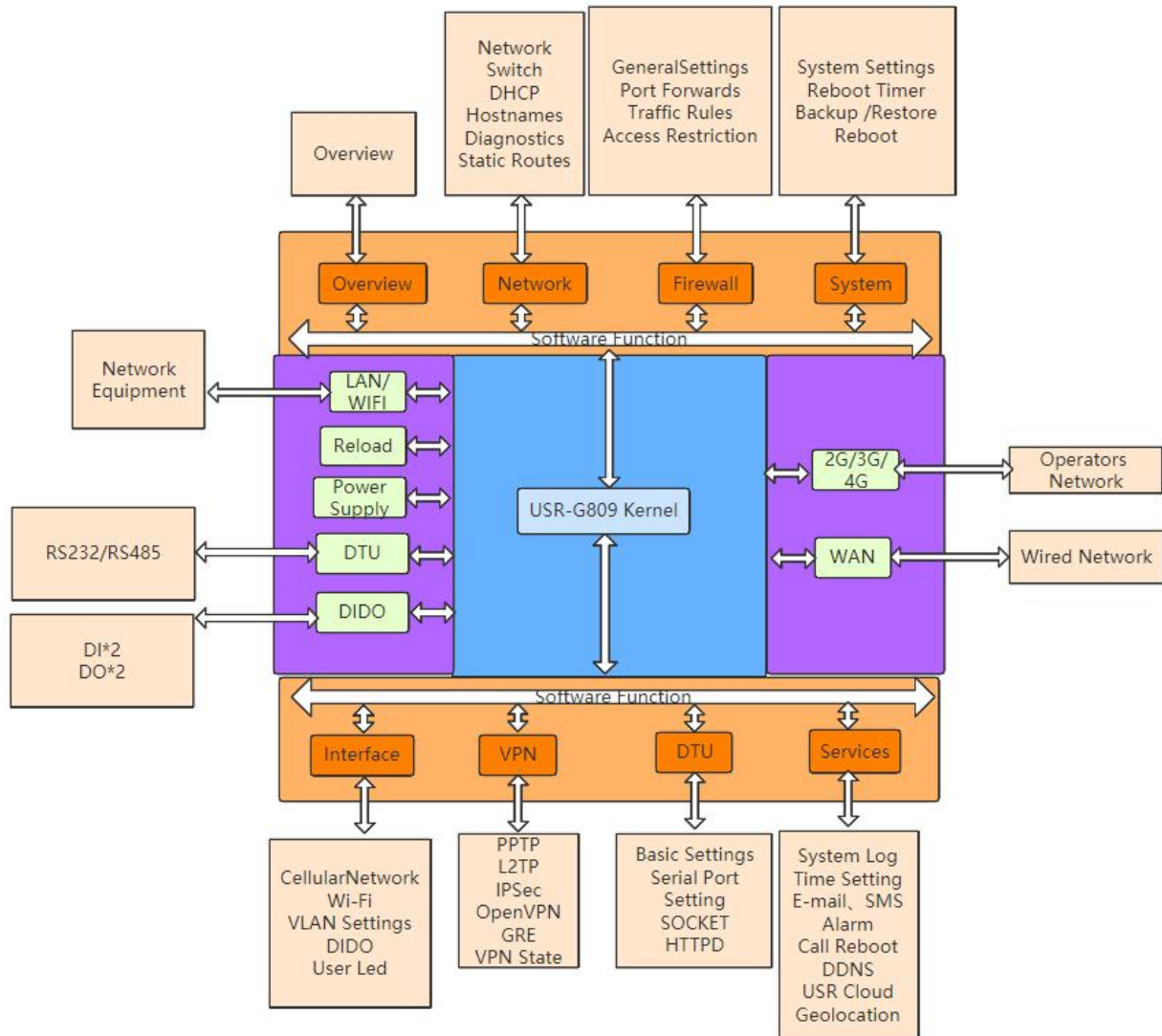

Network card	Code	Interface
LAN	br-lan	LAN
WIFI AP	br-lan	LAN
Wired WAN	eth0.2	WAN_WIRED
4G	eth1	WAN_4G

2.1. Web Interface

Connect PC to the LAN port of USR-G809 via a Ethernet cable, or directly connect the PC to the WiFi of the G809. Default parameters are as below:

Parameters	Default
SSID	USR-G809-XXXX
LAN IP address	192.168.1.1
Username	root
Password	root
WiFi password	www.pusr.com

Enter 192.168.1.1 in the browser to log into the webpage of USR-G809, username and password are both “root”, then click “Login”.

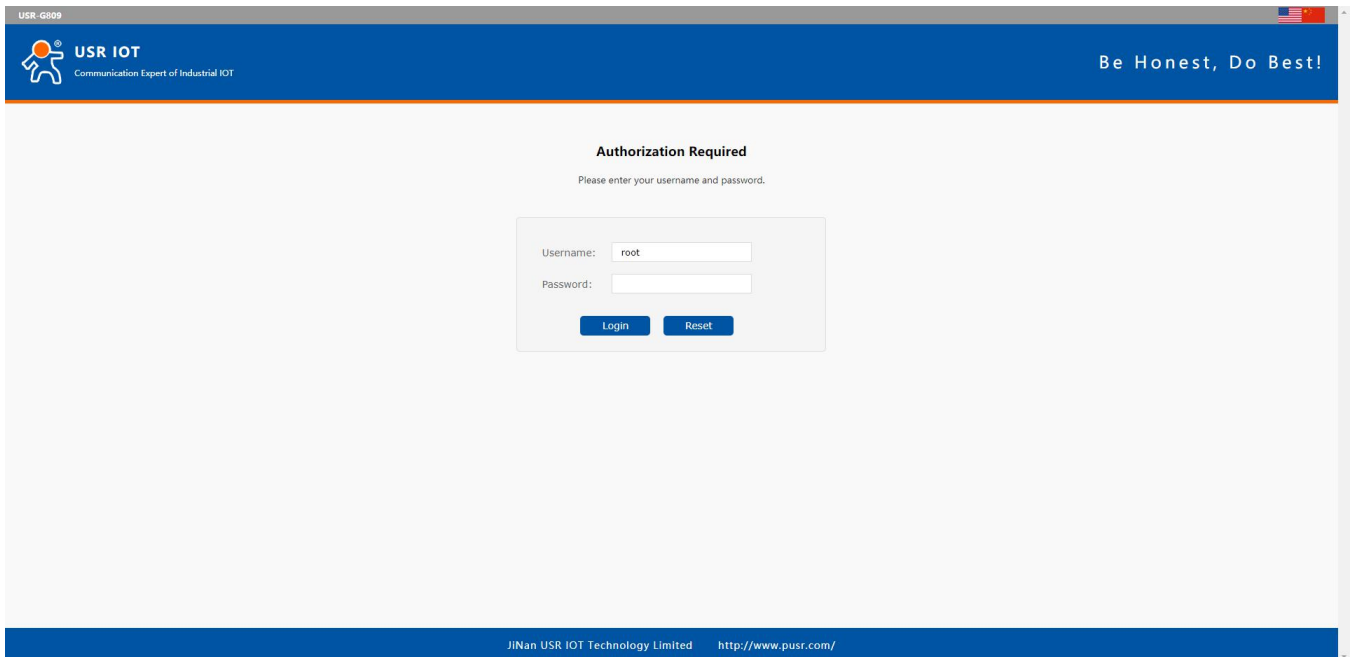

The screenshot shows the web interface of the USR-G809 device. At the top, there is a blue header with the USR IOT logo and the slogan "Be Honest, Do Best!". Below the header, the page title is "USR-G809". The main content area is titled "Authorization Required" and contains the instruction "Please enter your username and password." Below this, there is a login form with two input fields: "Username:" with the value "root" and "Password:". At the bottom of the form are two buttons: "Login" and "Reset". The footer of the page contains the text "Jinan USR IOT Technology Limited" and the URL "http://www.pusr.com/".

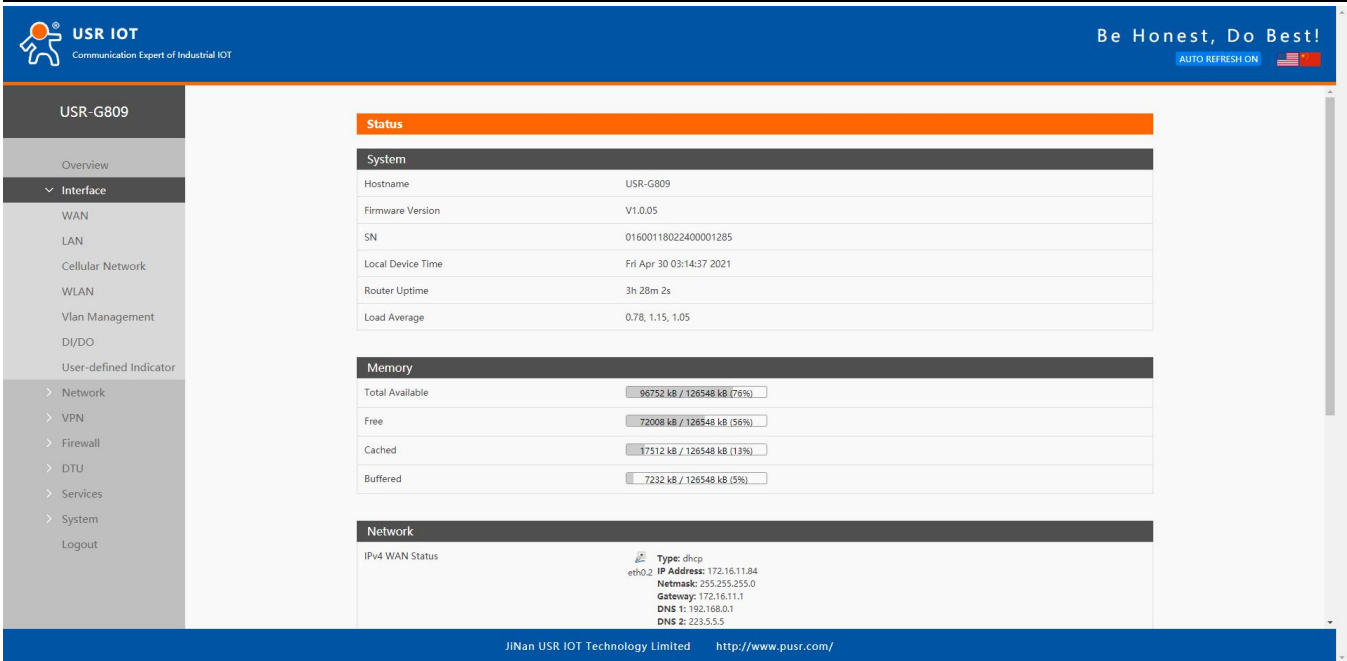

USR IOT Communication Expert of Industrial IOT

Be Honest, Do Best!

USR-G809

- Overview
- Interface
 - WAN
 - LAN
 - Cellular Network
 - WLAN
 - Vlan Management
 - DI/DO
 - User-defined Indicator
- Network
- VPN
- Firewall
- DTU
- Services
- System
 - Logout

Status

System

Hostname	USR-G809
Firmware Version	V1.0.05
SN	01600118022400001285
Local Device Time	Fri Apr 30 03:14:37 2021
Router Uptime	3h 28m 2s
Load Average	0.78, 1.15, 1.05

Memory

Total Available	96752 kB / 126548 kB (76%)
Free	72008 kB / 126548 kB (56%)
Cached	17512 kB / 126548 kB (13%)
Buffered	7232 kB / 126548 kB (5%)

Network

IPv4 WAN Status

Type	dhcp
eth0: IP Address	172.16.11.84
Netmask	255.255.255.0
Gateway	172.16.11.1
DNS 1	192.168.0.1
DNS 2	223.5.5.5

JINan USR IOT Technology Limited <http://www.pusr.com/>

2.2. Hostname

The hostname defaults to USR-G809 and the webpage port defaults to 80. After changing the parameters, click “Save&Apply”.

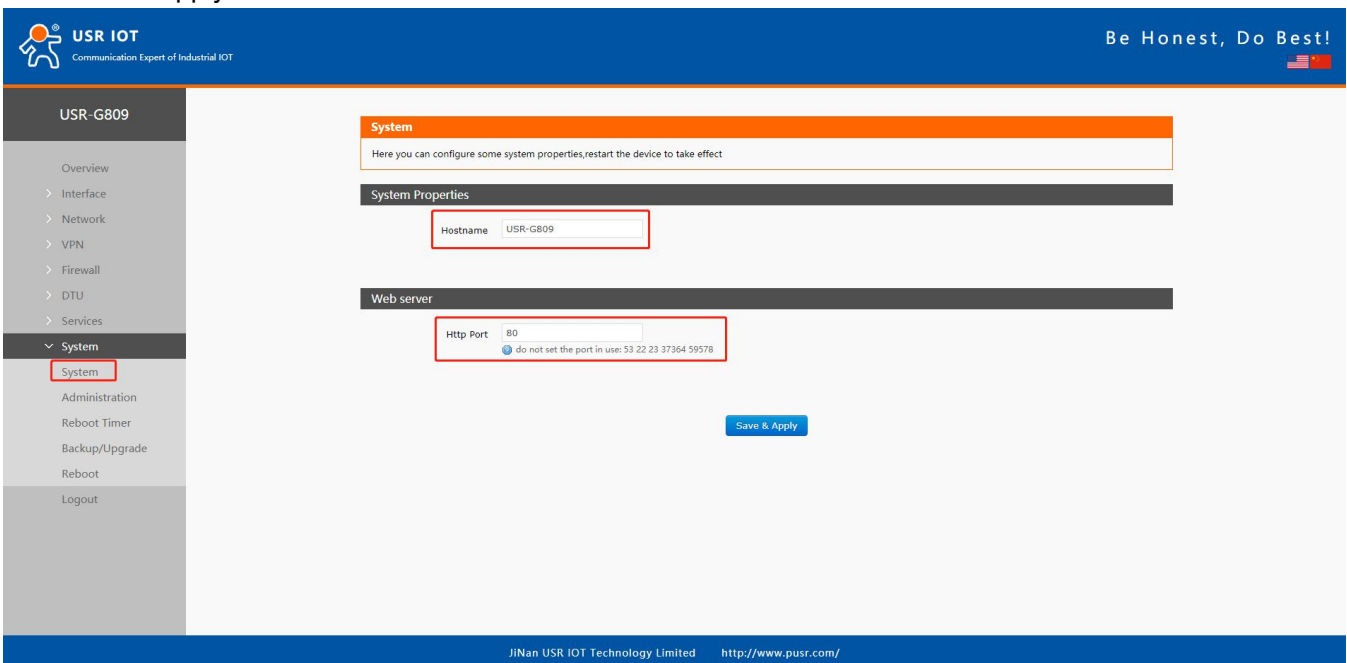

USR IOT Communication Expert of Industrial IOT

Be Honest, Do Best!

USR-G809

- Overview
- Interface
- Network
- VPN
- Firewall
- DTU
- Services
- System
 - System**
 - Administration
 - Reboot Timer
 - Backup/Upgrade
 - Reboot
 - Logout

System

Here you can configure some system properties, restart the device to take effect

System Properties

Hostname: USR-G809

Web server

Http Port: 80
 do not set the port in use: 53 22 23 37364 59578

Save & Apply

JINan USR IOT Technology Limited <http://www.pusr.com/>

2.3. User Password Settings

Username and password of USR-G809 default to “root”, password can be changed but the username is fixed. This password can be used to login via Web/telnet/ssh.

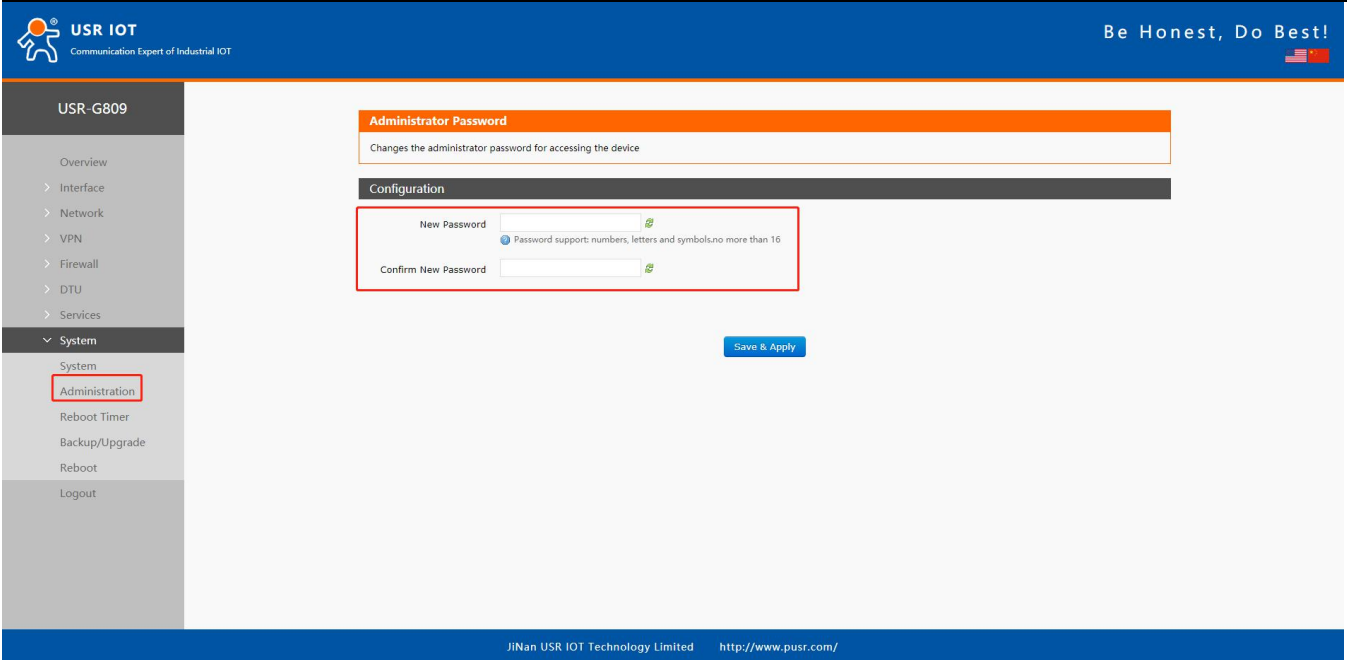

The screenshot shows the 'Administrator Password' configuration page in the USR-G809 web interface. The page title is 'Administrator Password' and the description is 'Changes the administrator password for accessing the device'. Under the 'Configuration' section, there are two input fields: 'New Password' and 'Confirm New Password'. A red box highlights these fields and a note below them: 'Password support: numbers, letters and symbols, no more than 16'. A 'Save & Apply' button is located at the bottom right of the configuration area. The left sidebar shows the navigation menu with 'Administration' selected and 'Reboot Timer' highlighted. The footer contains 'Jinan USR IOT Technology Limited' and 'http://www.pusr.com/'.

Note: It is recommended to change the original “root” password when login the router for the first time.

2.4. Reboot Timer

Users can restart the router at any time every day, every week and every month, and clear the running cache regularly to improve the running stability.

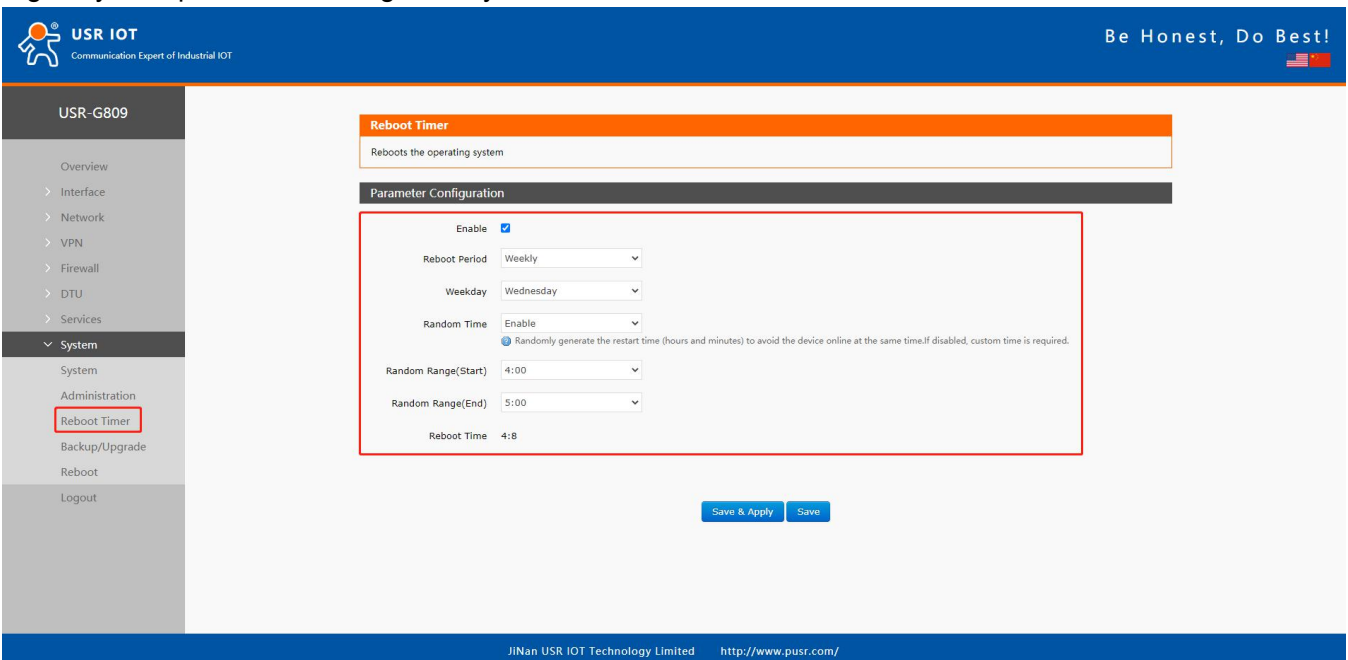

The screenshot shows the 'Reboot Timer' configuration page in the USR-G809 web interface. The page title is 'Reboot Timer' and the description is 'Reboots the operating system'. Under the 'Parameter Configuration' section, there are several settings: 'Enable' is checked, 'Reboot Period' is set to 'Weekly', 'Weekday' is set to 'Wednesday', 'Random Time' is set to 'Enable' with a note: 'Randomly generate the restart time (hours and minutes) to avoid the device online at the same time. If disabled, custom time is required.', 'Random Range(Start)' is set to '4:00', 'Random Range(End)' is set to '5:00', and 'Reboot Time' is set to '4:8'. A red box highlights the 'Enable', 'Reboot Period', 'Weekday', 'Random Time', and 'Random Range' settings. 'Save & Apply' and 'Save' buttons are located at the bottom right of the configuration area. The left sidebar shows the navigation menu with 'Administration' selected and 'Reboot Timer' highlighted. The footer contains 'Jinan USR IOT Technology Limited' and 'http://www.pusr.com/'.

2.5. Backup/Upgrade

In this interface, click “Export configuration file” to download the current parameter settings to a zip file, like backup-USR-G809-2020-08-09.tar.gz. Save and select this file, upload it to other devices to achieve batch configuration.

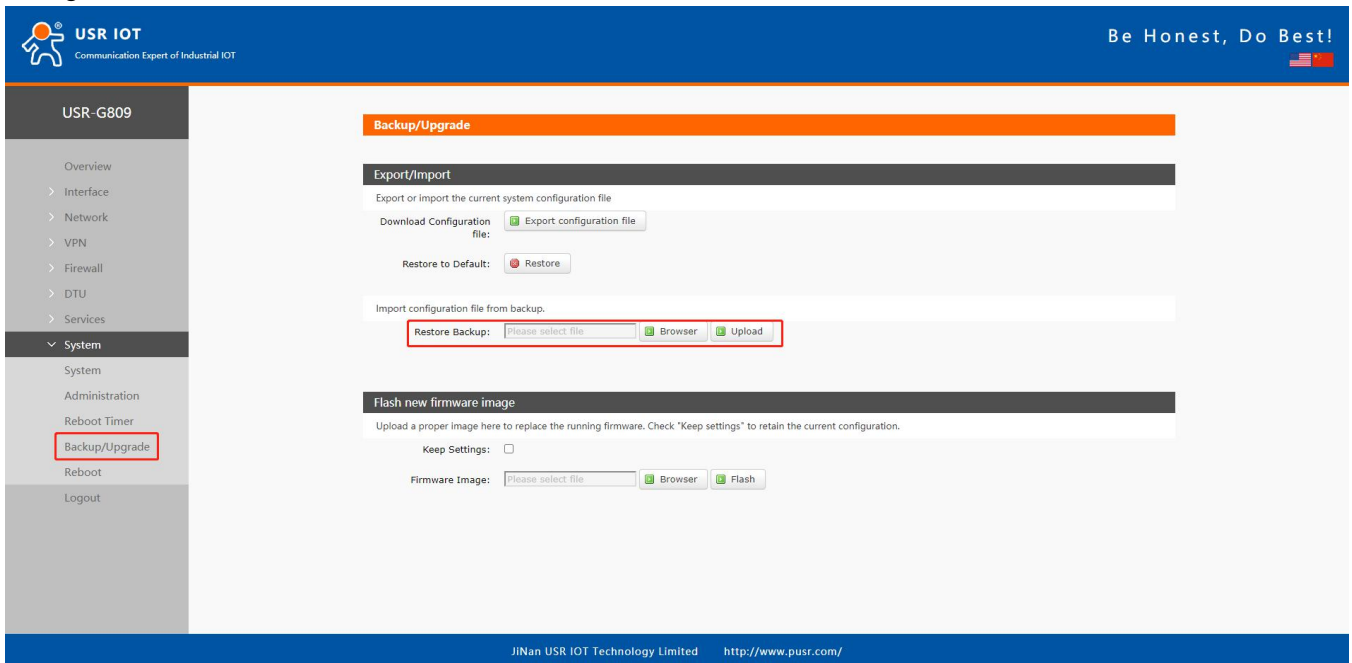

USR-G809 supports upgrading firmware via webpage, after selecting the bin file, click “Flash”. It will last about 3 minutes, please do not power off or disconnect the Ethernet cable during the upgrading. G809 defaults to upgrade without keeping the settings.

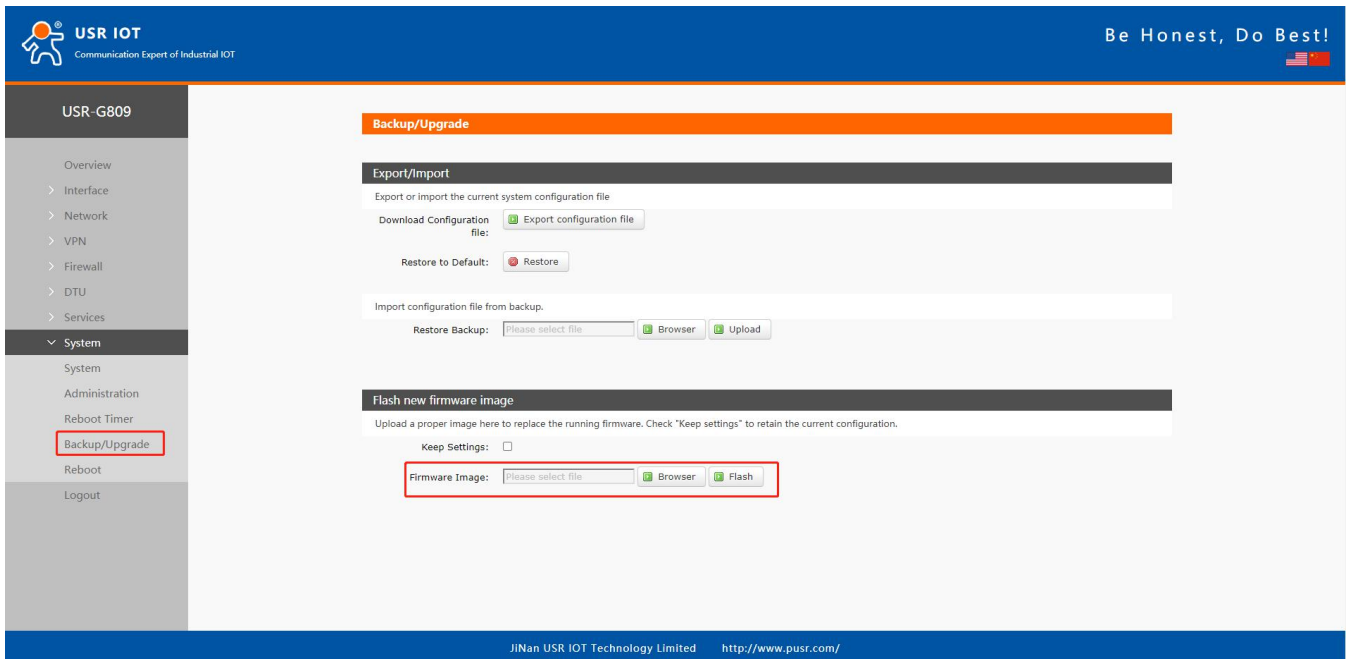

Users can also restore the device to factory settings via the “Restore” option.

2.6. Reboot

Click “Reboot” to restart the router, same as power off. Restarting takes about 90s.

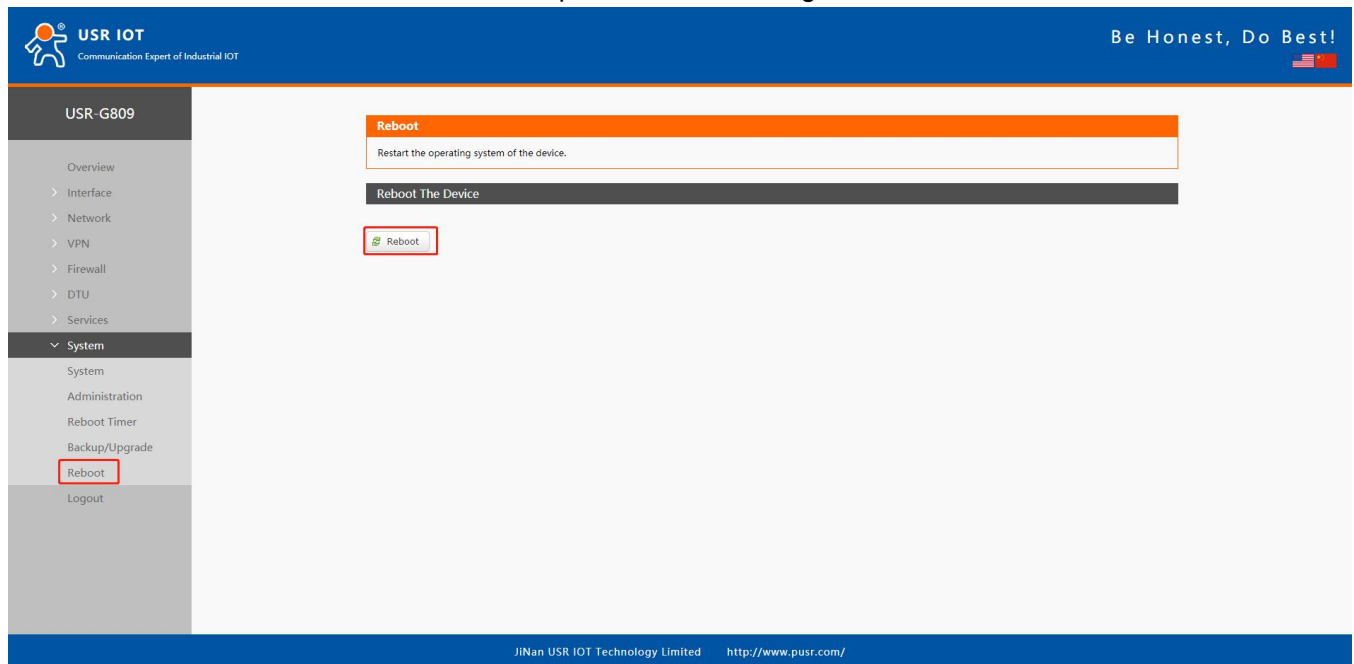

2.7. Reload Button

There is a “Reload” button in the device. Users can restore the device to factory settings, restore the firmware and upgrade firmware via this button.

2.7.1. Hardware Reset

Users can restore the device to factory settings via below steps:

1. Power on the device. PWR will be always on and the WORK indicator will flash every 1 sec.
2. Press and hold the “Reload” button for 3~15s under the normal operation of the system.
3. Release the button for 1~2s, all the indicator lights will flash once means the device has been reset.
4. The WORK indicator will flash after the device restarting.

2.7.2. Restore the Firmware

This function can restore the device to the original firmware.

1. Press and hold the “Reload” button before power on the device.
2. Hold the “Reload” button and power on the device at the same time, release it when the NET indicator flashes every 200ms.
3. Wait until all the indicator lights flash every 500ms, firmware is restoring now, please keep power on.
4. It will take about 2~3mins, firmware upgrade is completed when the WORK indicator flashes every 1s.

2.7.3. Upgrading via USB Port

USR-G809 supports upgrading via USB.

1. Place the firmware in the root directory of the U disk(FAT32 format).
2. Change the name of the firmware to “route_firmware.bin”.
3. Power off the device.
4. Insert the U disk to the USB port of the G809 device.
5. Press and hold the “Reload” button when the device is not powered on.
6. Press the “Reload” and power on the device simultaneously, release it when the NET indicator flashes every 200ms.
7. Wait until all the indicator lights flash every 500ms, firmware is upgrading now, please keep power on.
8. Upgrading will take 2~3mins, firmware upgrade is completed when the WORK indicator flashes every 1s.

Note: The file system only supports FAT32, with up to 32GB of memory.

3. Interface

Click “Interface”, can check the network cards status, WLAN, DIDO and other information.

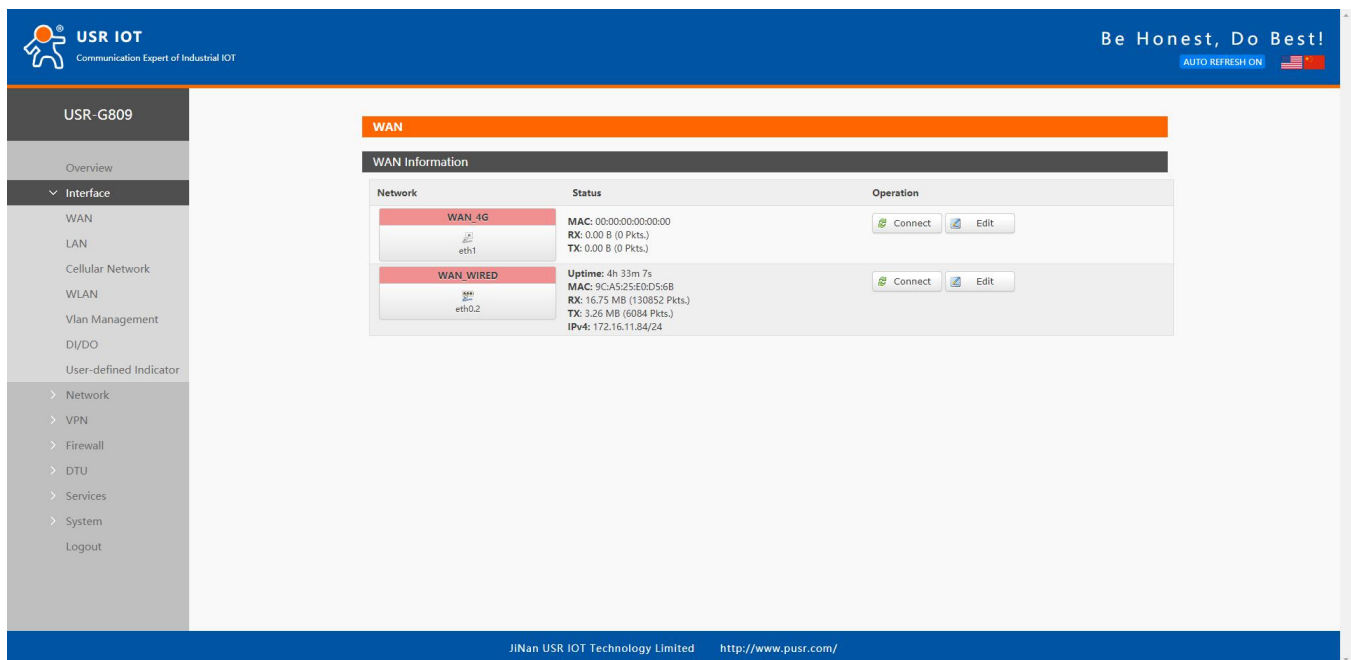

The screenshot shows the USR IOT web interface for the USR-G809 device. The main content area is titled "WAN" and "WAN Information". It displays a table with two rows of network interface information:

Network	Status	Operation
WAN_4G eth1	MAC: 00:00:00:00:00:00 RX: 0.00 B (0 Pkts.) TX: 0.00 B (0 Pkts.)	Connect Edit
WAN_WIRED eth0.2	Uptime: 4h 33m 7s MAC: 9C:A5:25:E0D5:6B RX: 16.75 MB (130852 Pkts.) TX: 3.26 MB (6084 Pkts.) IPv4: 172.16.11.84/24	Connect Edit

No.	Item	Description
1	Uptime	Time of this interface connected to the network.
2	MAC	MAC address of this interface.
3	RX/TX	Data received and sent of the this interface after connecting to the network.

4	IPv4	Indicates this interface use the IPV4 protocol.
---	------	---

3.1. WAN Interface

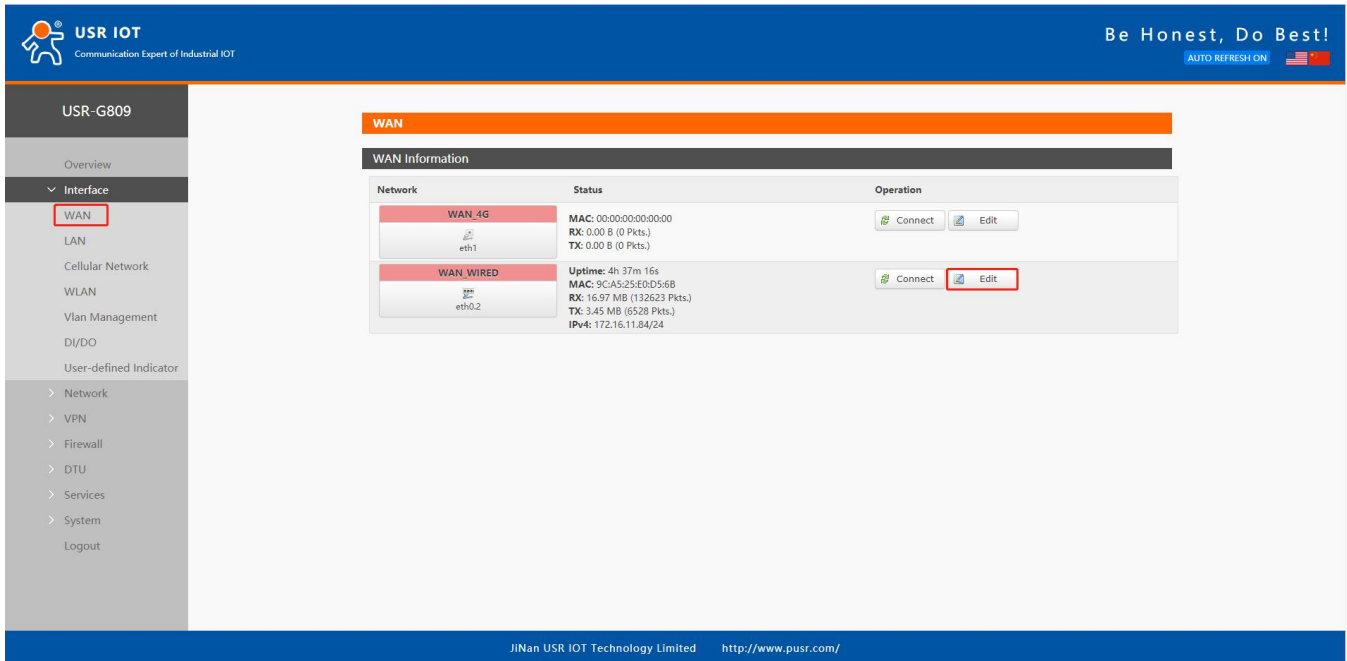

The screenshot shows the USR IOT web interface for the USR-G809 device. The left sidebar contains a navigation menu with 'Interface' expanded and 'WAN' selected. The main content area displays 'WAN Information' with a table of network interfaces:

Network	Status	Operation
WAN_4G eth1	MAC: 00:00:00:00:00:00 RX: 0.00 B (0 Pkts.) TX: 0.00 B (0 Pkts.)	Connect Edit
WAN_WIRED eth0.2	Uptime: 4h 37m 16s MAC: 9C:A5:25:E0:D5:6B RX: 16.97 MB (132623 Pkts.) TX: 3.45 MB (6528 Pkts.) IPv4: 172.16.11.84/24	Connect Edit

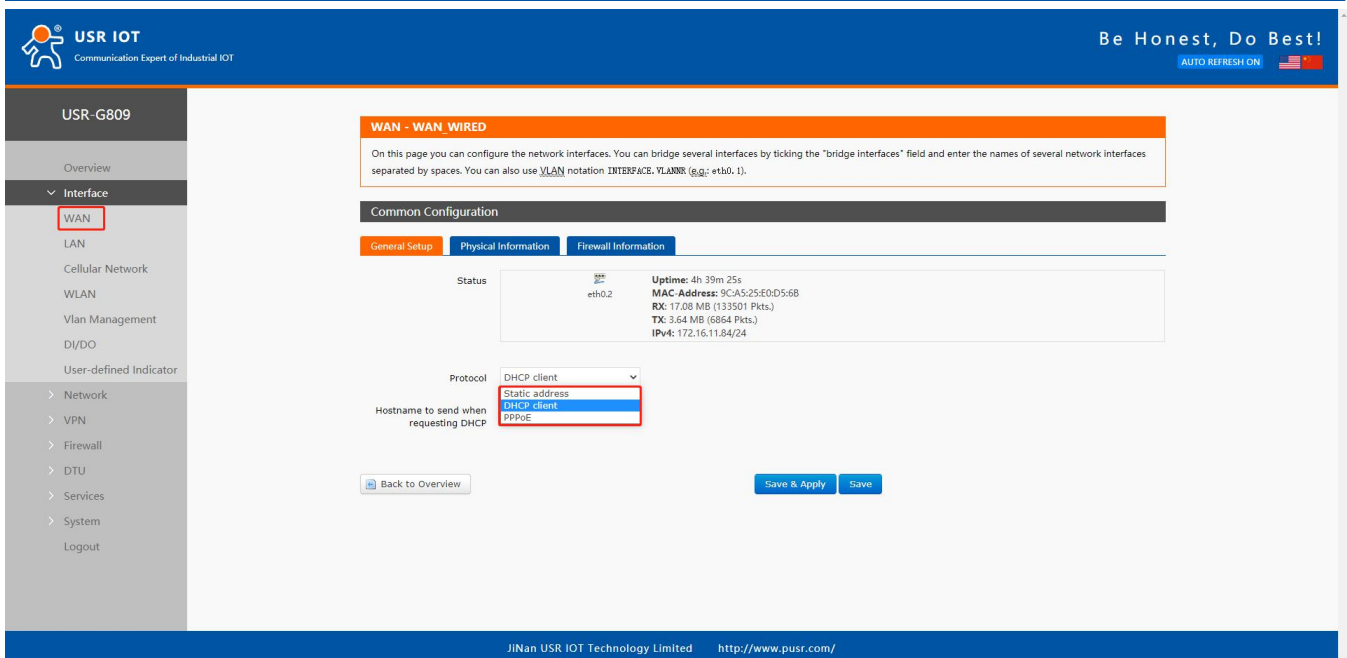

The screenshot shows the 'WAN - WAN WIRED' configuration page. It includes a 'Common Configuration' section with tabs for 'General Setup', 'Physical Information', and 'Firewall Information'. The 'General Setup' tab is active, showing the following configuration for the 'eth0.2' interface:

- Status: eth0.2
- Uptime: 4h 39m 25s
- MAC-Address: 9C:A5:25:E0:D5:6B
- RX: 17.08 MB (133501 Pkts.)
- TX: 3.64 MB (6864 Pkts.)
- IPv4: 172.16.11.84/24
- Protocol: DHCP client (selected)
- Hostname to send when requesting DHCP: DHCP client

Buttons for 'Back to Overview', 'Save & Apply', and 'Save' are visible at the bottom of the configuration area.

Description:

- WAN interface: supports DHCP client, static IP address and PPPoE protocol. Defaults to DHCP client.

3.2. LAN Interface

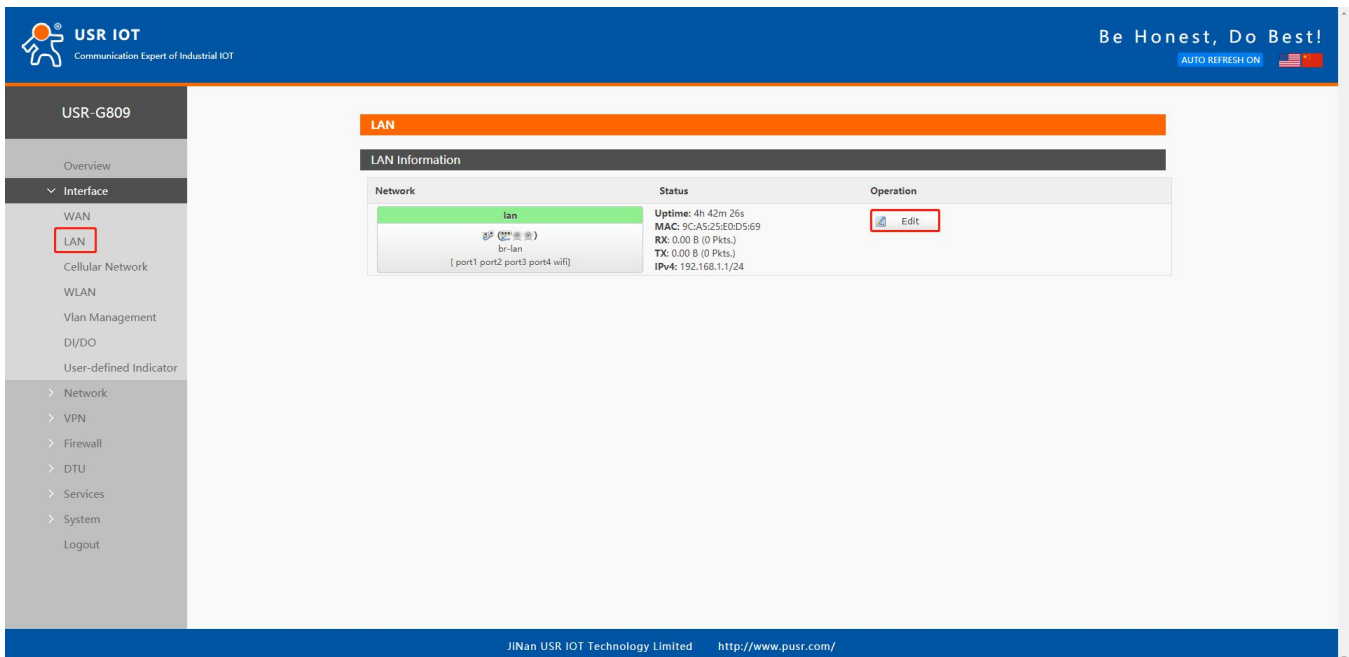

The screenshot shows the 'LAN' configuration page in the USR IOT web interface. The left sidebar contains a navigation menu with 'LAN' highlighted. The main content area shows the 'LAN Information' for the 'lan' interface, including its status and operation details. An 'Edit' button is visible next to the interface name.

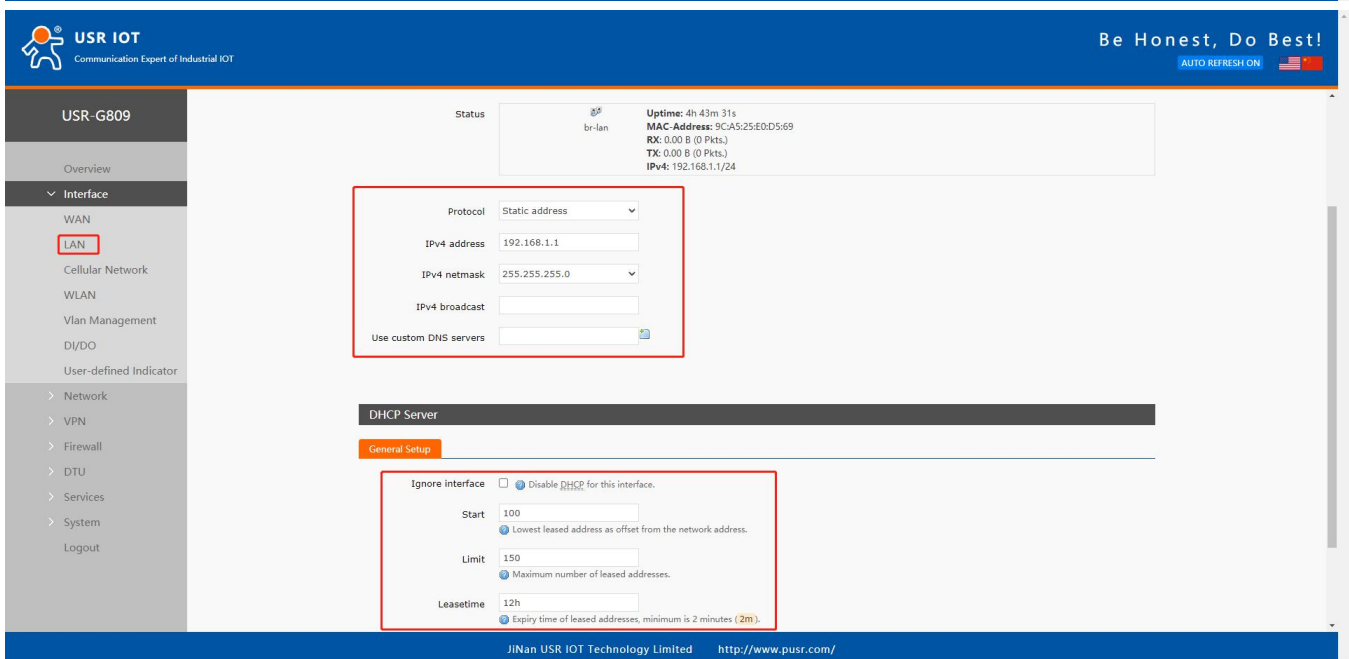

The screenshot shows the 'LAN' configuration page in the USR IOT web interface. The left sidebar contains a navigation menu with 'LAN' highlighted. The main content area shows the configuration options for the 'lan' interface, including the protocol, IP address, netmask, and broadcast address. Below this, the 'DHCP Server' section is visible, with the 'General Setup' tab selected. The DHCP settings include the 'Ignore interface' checkbox, 'Start' address, 'Limit' (maximum number of leased addresses), and 'Leasetime'.

Description:

- LAN interface: defaults to the IP address: 192.168.1.1, netmask 255.255.255.0. These parameters can be modified. You need to use the new IP address to log into the webpage of the device if you have changed it.
- WiFi interface (WLAN) and wired LAN are in the same LAN network.
- When enable DHCP server function, all the devices connect to the LAN port of G809 will get IP addresses automatically.
- You can change the start/end address, lease time of the DHCP addresses.
- The default IP address range for DHCP is 192.168.1.100 to 192.168.1.250. Default lease time is 12h.

3.3. Cellular Network Interface

USR-G809 supports one 4G/3G/2G interface to access the network.

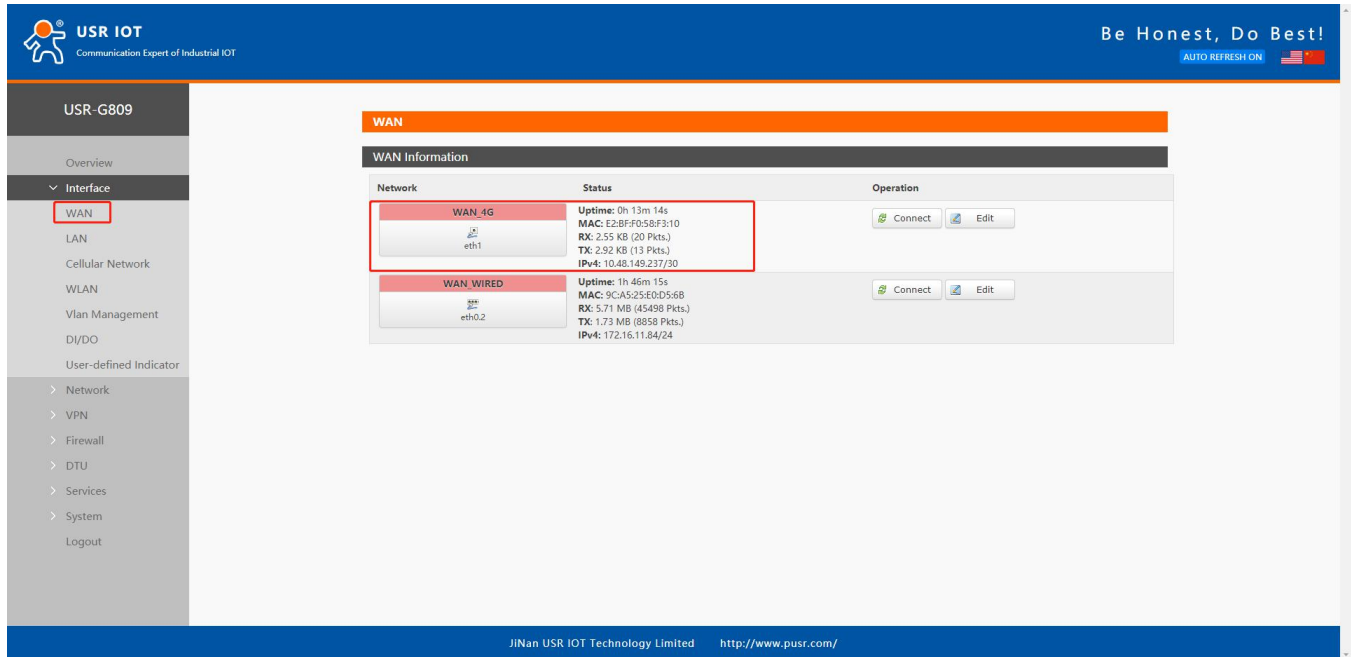

The screenshot displays the WAN configuration page in the USR IOT web interface. The left sidebar shows the navigation menu with 'WAN' selected. The main content area is titled 'WAN' and contains a 'WAN Information' section. This section lists two network interfaces:

Network	Status	Operation
WAN_4G eth1	Uptime: 0h 13m 14s MAC: E2BF05B:F3:10 RX: 2.55 KB (20 Pkts.) TX: 2.92 KB (13 Pkts.) IPv4: 10.48.149.237/30	Connect Edit
WAN_WIRED eth0.2	Uptime: 1h 46m 15s MAC: 9CA5:25:E0:D5:68 RX: 5.71 MB (45498 Pkts.) TX: 1.73 MB (8859 Pkts.) IPv4: 172.16.11.84/24	Connect Edit

3.3.1. Cellular Network Settings

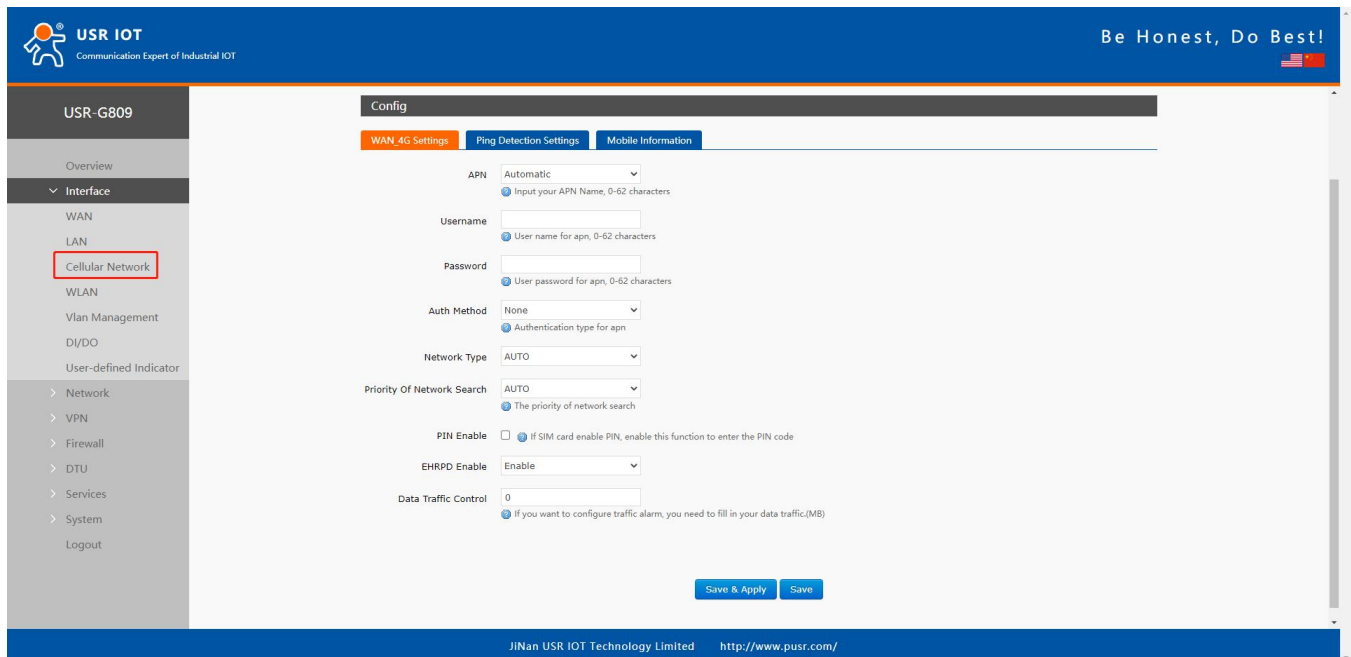

The screenshot displays the Cellular Network Settings page in the USR IOT web interface. The left sidebar shows the navigation menu with 'Cellular Network' selected. The main content area is titled 'Config' and contains the following settings:

- APN: Automatic (Input your APN Name, 0-62 characters)
- Username: (User name for apn, 0-62 characters)
- Password: (User password for apn, 0-62 characters)
- Auth Method: None (Authentication type for apn)
- Network Type: AUTO
- Priority Of Network Search: AUTO (The priority of network search)
- PIN Enable: (If SIM card enable PIN, enable this function to enter the PIN code)
- EHRPD Enable: Enable
- Data Traffic Control: 0 (If you want to configure traffic alarm, you need to fill in your data traffic.(MB))

Please set the APN parameters here if the device cannot connect to the network automatically.

Item	Description	Default
APN	Please set the correct APN address.	Autocheck
Username	APN username	None

Password	APN password	None
Auth Method	APN authentication type: None/PAP/CHAP	None
Network Type	Force 4G, 3G or 2G network	AUTO
Priority of network search	Can set the priority of the network	AUTO
PIN Enable	Enable: Fill in the pin code of the SIM card.	Disable
EHRPD Enable	Enable/Disable	Disable
Data traffic control	0: Disable traffic alarm. Other values: alarm when the traffic consumption reaches this value.	0

3.3.2. Ping Detection Settings

Ping detection is used to check the network status of the device, defaults to be disabled. After enable this function, the device will try to ping the set address, dial again after reaching consecutive failures times. It is recommended to enable the ping detection function to avoid being kicked by the base station if the device will not transmit data for a long time.

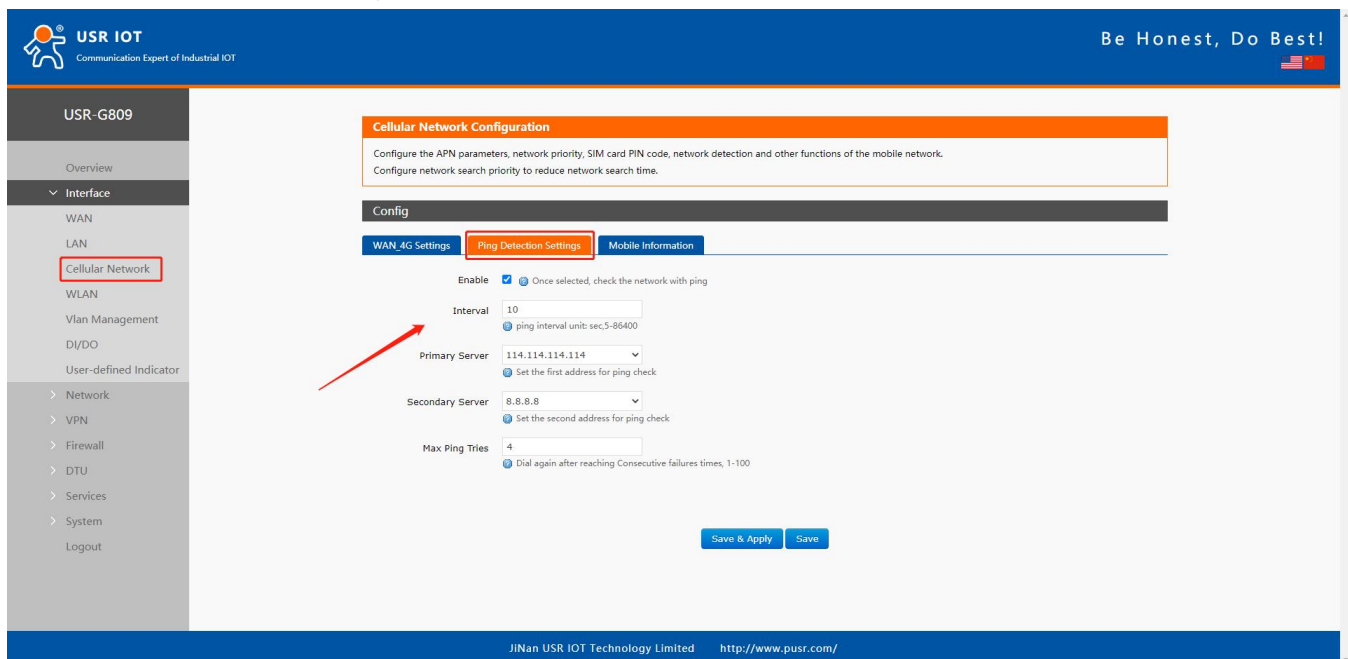

3.3.3. Mobile Information

Users can check the detailed configure information of the SIM card.

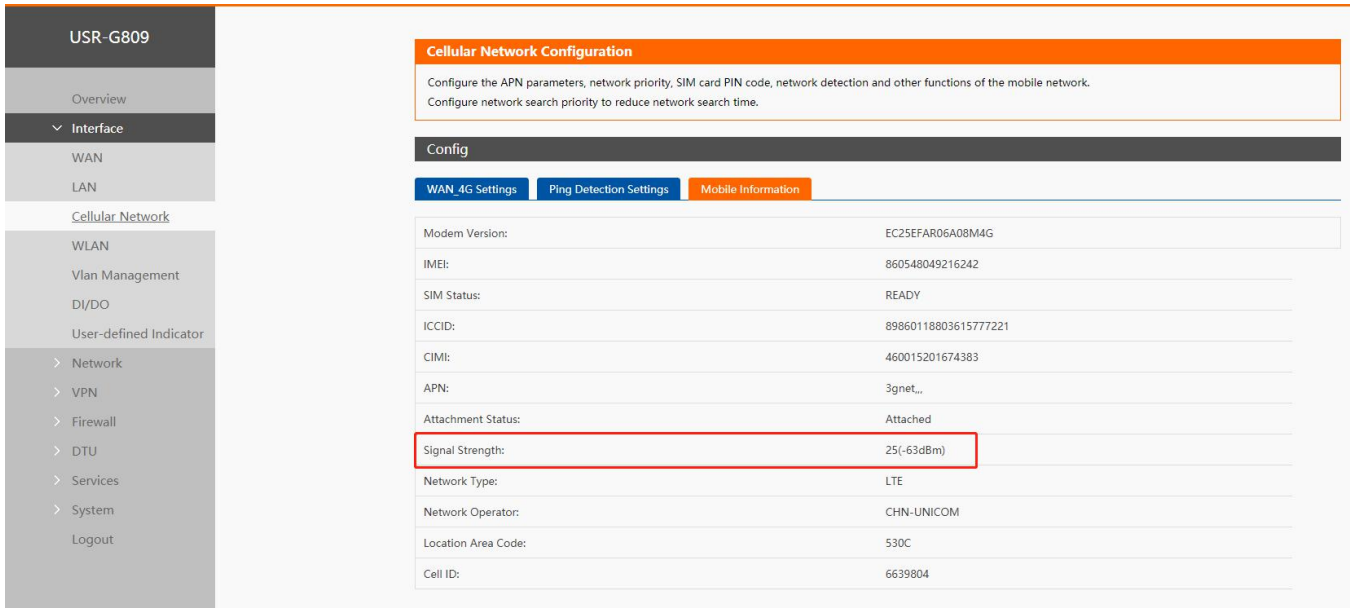

Cellular Network Configuration

Configure the APN parameters, network priority, SIM card PIN code, network detection and other functions of the mobile network.
Configure network search priority to reduce network search time.

Config

WAN 4G Settings | Ping Detection Settings | **Mobile Information**

Modem Version:	EC25EFAR06A08M4G
IMEI:	860548049216242
SIM Status:	READY
ICCID:	89860118803615777221
CIMI:	460015201674383
APN:	3gnet...
Attachment Status:	Attached
Signal Strength:	25(-63dBm)
Network Type:	LTE
Network Operator:	CHN-UNICOM
Location Area Code:	530C
Cell ID:	6639804

Description:

- Signal strength, the unit is dBm and asu. $\text{dBm} = -113 + 2 * \text{asu}$.
- USR-G809 supports display via dBm and asu. In 25(-63 dBm), 25 is the asu value. The range of asu is 0~31, the higher the value, the better the signal strength.

3.4. WLAN Interface

USR-G809 supports WiFi-AP function, 2.4GHz WiFi network. Users can modify the WiFi parameters in below interface.

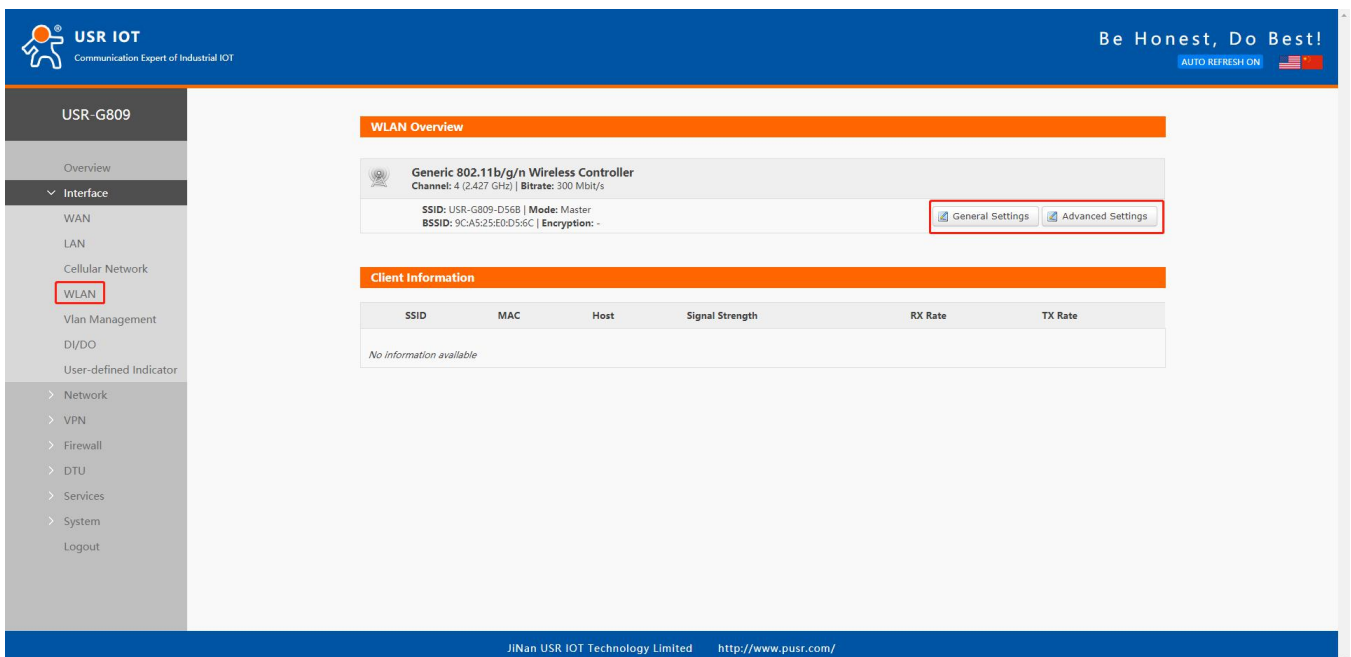

WLAN Overview

Generic 802.11b/g/n Wireless Controller
 Channel: 4 (2.427 GHz) | Bitrate: 300 Mbit/s

SSID: USR-G809-D568 | Mode: Master
 BSSID: 9C:A5:25:E0:D5:6C | Encryption: -

[General Settings](#) [Advanced Settings](#)

Client Information

SSID	MAC	Host	Signal Strength	RX Rate	TX Rate
No information available					

Description:

- USR-G809 is an access point, other station devices can connect to its WiFi. It supports up to 20 WiFi stations.

➤ The maximum WiFi range is 100m in the open area, and within 40m in the office with obstacles.

Item	Description	Default
ESSID	Network name of the WiFi, can be modified.	USR-G809-8899 (8899=the last 4 bits of the MAC)
Mode	Access Point	AP
Hide ESSID	Enable: None of client could scan the SSID. If you want to connect to the router AP, must enter the ESSID at WiFi client side manually. Disable: Enable the SSID broadcasting. So that the client can scan the SSID.	Disable
Encryption	WPA2-PSK/WPA-PSK/No Encryption	WPA2-PSK
Cipher	CCMP/TKIP/CCMP&TKIP	CCMP
Key	WiFi password, can be modified.	www.pusr.com
Radio Enable/Disable	Enable: open WiFi radio, AP can be used. Disable: close WiFi radio, AP cannot be used, "WLAN" indicator light will be off.	Enable
Network Mode	802.11b/g/n	802.11b/g/n
Channel	Auto, can be selected.	Auto
Bandwidth	40MHz/20MHz	40MHz
Regions	Optional	none
Channel	Optional	CH1~11

In "WLAN---General Settings", we can change the SSID and password.

USR IOT
Communication Expert of Industrial IOT

Be Honest, Do Best!

USR-G809

Overview

Interface

WAN

LAN

Cellular Network

WLAN

Vlan Management

DI/DO

User-defined Indicator

Network

VPN

Firewall

DTU

Services

System

Logout

Wireless Network: Master "USR-G809-D56B" (ra0)

The Device Configuration section covers physical settings of the radio hardware.

Interface Configuration

Basic settings Wireless Security

ESSID USR-G809-D56B

Mode Access Point

Hide ESSID

Save & Apply Save

Jinan USR IOT Technology Limited <http://www.pusr.com/>

In "WLAN---Advanced Settings", we can enable/disable the WiFi radio.

USR IOT
Communication Expert of Industrial IOT

Be Honest, Do Best!

AUTO REFRESH ON

USR-G809

Overview

Interface

WAN

LAN

Cellular Network

WLAN

Vlan Management

DI/DO

User-defined Indicator

Network

VPN

Firewall

DTU

Services

System

Logout

Wireless Network: Master "USR-G809-D56B" (ra0)

The Device Configuration section covers physical settings of the radio hardware.

Physical Configuration

General Settings Advanced Settings

Status Mode: Master | SSID: USR-G809-D56B
BSSID: 9C:A5:25:E0D5:6C
Channel: 3 (2.422 GHz) | Bitrate: 300.0 Mbit/s

Radio Enable/Disable Enable

Network Mode 802.11b/g/n

Channel auto

Bandwidth 40MHz

Save & Apply Save

Jinan USR IOT Technology Limited <http://www.pusr.com/>

We can check the WiFi client information in below interface:

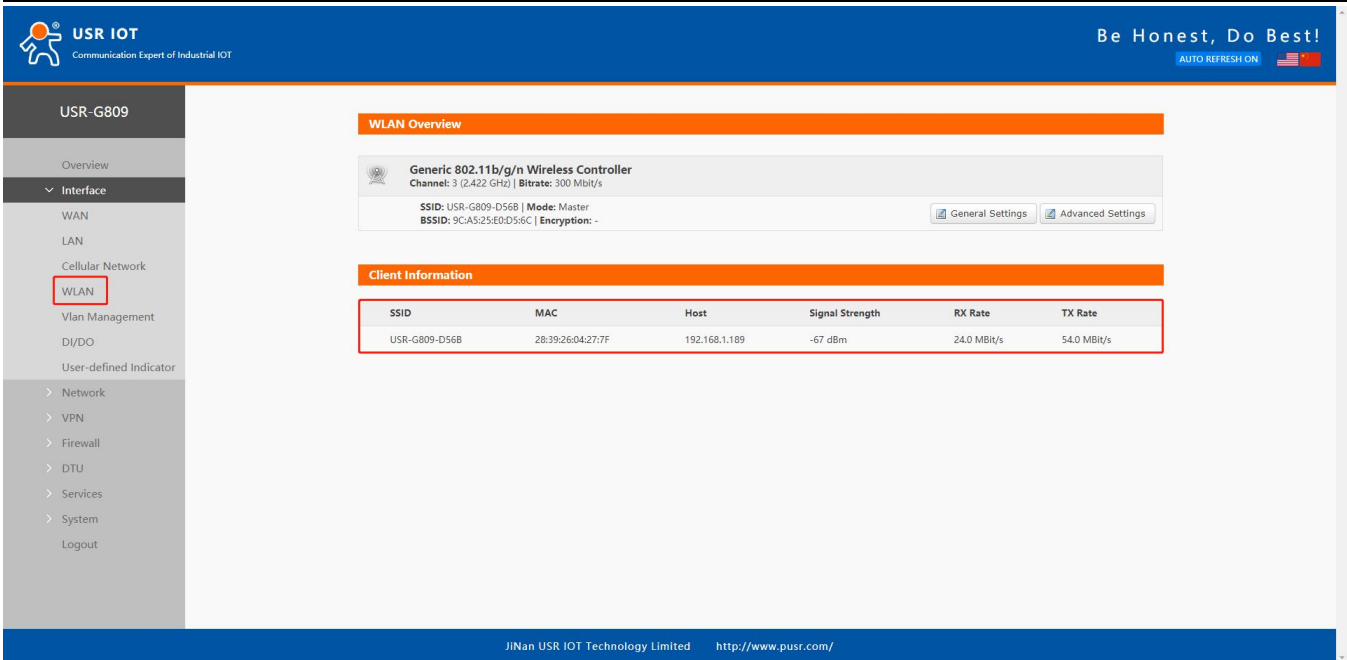

The screenshot shows the USR IOT web interface. The left sidebar has 'WLAN' highlighted. The main content area is titled 'WLAN Overview' and shows 'Generic 802.11b/g/n Wireless Controller' with details like Channel: 3 (2.422 GHz) and Bitrate: 300 Mbit/s. Below this is a 'Client Information' table:

SSID	MAC	Host	Signal Strength	RX Rate	TX Rate
USR-G809-D56B	28:39:26:04:27:7F	192.168.1.189	-67 dBm	24.0 MBit/s	54.0 MBit/s

3.5. VLAN

USR-G809 supports VLAN function. 4 LAN ports can be divided into multiple VLAN interfaces. If enable VLAN function, LAN IP address will be changed to 192.168.1.1 automatically, and LAN 2 will be 192.168.2.1 and so on.

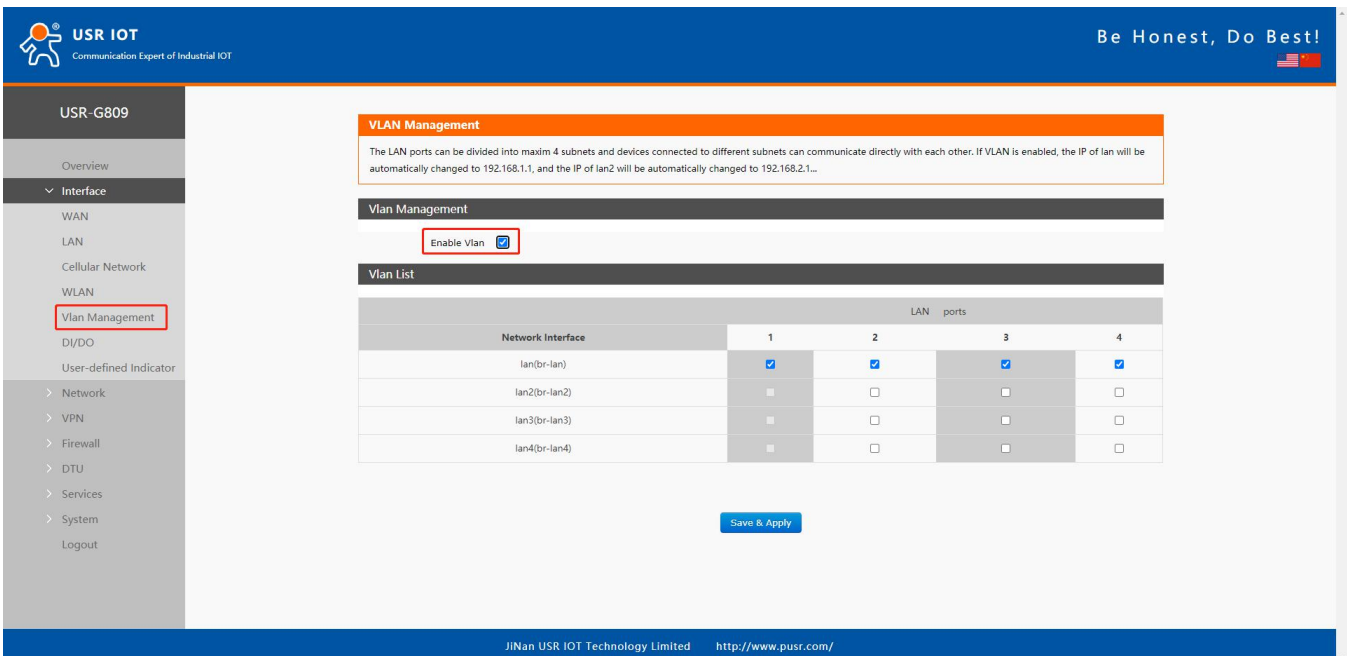

The screenshot shows the 'VLAN Management' section of the USR IOT web interface. It includes a descriptive text box, an 'Enable Vlan' checkbox (checked), and a 'Vlan List' table:

Network Interface	LAN ports			
	1	2	3	4
lan(br-lan)	<input checked="" type="checkbox"/>	<input checked="" type="checkbox"/>	<input checked="" type="checkbox"/>	<input checked="" type="checkbox"/>
lan2(br-lan2)	<input type="checkbox"/>	<input type="checkbox"/>	<input type="checkbox"/>	<input type="checkbox"/>
lan3(br-lan3)	<input type="checkbox"/>	<input type="checkbox"/>	<input type="checkbox"/>	<input type="checkbox"/>
lan4(br-lan4)	<input type="checkbox"/>	<input type="checkbox"/>	<input type="checkbox"/>	<input type="checkbox"/>

A 'Save & Apply' button is located below the table.

Item	Description	Default
Enable VLAN	--	Disable
LAN 1 interface	Cannot modify.	lan
LAN 2 interface	Can choose between lan~lan4.	lan
LAN 3 interface	Can choose between lan~lan4.	lan
LAN 4 interface	Can choose between lan~lan4.	lan

Note:

- WIFI is in lan interface, when connecting to the WIFI of G809 device, will get the IP address in the same network segment with “br-lan”.
- Users can change the network segment of VLAN in “Interface--LAN”.

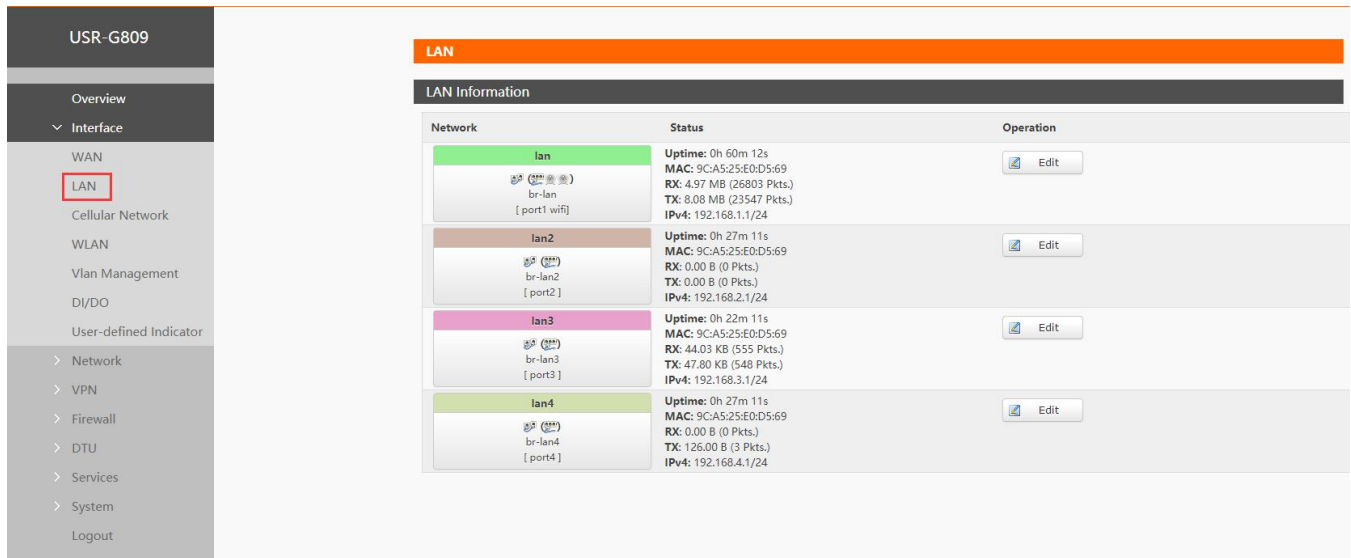

Network	Status	Operation
lan br-lan [port1 wifi]	Uptime: 0h 60m 12s MAC: 9CA5:25:E0:D5:69 RX: 4.97 MB (26803 Pkts.) TX: 8.08 MB (23547 Pkts.) IPv4: 192.168.1.1/24	Edit
lan2 br-lan2 [port2]	Uptime: 0h 27m 11s MAC: 9CA5:25:E0:D5:69 RX: 0.00 B (0 Pkts.) TX: 0.00 B (0 Pkts.) IPv4: 192.168.2.1/24	Edit
lan3 br-lan3 [port3]	Uptime: 0h 22m 11s MAC: 9CA5:25:E0:D5:69 RX: 44.03 KB (555 Pkts.) TX: 47.80 KB (548 Pkts.) IPv4: 192.168.3.1/24	Edit
lan4 br-lan4 [port4]	Uptime: 0h 27m 11s MAC: 9CA5:25:E0:D5:69 RX: 0.00 B (0 Pkts.) TX: 126.00 B (3 Pkts.) IPv4: 192.168.4.1/24	Edit

3.6. DIDO

USR-G809 has DI and DO hardware interface. DI can be used to trigger the alarm, and the DO can be used to control the device according to the trigger condition.

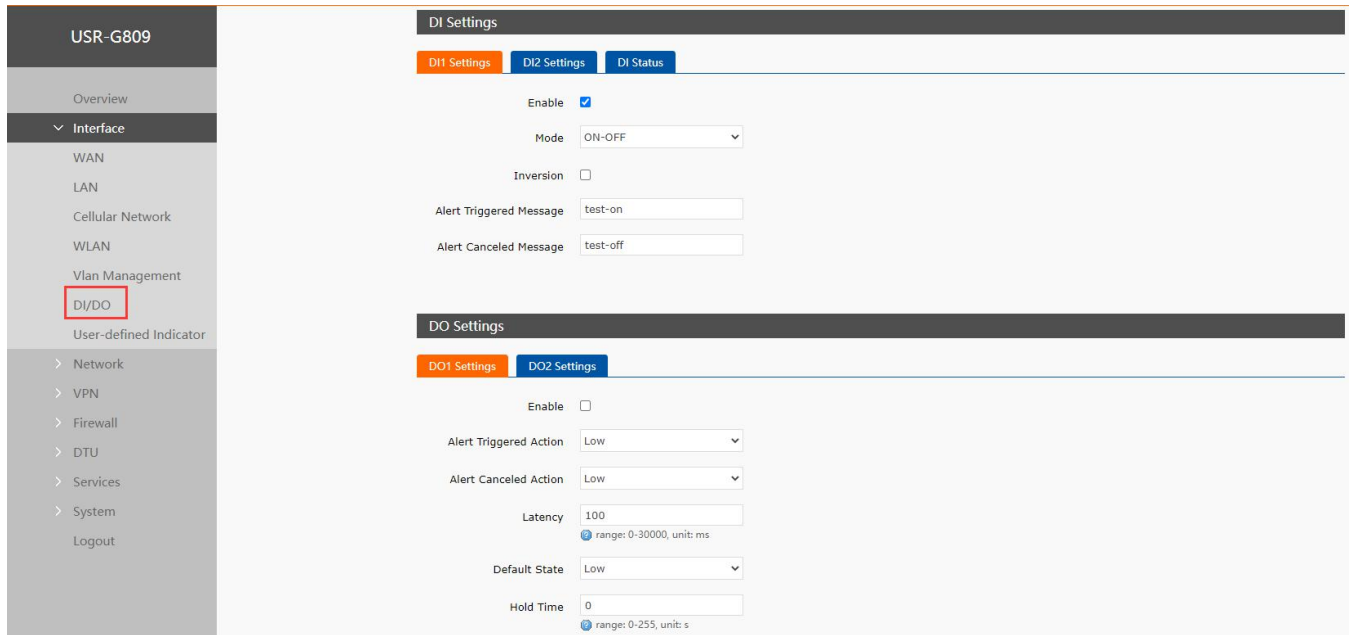

3.6.1. Connecting Hardware

3.6.1.1. DI Hardware Connection

DI*2: Dry contact, volt-free contact, can operate as an ordinary ON/OFF switch. It is nonpolar, adaptable to different wiring.

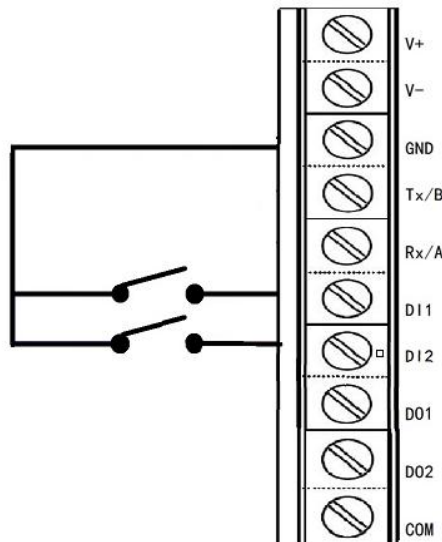

3.6.1.2. DO Hardware Connection

DO*2: Wet contact, active contact, can operate like a controlled switch. It is polar, and the wiring cannot be reversed.

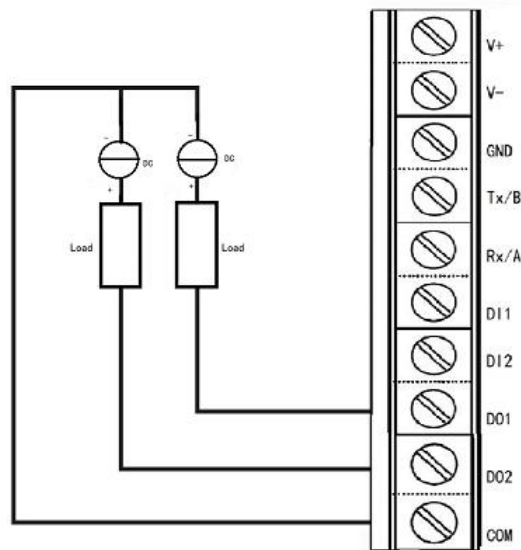

3.6.2. DI Configuration

There are two DI interfaces in G809 device.

Item	Description	Default
Enable	Check: Enable DI function	Disable
Mode	ON-OFF: DI level will trigger the alarm. <ul style="list-style-type: none"> ● High level triggers alarm ● Low level triggers alarm Counter: DI in event counter mode. <ul style="list-style-type: none"> ● Counting rising edges 	ON-OFF
Inversion	When checking "Inversion": In ON-OFF mode, low level triggers alarm; In Counter mode, counting falling edges.	Uncheck
Alert triggered message	Alert message sent after DI triggered.	None
Alert canceled message	Alert message sent after DI trigger canceled.	None

Note: When in counter mode, counting continues instead of zeroing out when the trigger value is reached.

3.6.3. DO Configuration

There are two DO interfaces in G809 device.

Item	Description	Default
Enable	Check: Enable DO function.	Disable
Alert triggered action	Can set to "High", "Low", "Pulse".	Low
Alert canceled action	Can set to "High", "Low", "Pulse".	Low
Latency (Unit: ms)	DO output alert delayed, set to 0 means output alert immediately. (Can set to 0~30000ms)	100
Default state	Default level of DO, can be set to "High" or "Low".	Low

Hold time (Unit: s)	Duration of the DO action, only valid in “High” and “Low” of the alert triggered action. 0 means until the next action, and other values represent the duration of the DO action (0~255s can be set).	0
Low level width(Units: s)	Valid when the alert triggered action is “Pulse”, the low level duration of this DO action can be set to 0~30000ms.	1000
High level width(Unit: s)	Valid when the alert triggered action is “Pulse”, the high level duration of this DO action can be set to 0~30000ms.	1000
Alert source	DI1 or DI2 which triggers the action of this DO.	DI1

Note: The maximum voltage of DO is 36V, overcurrent protection is 300mA.

3.7. User-defined Indicator

Users can define the “USR” indicator according to the requirements.

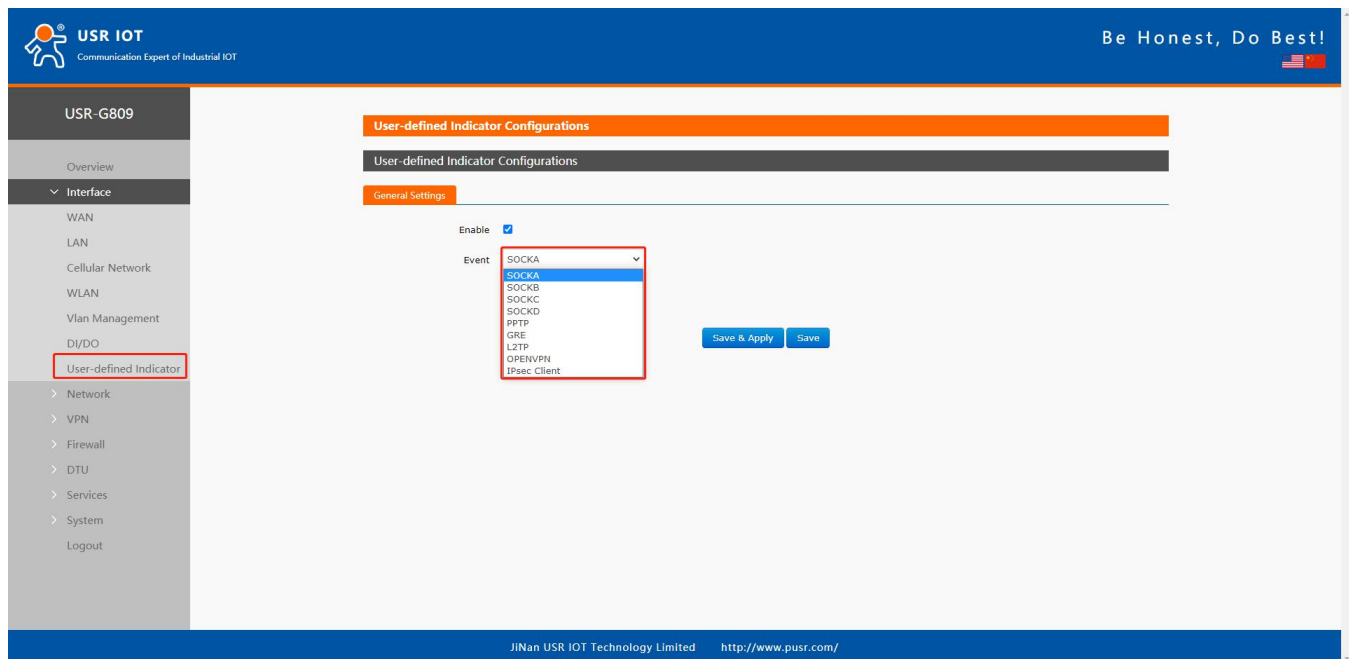

Item	Description	Default
Enable	Enable/Disable	Disable
Event	SOCKA~D、pptp、l2tp、gre、openvpn、ipsec	SOCKA

Note:

- SOCK: The light will be on when socket connection is established.
- VPN: The light will be on when the VPN connection is established, only valid in Client mode(IPSEC).
- TCPS: On when connecting to the clients.
- TCPC/HTTPD: On when connecting to the server.
- UDPC/UDPS: On when the socket connection is established.

4. Network

4.1. Network Switch

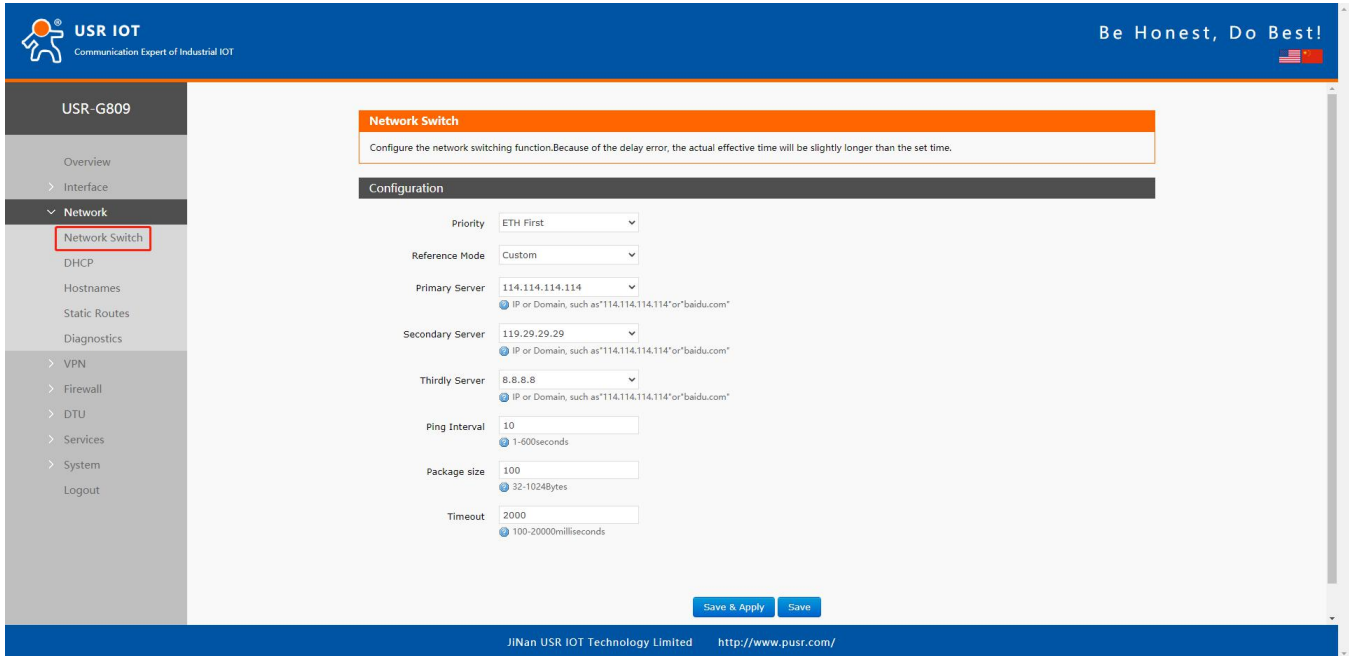

Item	Description	Default
Priority	ETH First: Select to make WAN Ethernet port as the primary link. 4G First: Select to make SIM card as the primary wireless link. Disable: disable network switch function, access the network with current link.	ETH First
Reference Mode	Custom: Router will ping the custom reference address/domain name to check that if the current connectivity is active. Gateway: Router will ping the gateway to check if the current connectivity is active.	Custom
Primary Server	IP address/domain name	114.114.114.114
Secondary Server	IP address/domain name	119.29.29.29
Thirdly Server	IP address/domain name	8.8.8.8
Ping interval (s)	Set the ping interval, 1-600s.	10
Package size(byte)	Set the ping package size, 32-1024 bytes.	100
Timeout (ms)	Ping timeout, 100-20000ms	2000

Note: Router will ping the reference addresses one by one, it will not switch the network if can ping successfully.

4.2. DHCP

Static address assignment: In “Network -- DHCP”, we can assign a fixed IP address to a DHCP client device. User can bind the MAC address with a fixed IP address, up to 20 binding rules can be added.

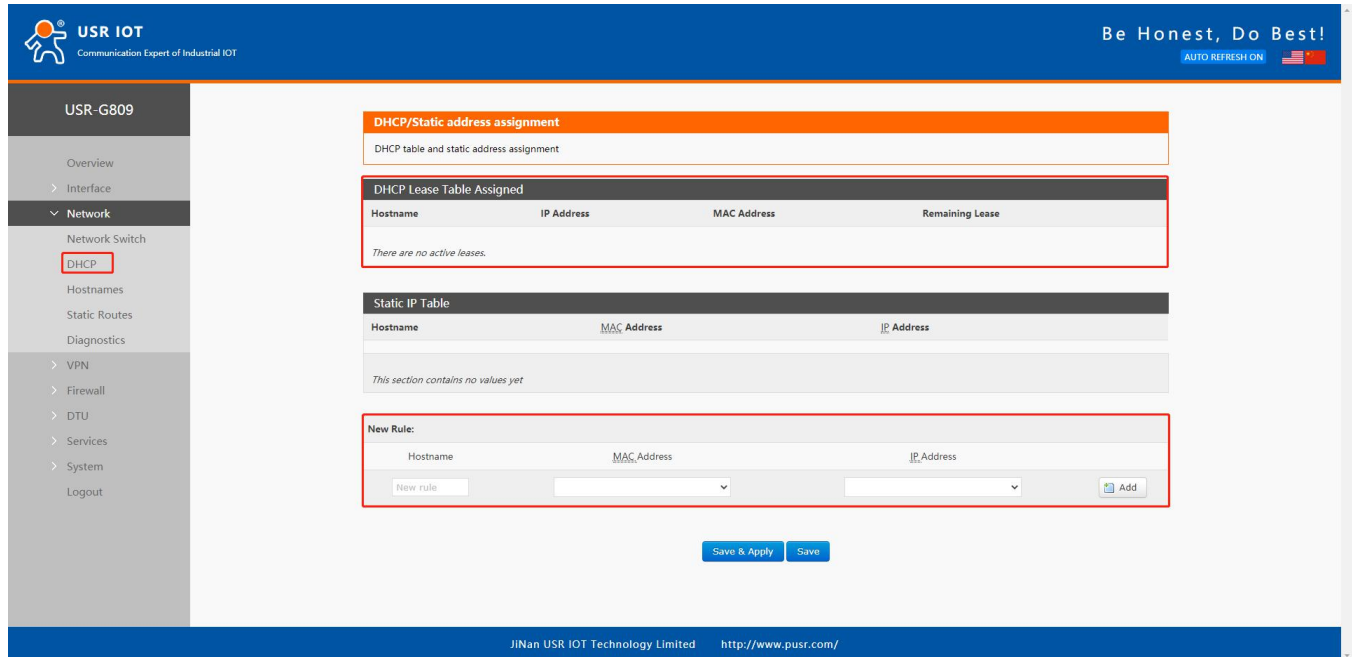

The screenshot shows the USR-G809 web interface for DHCP/Static address assignment. The left sidebar contains a navigation menu with 'DHCP' highlighted. The main content area is divided into three sections:

- DHCP/Static address assignment:** A header section with a sub-header 'DHCP table and static address assignment'.
- DHCP Lease Table Assigned:** A table with columns: Hostname, IP Address, MAC Address, and Remaining Lease. Below the table, it states 'There are no active leases.'
- Static IP Table:** A table with columns: Hostname, MAC Address, and IP Address. Below the table, it states 'This section contains no values yet.'

At the bottom, there is a 'New Rule:' section with input fields for Hostname, MAC Address, and IP Address, and an 'Add' button. Below this section are 'Save & Apply' and 'Save' buttons.

Note:

- Hostname is empty means IP and MAC binding.
- MAC is empty means hostname and IP binding.
- To set all means to bind a MAC to an IP and set the hostname for this MAC.
- IP address must be in the same network segment with the LAN IP address of USR-G809.

4.3. Hostnames

USR-G809 supports custom domain name resolution. Set the hostname and IP address in below interface, to achieve the mapping between hostname and IP address.

The outside IP address can also be mapped(must be a unique public IP address). The hostname of DHCP and static IP cannot be a number. After setting all parameters, restart the device to take the parameters effect.

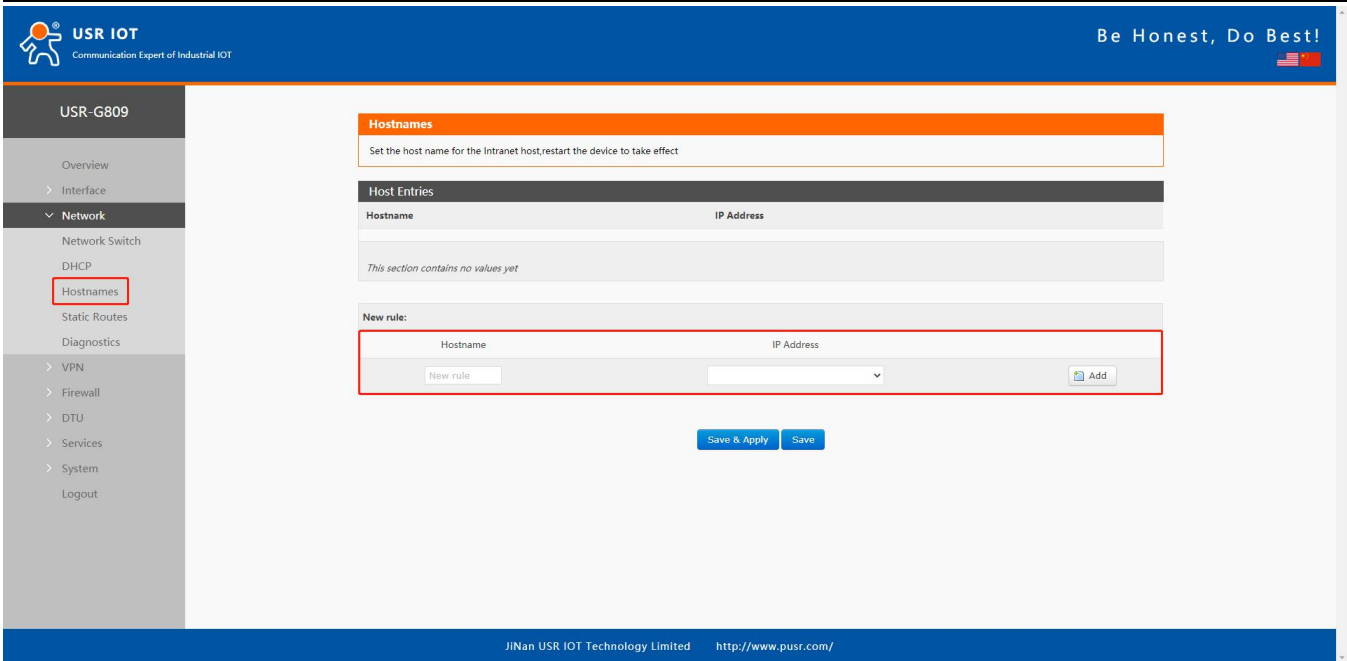

The screenshot shows the 'Hostnames' configuration page in the USR-G809 web interface. The sidebar on the left lists various network settings, with 'Hostnames' selected. The main content area features a 'Hostnames' section with a text input field for setting the host name. Below this is a 'Host Entries' table, which is currently empty. At the bottom, there is a 'New rule' section with input fields for 'Hostname' and 'IP Address', and buttons for 'Add', 'Save & Apply', and 'Save'.

4.4. Static Routes

USR-G809 supports up to 20 static route rules.

Item	Description	Default
Interface	Lan, wan_4G, wan_wired, vpn	lan
Target	Destination IP address or IP range	Null
Netmask	Netmask of the destination network	Null
Gateway	The IP address to forward to	Null
Metric	Used to make routing decisions	Null

Test example:

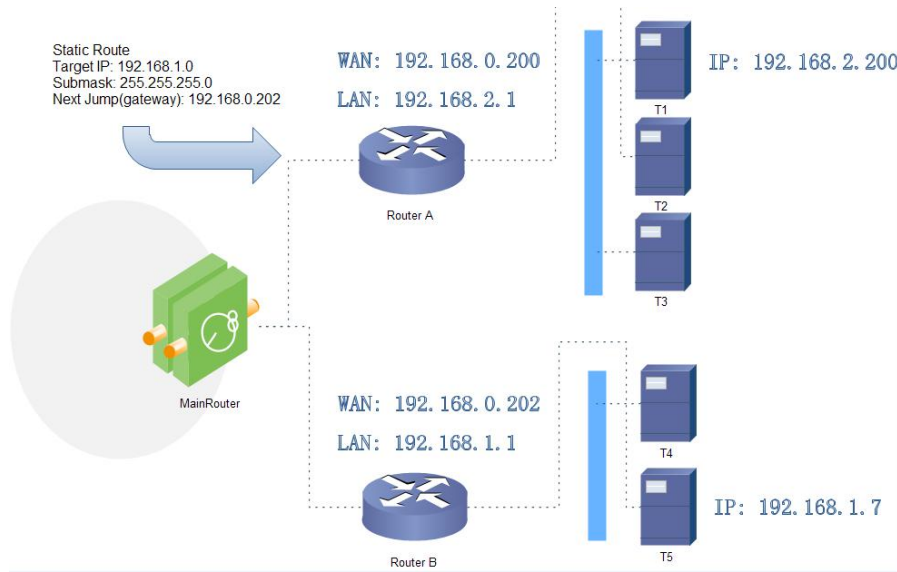

The WAN port of router A and router B are connected to the network 192.168.0.0, LAN network of router A is 192.168.2.0, LAN network of router B is 192.168.1.0.

Now we can do a static route in router A, when we access the 192.168.1.X, will automatically forward to router B.

Static Routing

To find information on static routing configuration, refer to the figure and table below

Static Routing | Routing Table

Static IPv4 Routes

Interface	Target	IPv4-Netmask	IPv4-Gateway	Metric
This section contains no values yet				

New Rule:

Interface	Target	IPv4-Netmask	IPv4-Gateway	Metric
wan_wired	192.168.1.0	255.255.255.0	192.168.0.202	0

Save & Apply | Save

In router B:

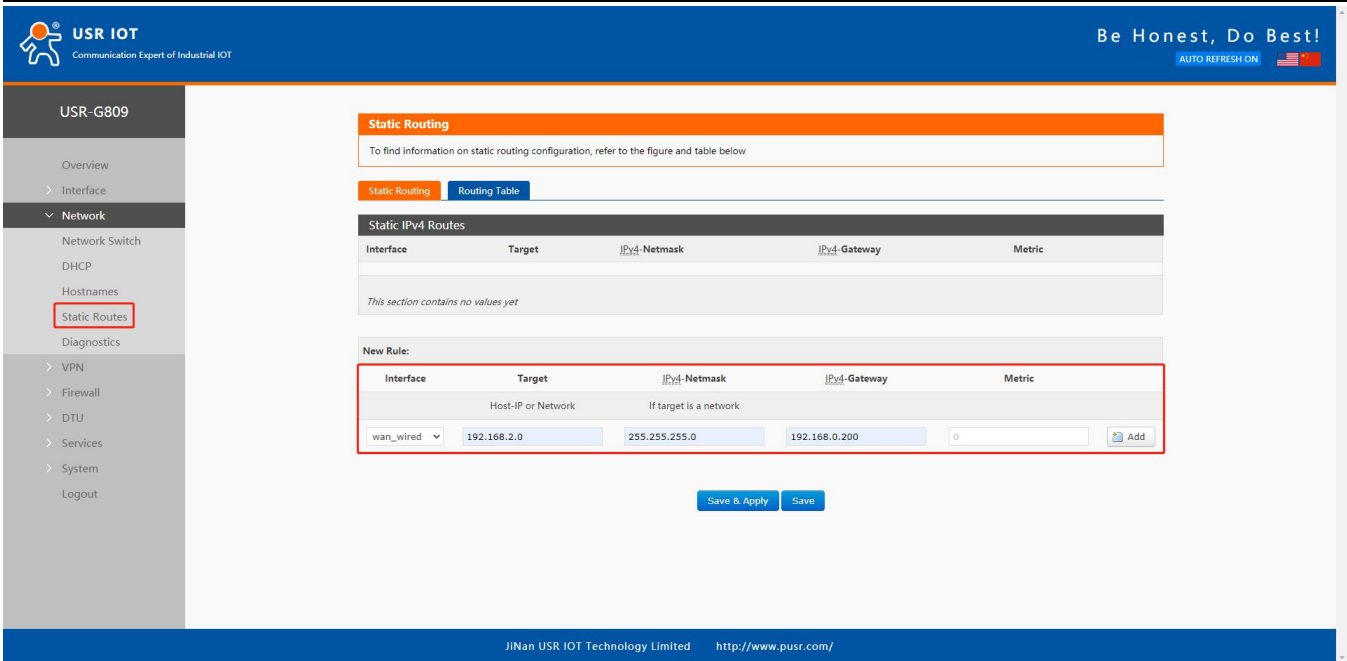

After setting all parameters, restart the device.

Ping from T1 to T5:

```
以太网适配器 以太网:
    连接特定的 DNS 后缀 . . . . . : lan
    本地链接 IPv6 地址. . . . . : fe80::50c0:bela:24a0:cb78%25
    IPv4 地址 . . . . . : 192.168.2.200
    子网掩码 . . . . . : 255.255.255.0
    默认网关. . . . . : 192.168.2.1

无线局域网适配器 WLAN:
    媒体状态 . . . . . : 媒体已断开连接
    连接特定的 DNS 后缀 . . . . . : lan

C:\Users\Administrator>ping 192.168.1.7
正在 Ping 192.168.1.7 具有 32 字节的数据:
来自 192.168.1.7 的回复: 字节=32 时间=2ms TTL=253
来自 192.168.1.7 的回复: 字节=32 时间=1ms TTL=253
来自 192.168.1.7 的回复: 字节=32 时间=1ms TTL=253
来自 192.168.1.7 的回复: 字节=32 时间=1ms TTL=253

192.168.1.7 的 Ping 统计信息:
    数据包: 已发送 = 4, 已接收 = 4, 丢失 = 0 (0% 丢失),
    往返行程的估计时间(以毫秒为单位):
        最短 = 1ms, 最长 = 2ms, 平均 = 1ms
```

4.5. Diagnostics

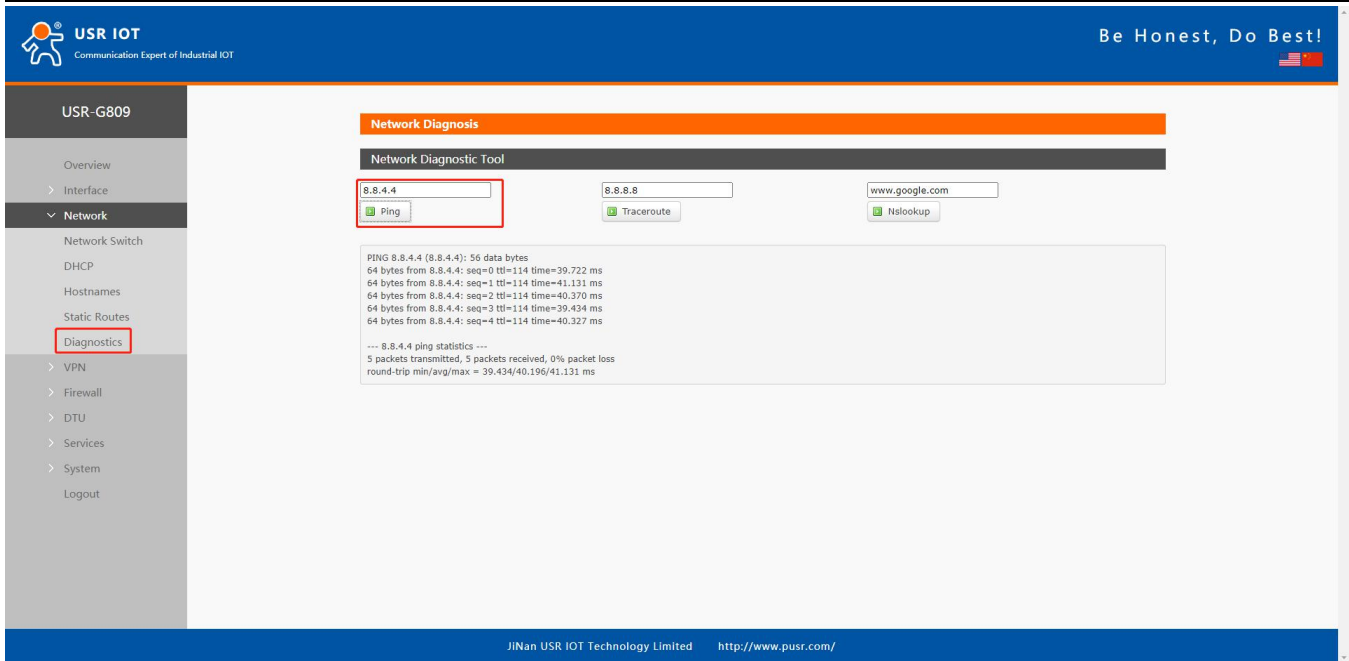

The screenshot displays the 'Network Diagnostic Tool' interface. It features three input fields for testing: '8.8.4.4' (with a 'Ping' button), '8.8.8.8' (with a 'Traceroute' button), and 'www.google.com' (with an 'Nslookup' button). The 'Ping' tool is selected, showing the following output:

```

PING 8.8.4.4 (8.8.4.4): 56 data bytes
64 bytes from 8.8.4.4: seq=0 ttl=114 time=39.722 ms
64 bytes from 8.8.4.4: seq=1 ttl=114 time=41.131 ms
64 bytes from 8.8.4.4: seq=2 ttl=114 time=40.370 ms
64 bytes from 8.8.4.4: seq=3 ttl=114 time=39.434 ms
64 bytes from 8.8.4.4: seq=4 ttl=114 time=40.327 ms

--- 8.8.4.4 ping statistics ---
5 packets transmitted, 5 packets received, 0% packet loss
round-trip min/avg/max = 39.434/40.196/41.131 ms
    
```

This interface provides users three tools: Ping, Traceroute and Nslookup.

- Ping: Ping a destination address to check the network status.
- Traceroute: Send traceroute request to a destination address.
- Nslookup: Resolve the domain name to an IP address.

5. VPN

USR-G809 supports PPTP, L2TP, IPSEC, openVPN and GRE.

No.	Protocol	Version
1	PPTP	V1.10.0
2	L2TP	V1.3.15
3	IPSec	V5.3.3
4	OpenVPN	V2.3.18

5.1. PPTP Client

This interface allows users to set the PPTP server parameters.

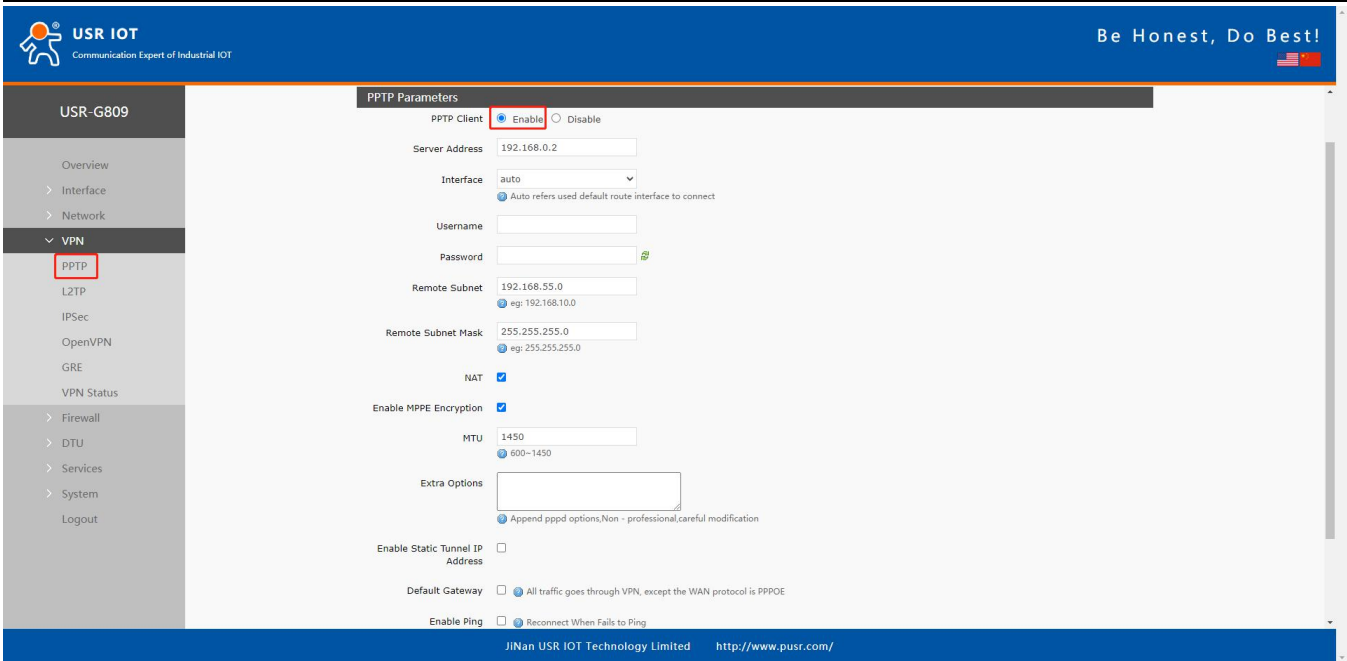

Item	Description	Default
Server address	VPN server address or domain name	192.168.0.2
Interface	wan_4G, wan_wired or auto	auto
Username/Password	Get from the VPN server	Null
Encryption	MPPE or no encryption	MPPE
MTU	Consistent with the VPN server	1500
NAT	The source IP address of host behind G809 will be disguised before accessing the remote address.	Enable
Remote Subnet/Mask	When NAT is enabled, can achieve the subnet communication under VPN.	192.168.55.0/255.255.255.0
Enable Static Tunnel IP Address	When it is disabled, VPN server will assign an IP address dynamically.	Disable
Extra Options	Append pppd parameters, magic number.	Null
Enable ping	Real-time VPN online detection and reconnection mechanism.	Disable

After connecting to PPTP server, we can check the connection status in “VPN Status”.

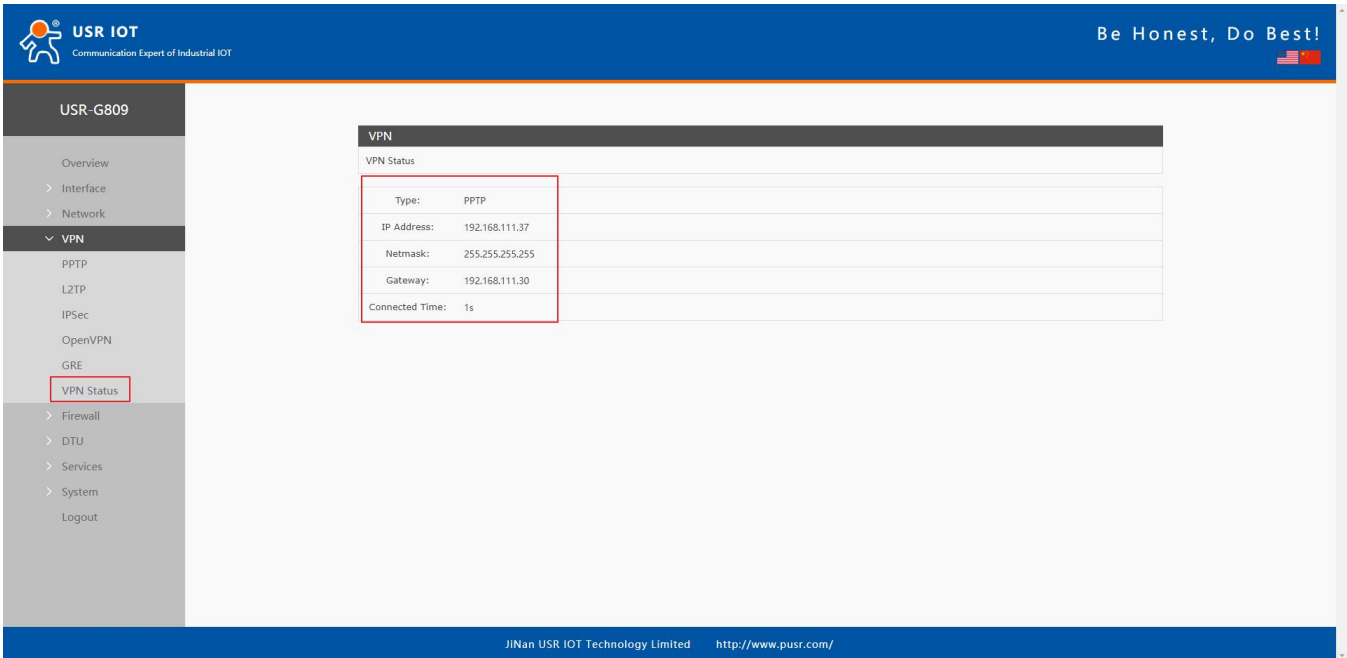

VPN	
VPN Status	
Type:	PPTP
IP Address:	192.168.111.37
Netmask:	255.255.255.255
Gateway:	192.168.111.30
Connected Time:	1s

5.2. L2TP Client

L2TP is the layer 2 tunneling protocol which similar to PPTP. G809 supports tunnel password authentication, supports MPPE and L2TP over IPSEC encryption.

In “VPN---L2TP”, enable L2TP Client, set the related parameters.

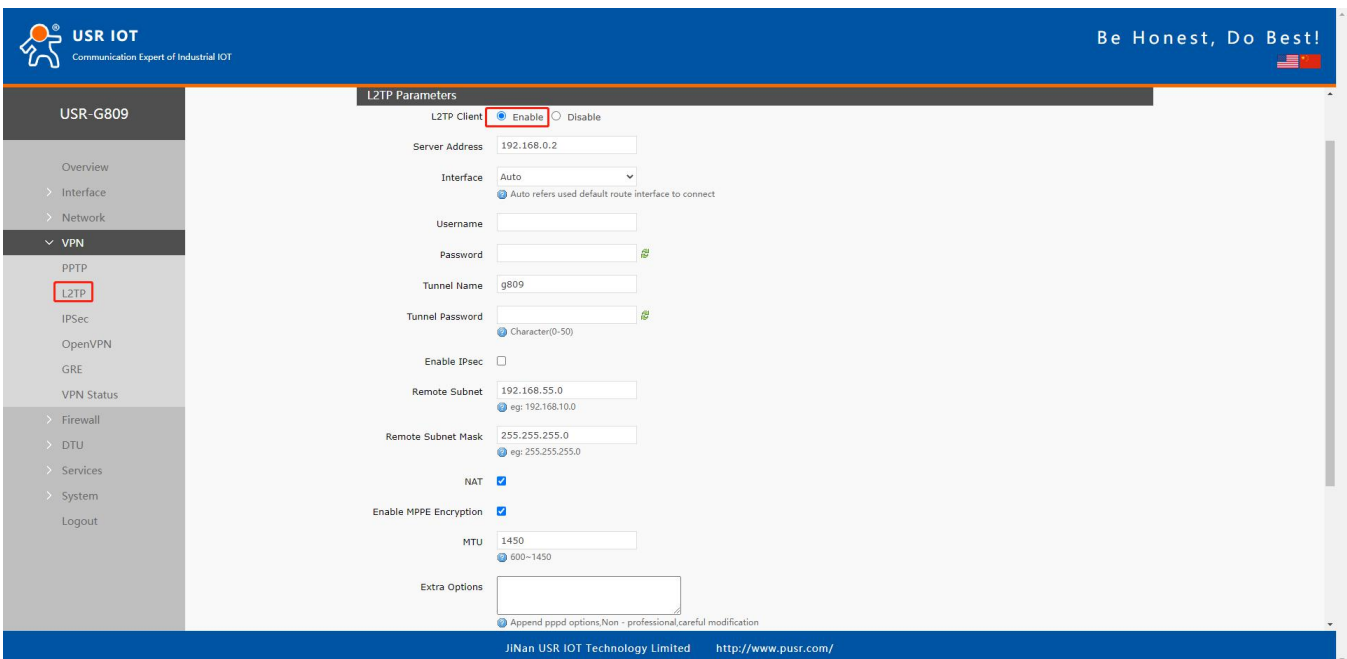

L2TP Parameters

L2TP Client: Enable Disable

Server Address:

Interface: (Auto refers used default route interface to connect)

Username:

Password:

Tunnel Name:

Tunnel Password: (Character(0-50))

Enable IPsec:

Remote Subnet: (eg: 192.168.10.0)

Remote Subnet Mask: (eg: 255.255.255.0)

NAT:

Enable MPPE Encryption:

MTU: (600-1450)

Extra Options:

Append pppd options, Non - professional careful modification

Item	Description	Default
Server address	VPN server address or domain name	192.168.0.2
Interface	wan_4G, wan_wired or auto	auto
Username/Password	Get from the VPN server	Null
Encryption/Authentication	Tunnel password, MPPE, IPSEC, consistent with the VPN server.	MPPE
Enable Static Tunnel IP Address	When it is disabled, VPN server will assign an IP address dynamically.	Disable
Extra Options	Append pppd parameters, magic number.	Null
NAT	The source IP address of host behind G809 will be disguised before accessing the remote address.	Enable
Remote Subnet/Mask	When NAT is enabled, can achieve the subnet communication under VPN.	192.168.55.0/255.255.255.0
Enable ping	Real-time VPN online detection and reconnection mechanism.	Disable

After connecting to L2TP server, we can check the connection status in “VPN Status”.

5.3. IPSec

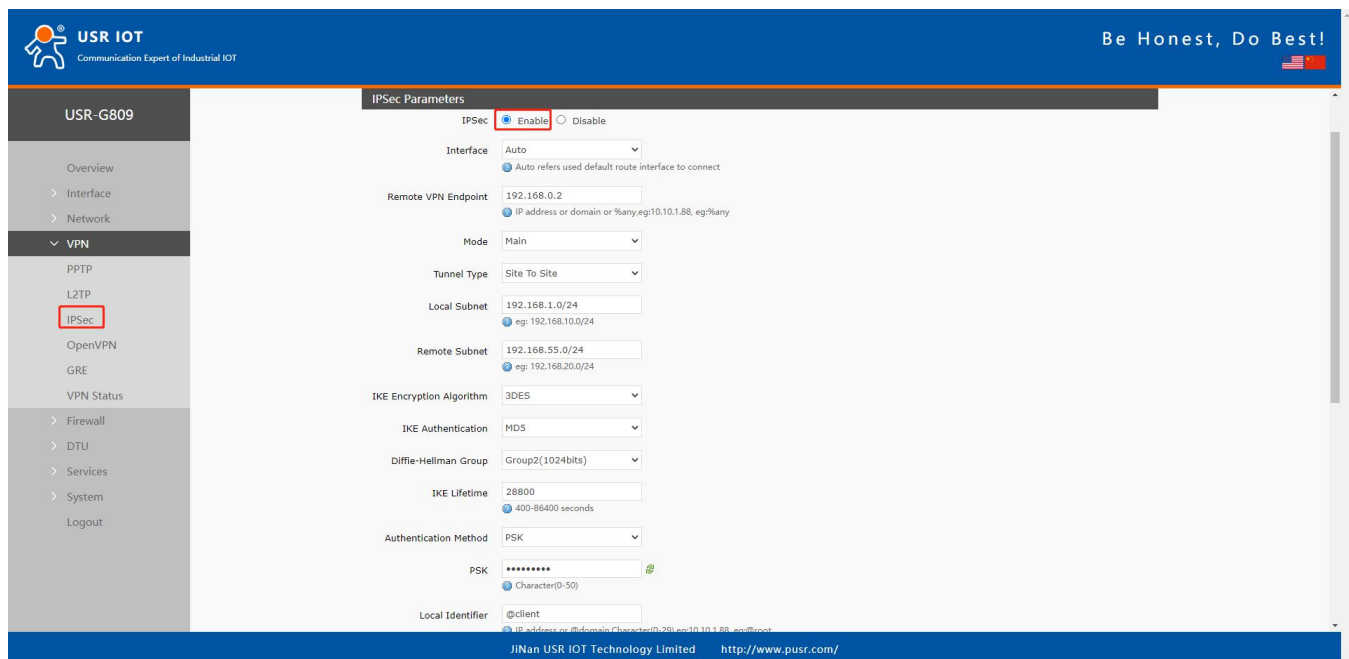

The screenshot shows the 'IPSec Parameters' configuration page in the USR-G809 web interface. The 'IPSec' checkbox is checked and highlighted with a red box. The configuration includes the following details:

- IPSec:** Enable Disable
- Interface:** Auto
- Remote VPN Endpoint:** 192.168.0.2
- Mode:** Main
- Tunnel Type:** Site To Site
- Local Subnet:** 192.168.1.0/24
- Remote Subnet:** 192.168.55.0/24
- IKE Encryption Algorithm:** 3DES
- IKE Authentication:** MD5
- Diffie-Hellman Group:** Group2(1024bits)
- IKE Lifetime:** 28800
- Authentication Method:** PSK
- Local Identifier:** @client

Descriptions:

Item	Description	Default
Interface	wan_4G, wan_wired or auto	auto
Remote VPN Endpoint	VPN Client/Server, remote endpoint IP/domain	192.168.0.2
Mode	Main, aggressive	main
Tunnel type	Site to site, site to host, host to host, host to site	Site to site
Local subnet	IPSec local subnet and mask	192.168.1.0/24
Remote subnet	IPSec remote subnet and mask	192.168.55.0/24
Local Identifier	IP address or FQDN preceded by @, e.g. @domain	@client
Peer Identifier	IP address or FQDN preceded by @, e.g. @domain	@server
IKE Encryption	Phase 1 IKE encryption algorithm, authentication and DH group settings.	3DES/MD5/Group2
IKE Lifetime	Set the lifetime in IKE negotiation, 400~86400s	28800
Authentication Method	Pre-shared key	PSK
ESP encryption	3DES/AES-128/AES-192/AES-256	AES-128
ESP Authentication	SHA-1/SHA2-256/MD5	SHA-1
ESP Lifetime	Set the ESP lifetime/s	3600
PFS Group	None/DH1/DH2/DH5	DH2
DPD Interval	Set the interval after which DPD is triggered if no IPsec protected packets is received from the peer/s	60
DPD Timeout	Set the timeout of DPD packets/s	60
DPD Action	Sets the action for connection detection, None/Clear/Hold/Restart	Restart

After connected successfully, we can check the connection status in "VPN - VPN Status".

5.4. OpenVPN

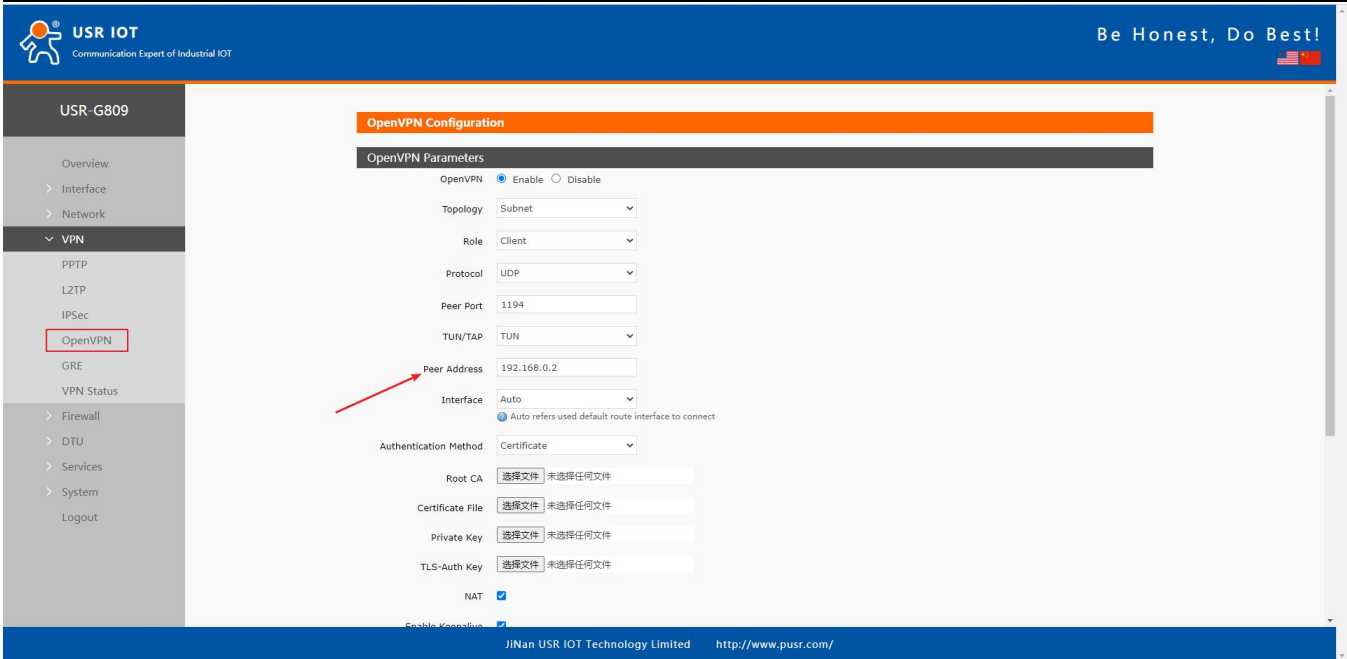

Item	Description	Default
TUN/TAP	TUN/TAP	TUN
Protocol	TCP/UDP	UDP
Peer Port	Listening port of the OpenVPN server	1194
Peer Address	IP/domain name of the OpenVPN server	192.168.0.2
Interface	Auto/wan_wired/wan_4g	Auto
Root CA	Import the ca root file to the router	Null
Certificate File	Import the client certificate file to the router	Null
Private Key	Import the client private key to the router	Null
TLS-Auth Key	Import the TLS authentication key to the router	Null
Encrypt Algorithm	None/Blowfish-128/DES-128/3DES-192/AES-128/AES-192/AES-256	Blowfish-128
Hash Algorithm	None/SHA1/SHA256/SHA512/MD5	None
Enable LZO	Yes/No/Adaptive	Adaptive
Enable Keepalive	Defaults to 10,120, consistent with VPN server	On
MTU	Consistent with VPN server	1500
Enable Ping	Reconnect when fails to ping	Off

After connected successfully, we can check the connection status in “VPN - VPN Status”.

Attached: OpenVPN server configuration under Linux:

```

port 1194
proto udp
dev tun
user nobody
group nogroup
persist-key
persist-tun
keepalive 10 120
topology subnet
server 10.8.0.0 255.255.255.0
ifconfig-pool-persist ipp.txt
push "dhcp-option DNS 8.8.8.8"
push "dhcp-option DNS 8.8.4.4"
push "redirect-gateway def1 bypass-dhcp"
crl-verify crl.pem
ca ca.crt
cert server_Jz40qi4AWJnZuN8X.crt
key server_Jz40qi4AWJnZuN8X.key
tls-auth tls-auth.key 0
dh dh.pem
auth SHA256
cipher AES-256-CBC
#tls-server
#tls-version-min 1.2
#tls-cipher TLS-DHE-RSA-WITH-AES-128-GCM-SHA256
status openvpn.log
verb 3
    
```

5.5. GRE

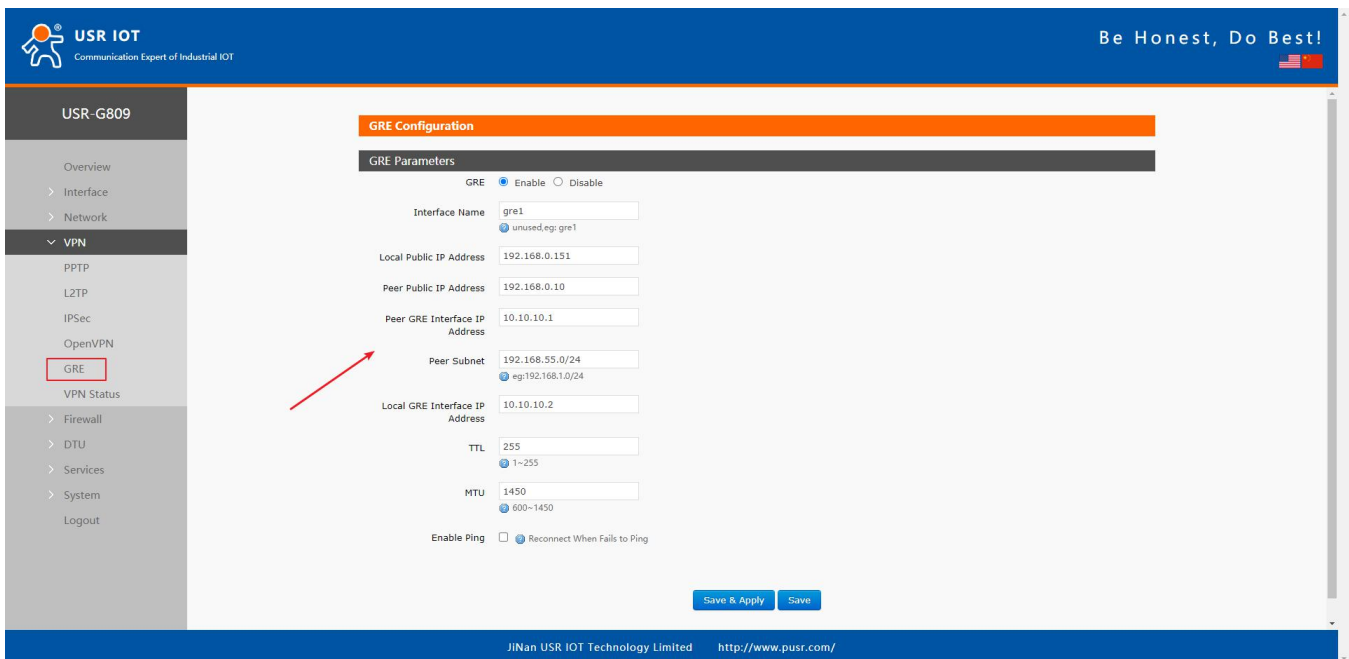

Item	Description	Default
Local public IP address	Local wan_wired or wan_4g address	192.168.0.151
Peer public IP address	Remote GRE WAN IP address	192.168.0.10
Peer GRE Interface IP Address	Remote GRE tunnel IP address	10.10.10.1

Peer Subnet	IP/Mask: 255.255.255.0: IP/24 255.255.255.255: IP/32	192.168.55.0/24
Local GRE Interface IP Address	Local GRE tunnel IP address	10.10.10.2
TTL	Set the TTL parameters(1~255)	255
MTU	Set the MTU(600~1450)	1450

6. Firewall

6.1. General Settings

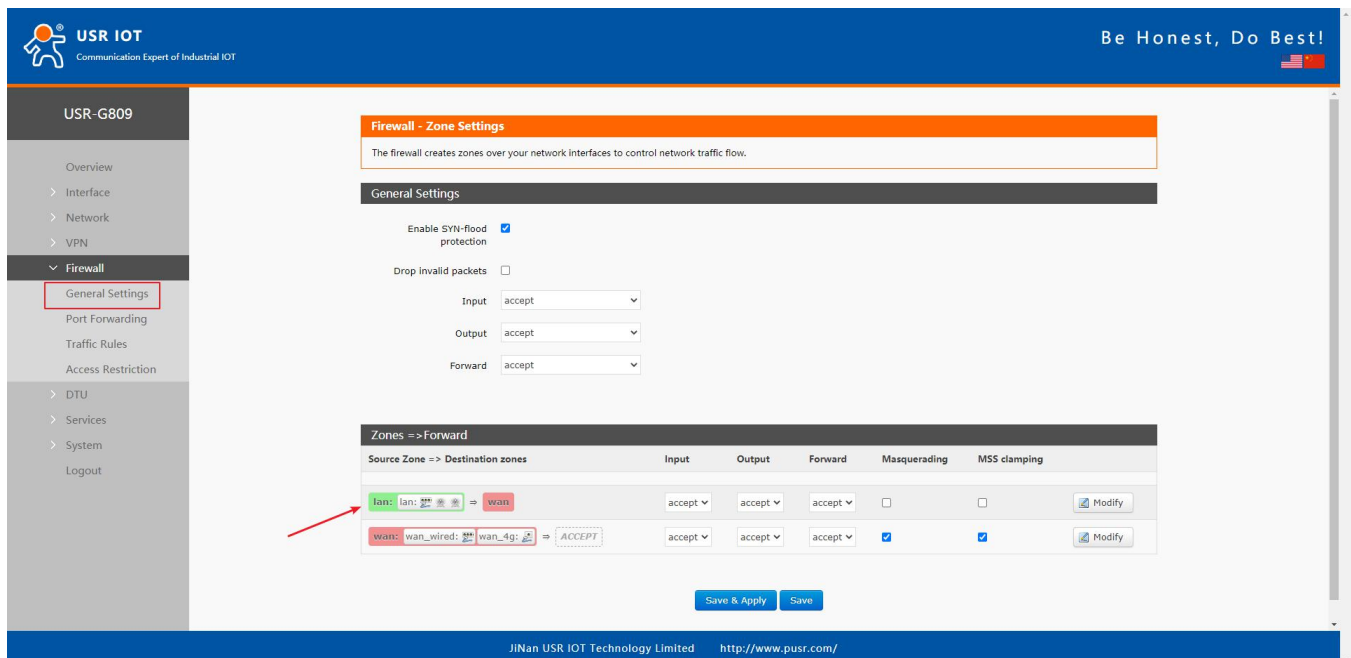

Descriptions:

1. Input: Data packets access to the router's IP.
2. Output: Data packets sent by the router's IP.
3. Forward: Data forwarding between the interfaces, not go through the router.
4. Masquerading: WAN and 4G interface. The source IP address will be disguised before accessing the external network.
5. MSS clamping: Limit the MSS packets, generally is 1460.

6.2. NAT

6.2.1. Masquerading

Masquerading will disguise the source IP address of the data packets to the WAN IP address of the router.

The masquerading and MSS clamping of the WAN interface must be enabled, which must be disabled in the LAN interface.

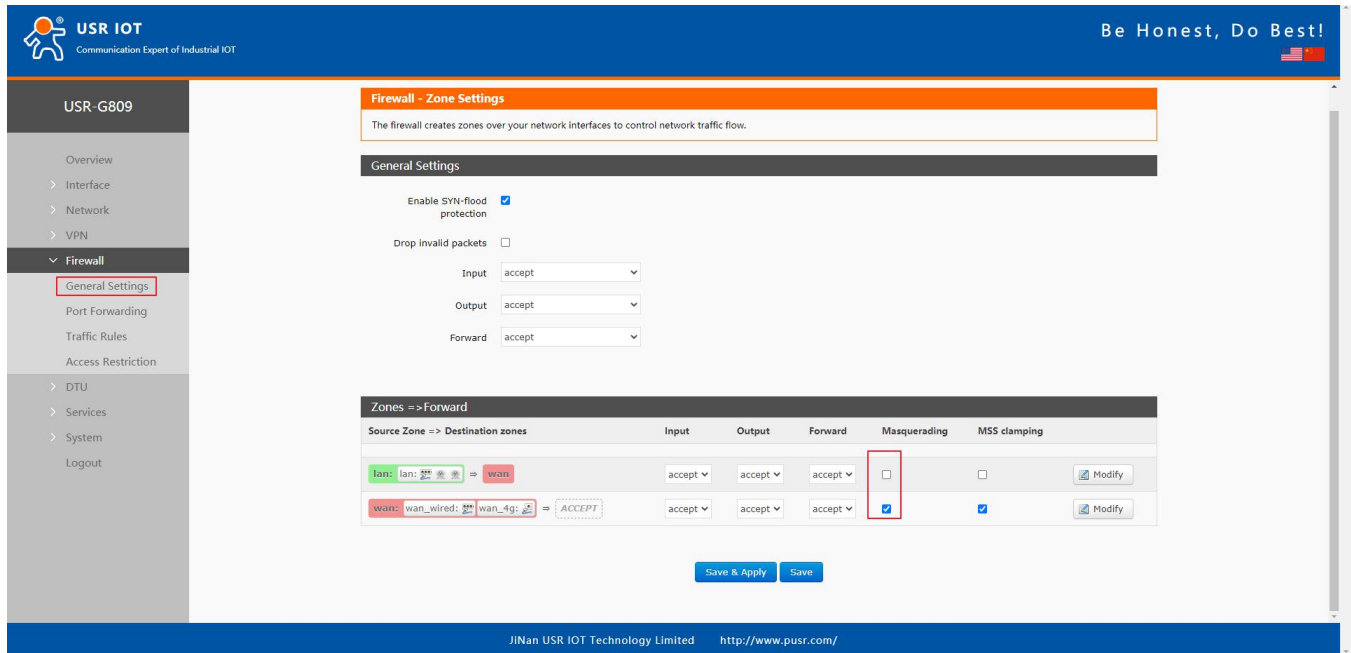

The screenshot shows the 'Firewall - Zone Settings' page in the USR IOT web interface. The left sidebar shows the navigation menu with 'Firewall' expanded and 'General Settings' selected. The main content area has a title 'Firewall - Zone Settings' and a description: 'The firewall creates zones over your network interfaces to control network traffic flow.' Below this is the 'General Settings' section with the following options:

- Enable SYN-flood protection:
- Drop invalid packets:
- Input: accept
- Output: accept
- Forward: accept

The 'Zones => Forward' section contains a table with the following data:

Source Zone => Destination zones	Input	Output	Forward	Masquerading	MSS clamping	
lan: lan => wan	accept	accept	accept	<input type="checkbox"/>	<input type="checkbox"/>	Modify
wan: wan_wired: wan_4g: => ACCEPT	accept	accept	accept	<input checked="" type="checkbox"/>	<input checked="" type="checkbox"/>	Modify

At the bottom of the page, there are 'Save & Apply' and 'Save' buttons.

6.2.2. Port Forwarding

Port forwarding rules can map a specific port of the WAN interface to a intranet host.

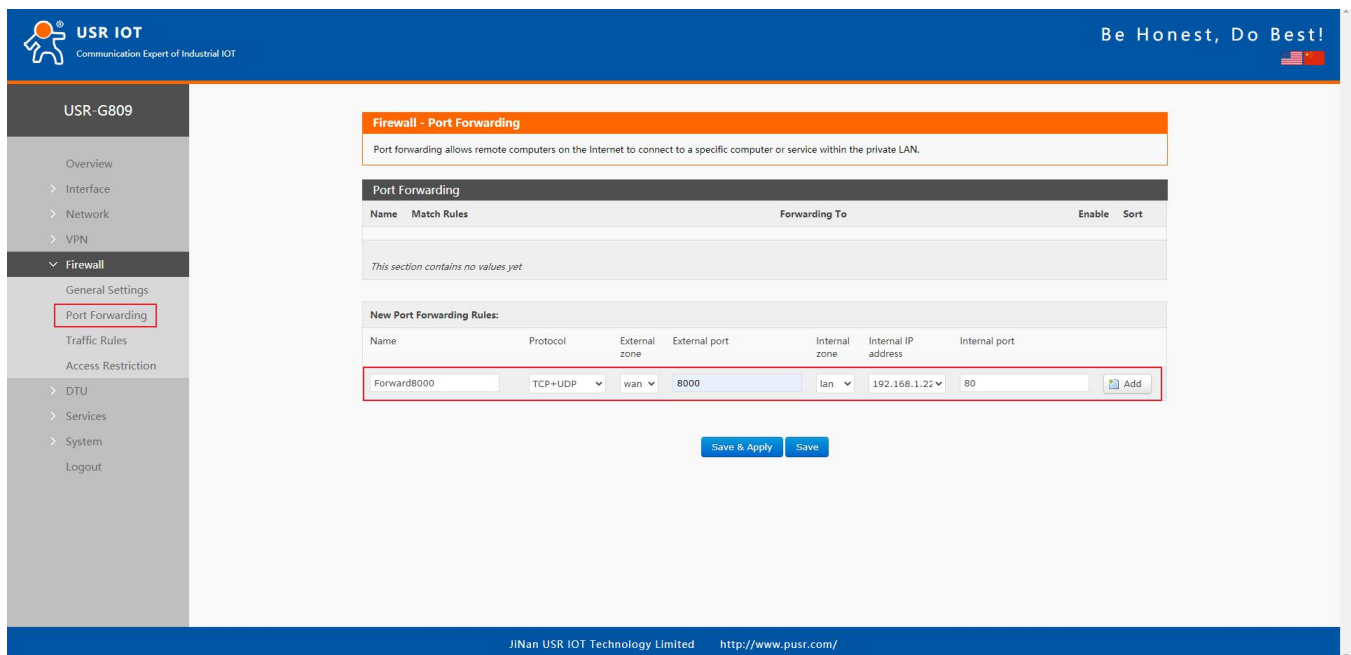

The screenshot shows the 'Firewall - Port Forwarding' page in the USR IOT web interface. The left sidebar shows the navigation menu with 'Firewall' expanded and 'Port Forwarding' selected. The main content area has a title 'Firewall - Port Forwarding' and a description: 'Port forwarding allows remote computers on the Internet to connect to a specific computer or service within the private LAN.' Below this is the 'Port Forwarding' section with a table showing no existing rules:

Name	Match Rules	Forwarding To	Enable	Sort
This section contains no values yet				

The 'New Port Forwarding Rules:' section contains a table with the following data:

Name	Protocol	External zone	External port	Internal zone	Internal IP address	Internal port	
Forward8000	TCP+UDP	wan	8000	lan	192.168.1.22	80	Add

At the bottom of the page, there are 'Save & Apply' and 'Save' buttons.

Click "Save&Apply".

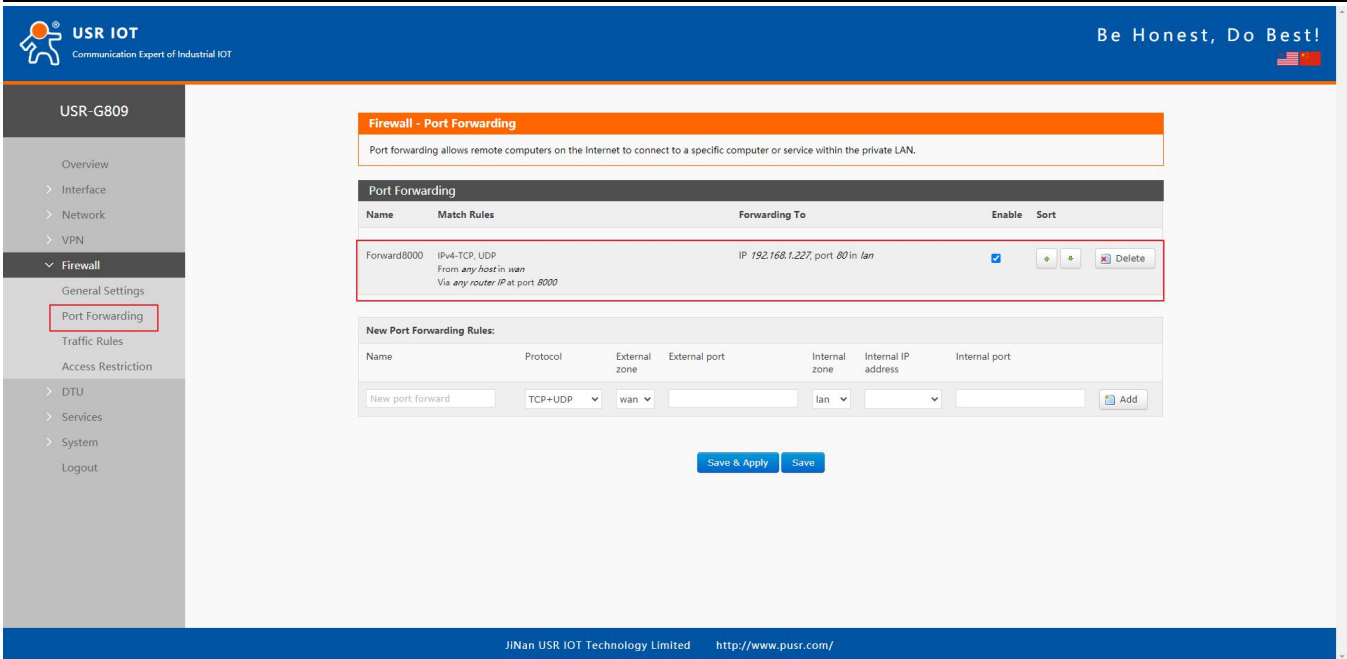

When we access the port 8000 of the WAN interface, it will be forwarded to 192.168.1.227, port 80.

- Note: Users can also set the port number range in port forwarding interface(E.g: 8888-9999), the external port number range must be same with the internal port number range.

6.2.3. DMZ

Port forwarding rules map a specified WAN port to a intranet host, DMZ rules will map all ports of the WAN interface to a intranet host.

DMZ rules are set in the port forwarding interface, in DMZ mode, do not need to set the external port and internal port.

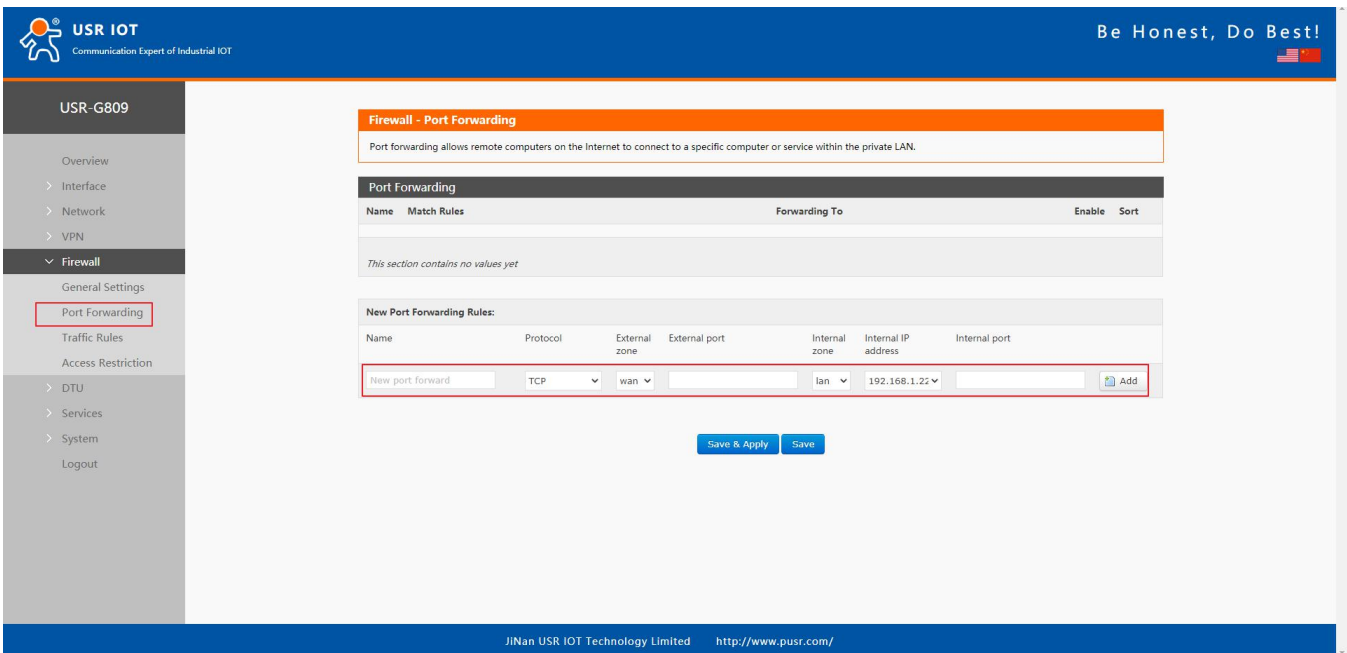

Click “Save&Apply”.

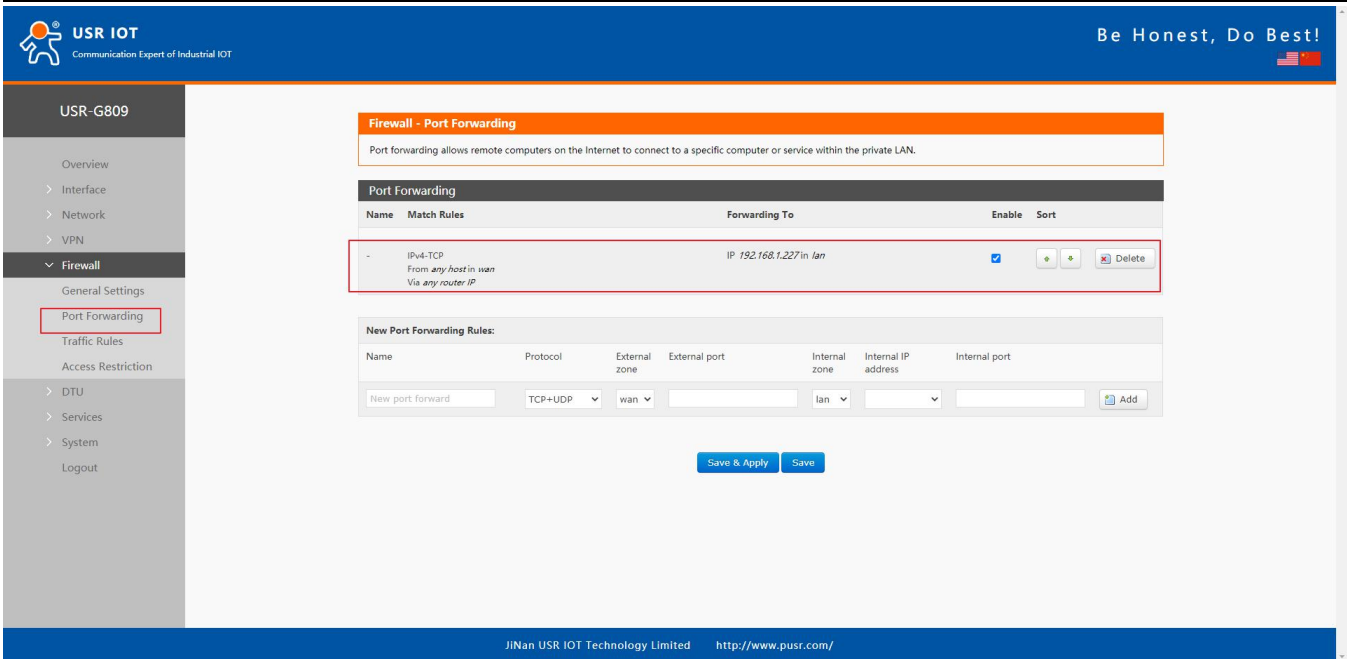

The screenshot shows the 'Firewall - Port Forwarding' configuration page. The left sidebar has 'Port Forwarding' highlighted. The main content area includes a description of port forwarding, a table of existing rules, and a form for adding new rules. A red box highlights the existing rule for IPv4-TCP forwarding to 192.168.1.227. Another red box highlights the 'New forward rule' form fields: Name, Source zone (lan), and Destination zone (wan).

Name	Match Rules	Forwarding To	Enable	Sort
-	IPv4-TCP From any host in wan Via any router IP	IP 192.168.1.227 in lan	<input checked="" type="checkbox"/>	+ + - X Delete

Name	Protocol	External zone	External port	Internal zone	Internal IP address	Internal port
New port forward	TCP+UDP	wan		lan		

All the ports of the WAN address will be forwarded to the intranet host 192.168.1.227.

➤ Note: Port forwarding and DMZ cannot be used at the same time.

6.3. Traffic Rules

Traffic rules can filter specific internet data types and block internet access requests to enhance the security of the network.

6.3.1. IP Address Blacklist

In "New forward rule", enter the name then click "Add and edit".

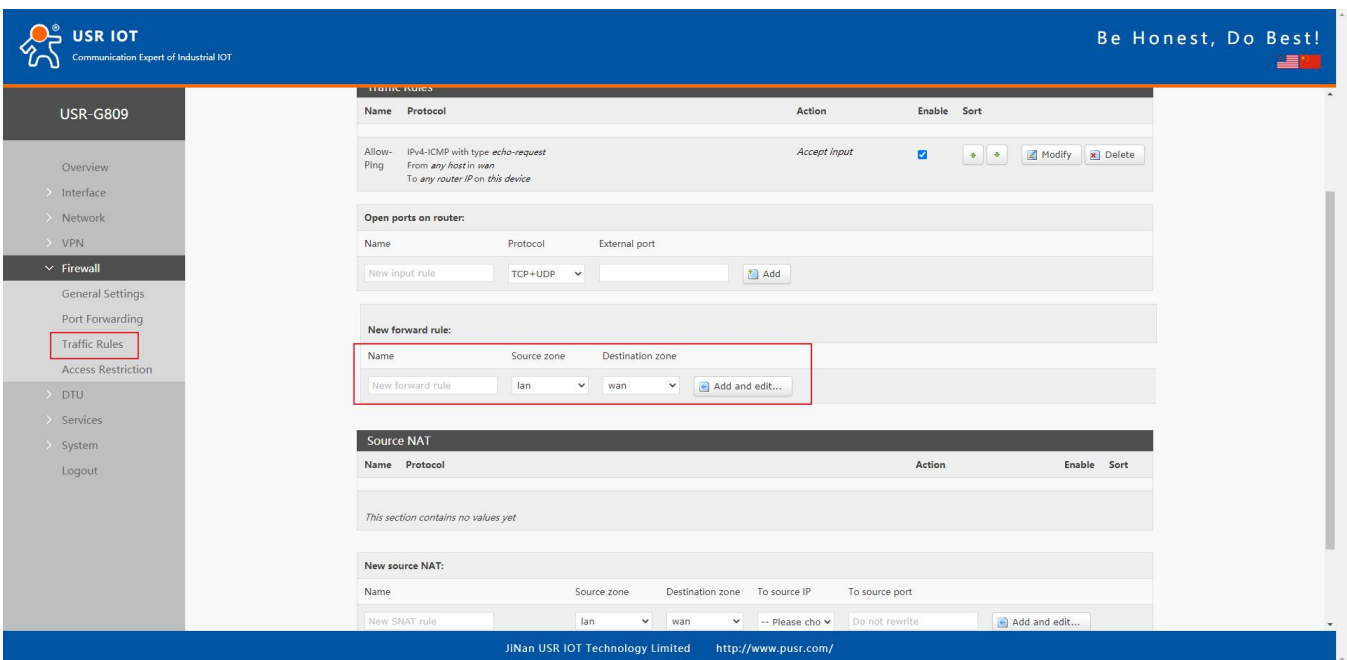

The screenshot shows the 'Traffic Rules' configuration page. The left sidebar has 'Traffic Rules' highlighted. The main content area includes a table of existing rules, a form for adding new rules, and a section for Source NAT. A red box highlights the 'New forward rule' form fields: Name, Source zone (lan), and Destination zone (wan).

Name	Protocol	Action	Enable	Sort
Allow-Ping	IPv4-ICMP with type echo-request From any host in wan To any router IP on this device	Accept input	<input checked="" type="checkbox"/>	+ + - X Modify Delete

Name	Source zone	Destination zone
New forward rule	lan	wan

In below interface, set the “Source zone” to “lan”, “Source MAC address” and “Source IP address” are “any”(There are two methods to limit a specific LAN IP address to access a specific external IP address: fill in the IP address or MAC address, the other one is any; or the IP address corresponds to the MAC address.)

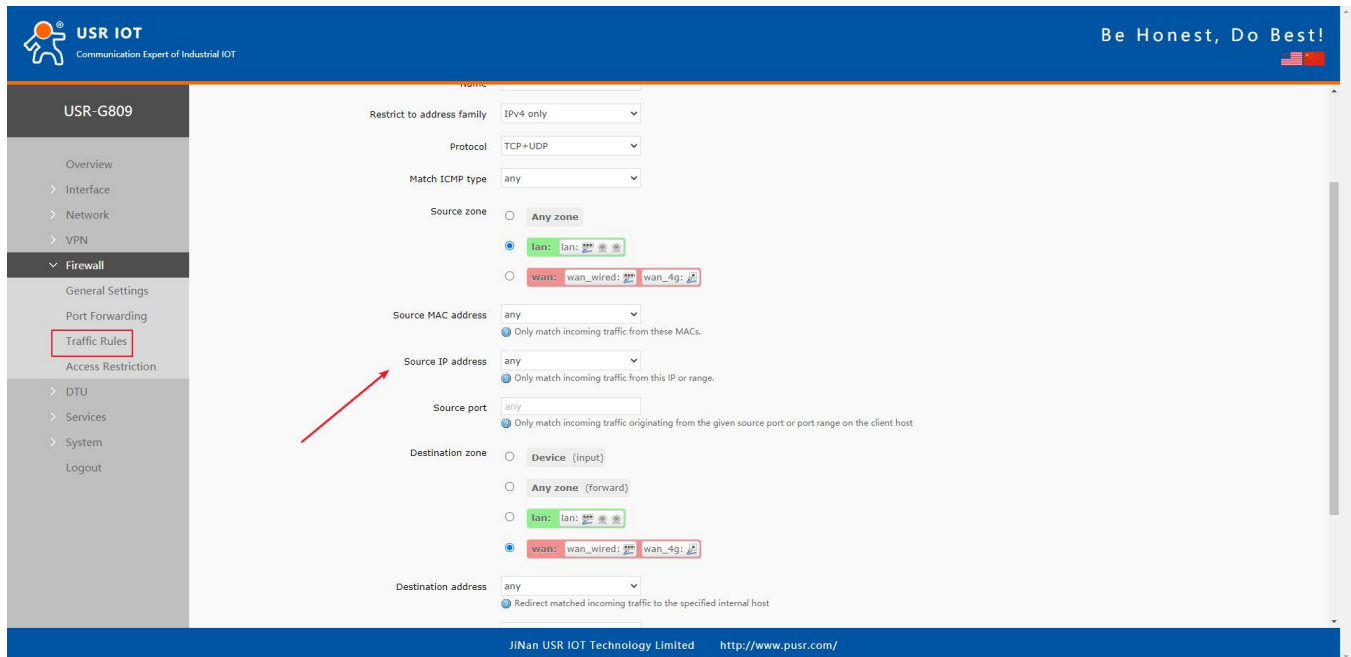

Set the “Destination zone” to “wan”, “Destination address” is the IP address that restricted to be accessed. Set the “Action” to “reject”, click “Save&apply”.

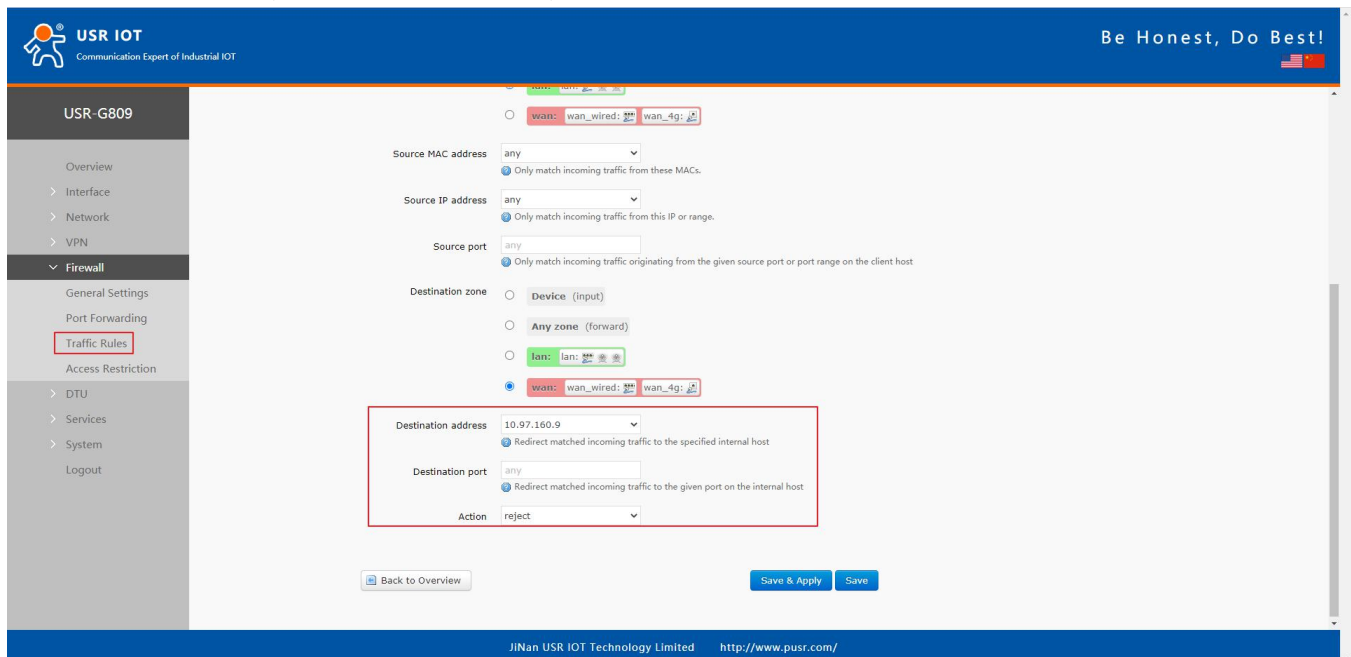

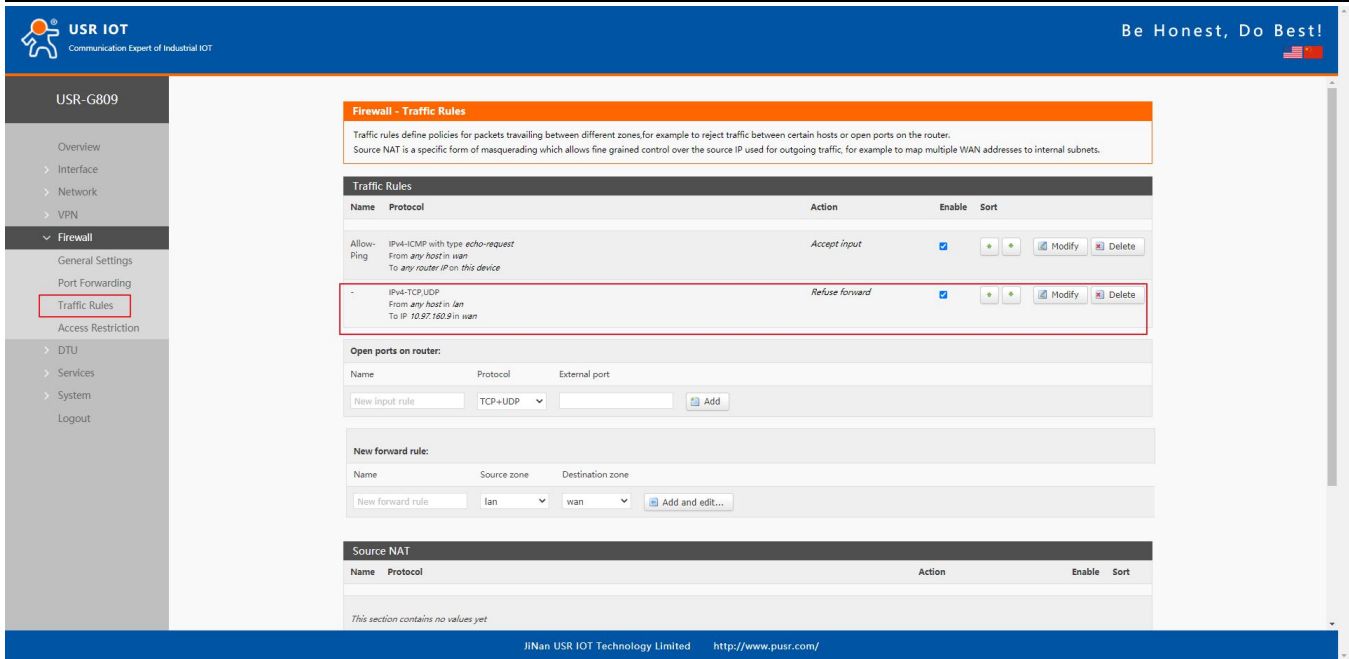

Firewall - Traffic Rules

Traffic rules define policies for packets travelling between different zones, for example to reject traffic between certain hosts or open ports on the router. Source NAT is a specific form of masquerading which allows fine grained control over the source IP used for outgoing traffic, for example to map multiple WAN addresses to internal subnets.

Name	Protocol	Action	Enable	Sort
Allow-Ping	IPv4-ICMP with type: echo-request From any host in wan To any router IP on this device	Accept input	<input checked="" type="checkbox"/>	+
-	IPv4-TCP,UDP From any host in lan To IP 10.97.160.9 in wan	Refuse forward	<input checked="" type="checkbox"/>	+

Open ports on router:

Name	Protocol	External port
New input rule	TCP+UDP	

New forward rule:

Name	Source zone	Destination zone
New forward rule	lan	wan

Source NAT

Name	Protocol	Action	Enable	Sort
This section contains no values yet				

JiNan USR IOT Technology Limited <http://www.pusr.com/>

6.3.2. IP Address Whitelist

Enter the rule's name, click "Add and edit" to create a whitelist.

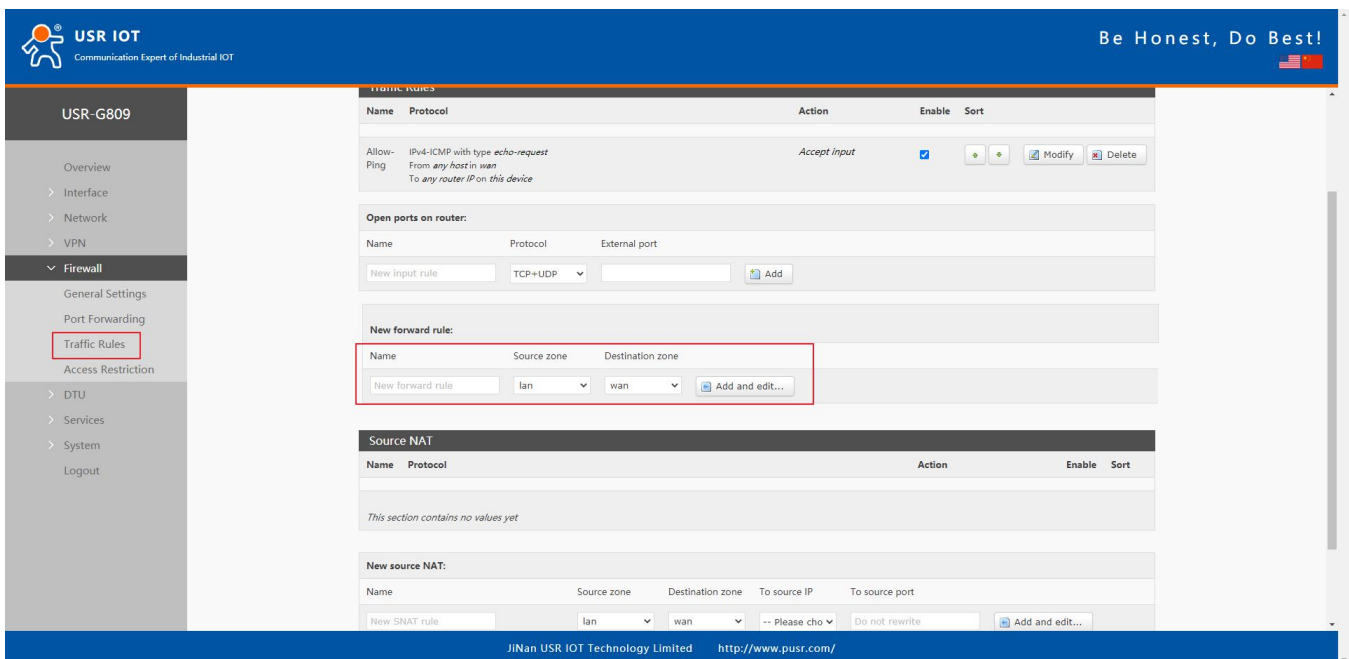

Firewall - Traffic Rules

Name	Protocol	Action	Enable	Sort
Allow-Ping	IPv4-ICMP with type: echo-request From any host in wan To any router IP on this device	Accept input	<input checked="" type="checkbox"/>	+

Open ports on router:

Name	Protocol	External port
New input rule	TCP+UDP	

New forward rule:

Name	Source zone	Destination zone
New forward rule	lan	wan

Source NAT

Name	Protocol	Action	Enable	Sort
This section contains no values yet				

New source NAT:

Name	Source zone	Destination zone	To source IP	To source port
New SNAT rule	lan	wan	-- Please cho	Do not rewrite

JiNan USR IOT Technology Limited <http://www.pusr.com/>

In below interface, set the "Source zone" to "lan", "Source MAC address" and "Source IP address" are "any"(There are two methods to limit a specific LAN IP address to access a specific external IP address: fill in the IP address or MAC address, the other one is any; or the IP address corresponds to the MAC address.)

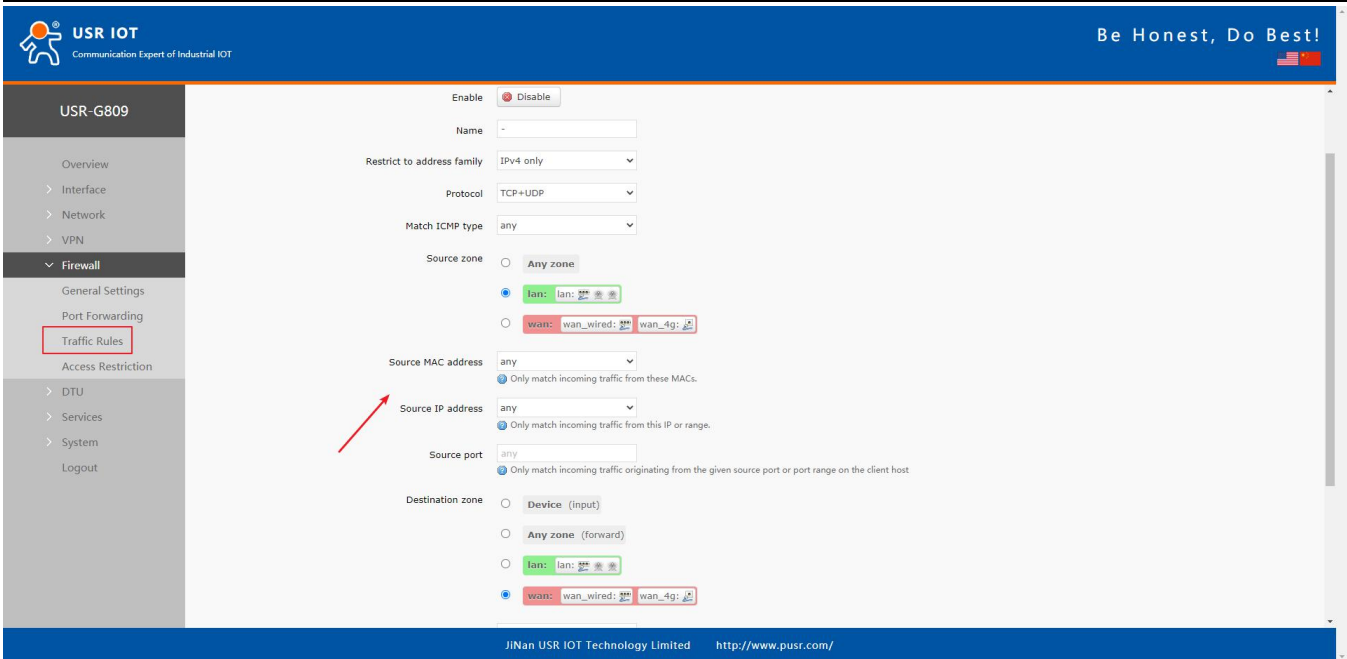

The screenshot shows the 'Traffic Rules' configuration page in the USR IOT web interface. The 'Destination zone' is set to 'wan'. A red arrow points to the 'Source IP address' field, which is currently set to 'any'. Other fields include 'Name', 'Restrict to address family' (IPv4 only), 'Protocol' (TCP+UDP), 'Match ICMP type' (any), 'Source zone' (lan), 'Source MAC address' (any), 'Source port' (any), and 'Destination zone' (wan).

Set the “Destination zone” to “wan”, “Destination address” is the IP address that allowed to be accessed. Set the “Action” to “accept”, click “Save&apply”.

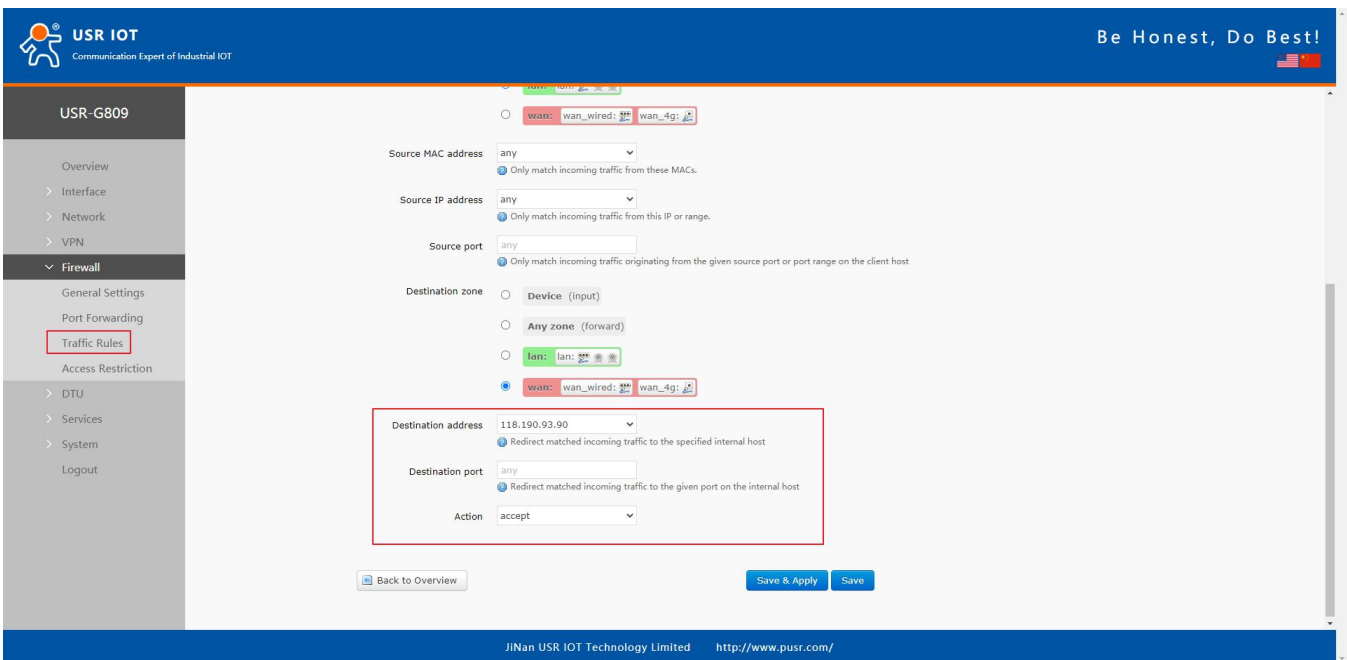

The screenshot shows the 'Traffic Rules' configuration page in the USR IOT web interface. The 'Destination address' is set to '118.190.93.90', the 'Destination port' is set to 'any', and the 'Action' is set to 'accept'. A red box highlights these three fields. Other fields include 'Name', 'Restrict to address family' (IPv4 only), 'Protocol' (TCP+UDP), 'Match ICMP type' (any), 'Source zone' (lan), 'Source MAC address' (any), 'Source IP address' (any), 'Source port' (any), and 'Destination zone' (wan).

Then we need to set another rule to reject all the communication, the source IP address and destination IP address are “any”, set the action to “reject”. Please note the order of the two rules, the accepted rule must come before the rejected rule.

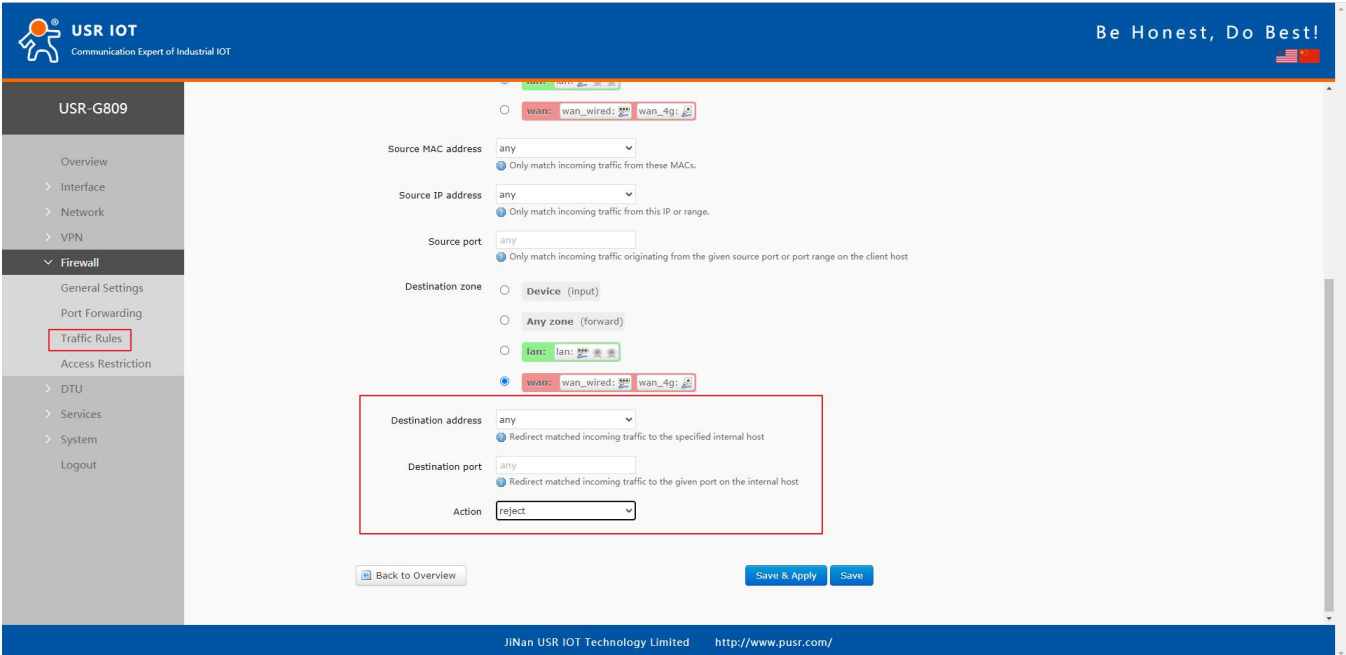

USR IOT Communication Expert of Industrial IOT

Be Honest, Do Best!

USR-G809

- Overview
- Interface
- Network
- VPN
- Firewall**
 - General Settings
 - Port Forwarding
 - Traffic Rules**
 - Access Restriction
- DTU
- Services
- System
- Logout

Source MAC address: any

Source IP address: any

Source port: any

Destination zone:

- Device (input)
- Any zone (forward)
- lan: lan
- wan: wan_wired; wan_4g**

Destination address: any

Destination port: any

Action: reject

Buttons: Back to Overview, Save & Apply, Save

JiNan USR IOT Technology Limited <http://www.pusr.com/>

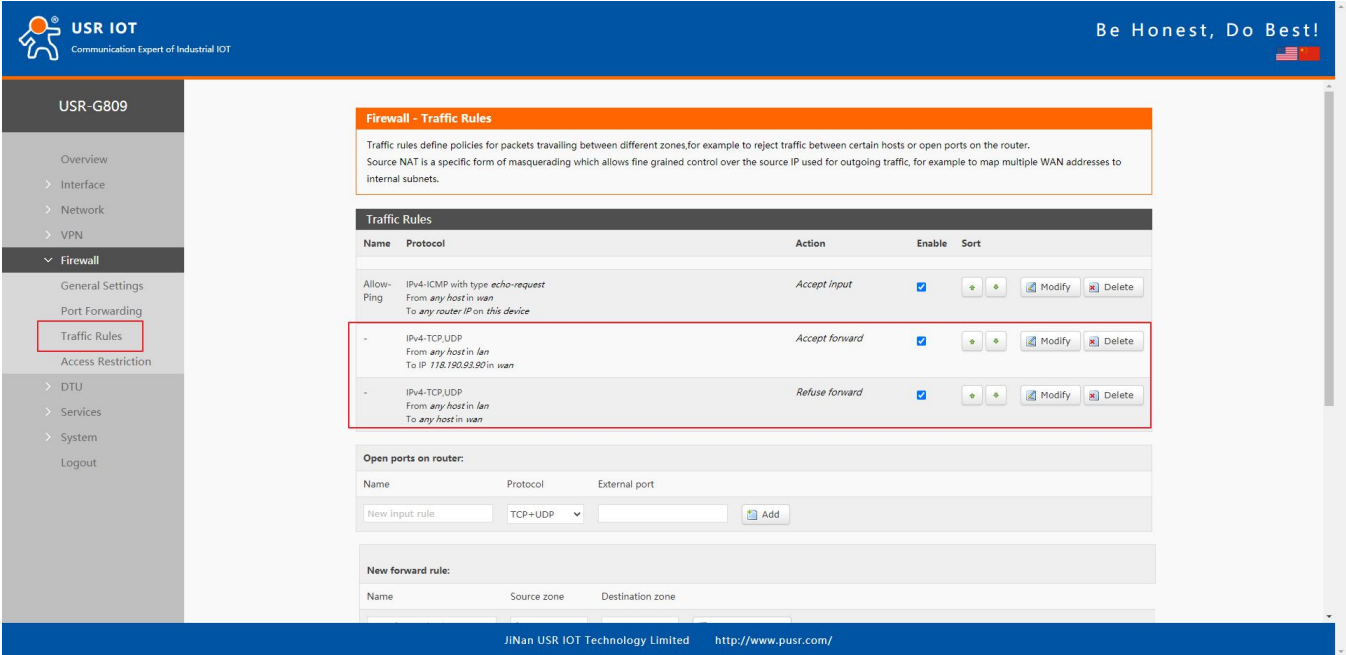

USR IOT Communication Expert of Industrial IOT

Be Honest, Do Best!

USR-G809

- Overview
- Interface
- Network
- VPN
- Firewall**
 - General Settings
 - Port Forwarding
 - Traffic Rules**
 - Access Restriction
- DTU
- Services
- System
- Logout

Firewall - Traffic Rules

Traffic rules define policies for packets travelling between different zones, for example to reject traffic between certain hosts or open ports on the router. Source NAT is a specific form of masquerading which allows fine grained control over the source IP used for outgoing traffic, for example to map multiple WAN addresses to internal subnets.

Name	Protocol	Action	Enable	Sort
Allow-Ping	IPv4-ICMP with type echo-request From any host in wan To any router IP on this device	Accept input	<input checked="" type="checkbox"/>	+
-	IPv4-TCP,UDP From any host in lan To IP 118.190.93.90 in wan	Accept forward	<input checked="" type="checkbox"/>	+
-	IPv4-TCP,UDP From any host in lan To any host in wan	Refuse forward	<input checked="" type="checkbox"/>	+

Open ports on router:

Name	Protocol	External port
New input rule	TCP+UDP	

New forward rule:

Name	Source zone	Destination zone

JiNan USR IOT Technology Limited <http://www.pusr.com/>

6.3.3. IP and Port Access Restrictions

Add a forward rule.

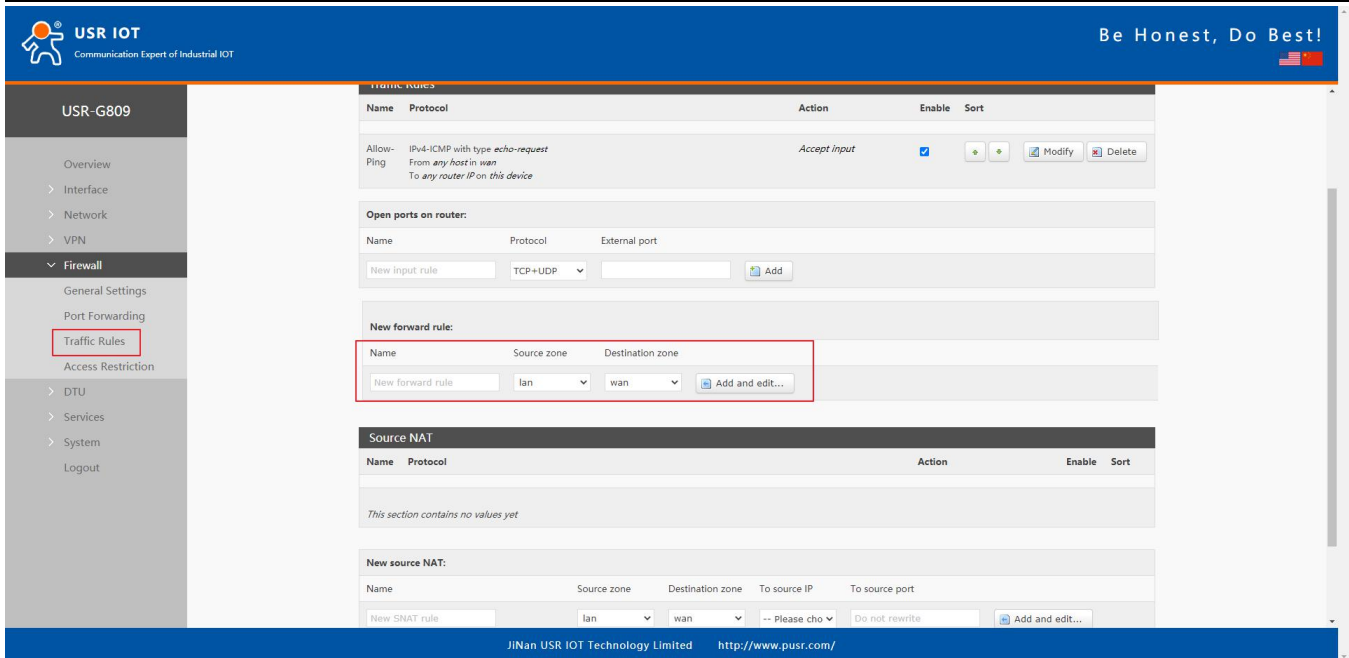

The screenshot shows the 'Traffic Rules' configuration page in the USR-G809 web interface. The 'New forward rule' section is highlighted with a red box, showing the following configuration:

Name	Source zone	Destination zone
New forward rule	lan	wan

The 'New input rule' section shows the following configuration:

Name	Protocol	External port
New input rule	TCP+UDP	

- Protocol TCP+UDP: the specified source IP can ping the destination IP address, but cannot establish TCP/UDP connection.
- Protocol ICMP: the specified source IP cannot ping the destination IP address, but can establish TCP/UDP connection.

Here we test with TCP protocol to disable a port of the LAN device from accessing a specified port of the destination IP.

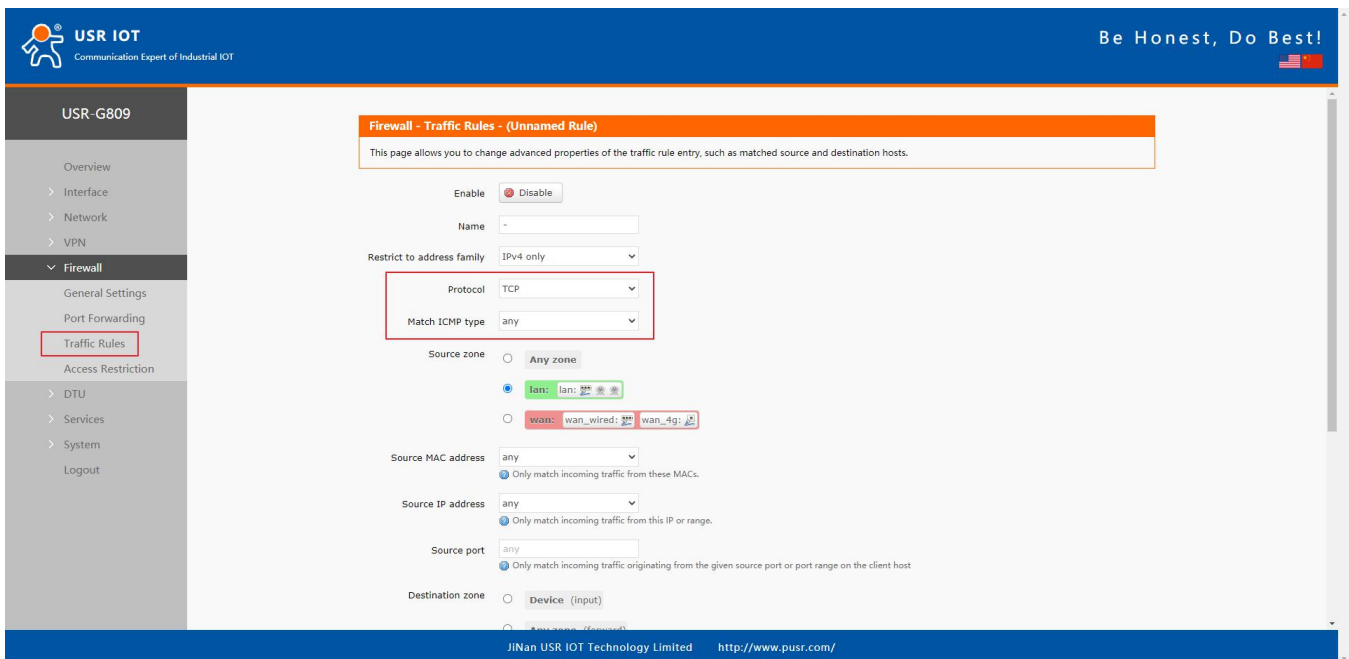

The screenshot shows the 'Firewall - Traffic Rules - (Unnamed Rule)' configuration page. The 'Protocol' is set to 'TCP' and 'Match ICMP type' is set to 'any'. The 'Source zone' is set to 'lan' and 'Source IP address' is set to 'any'.

Leave the source zone as default, fill in the source IP address or MAC address.

Here we disable a device with the MAC 4C:ED:FB:6A:F4:60 and port 8800 from establishing TCP connection with the destination IP 192.168.21.200 and port 8899.

Leave the source port and destination port to null means disable the TCP connection between the source device(4C:ED:FB:6A:F4:60) and the destination address 192.168.21.200.

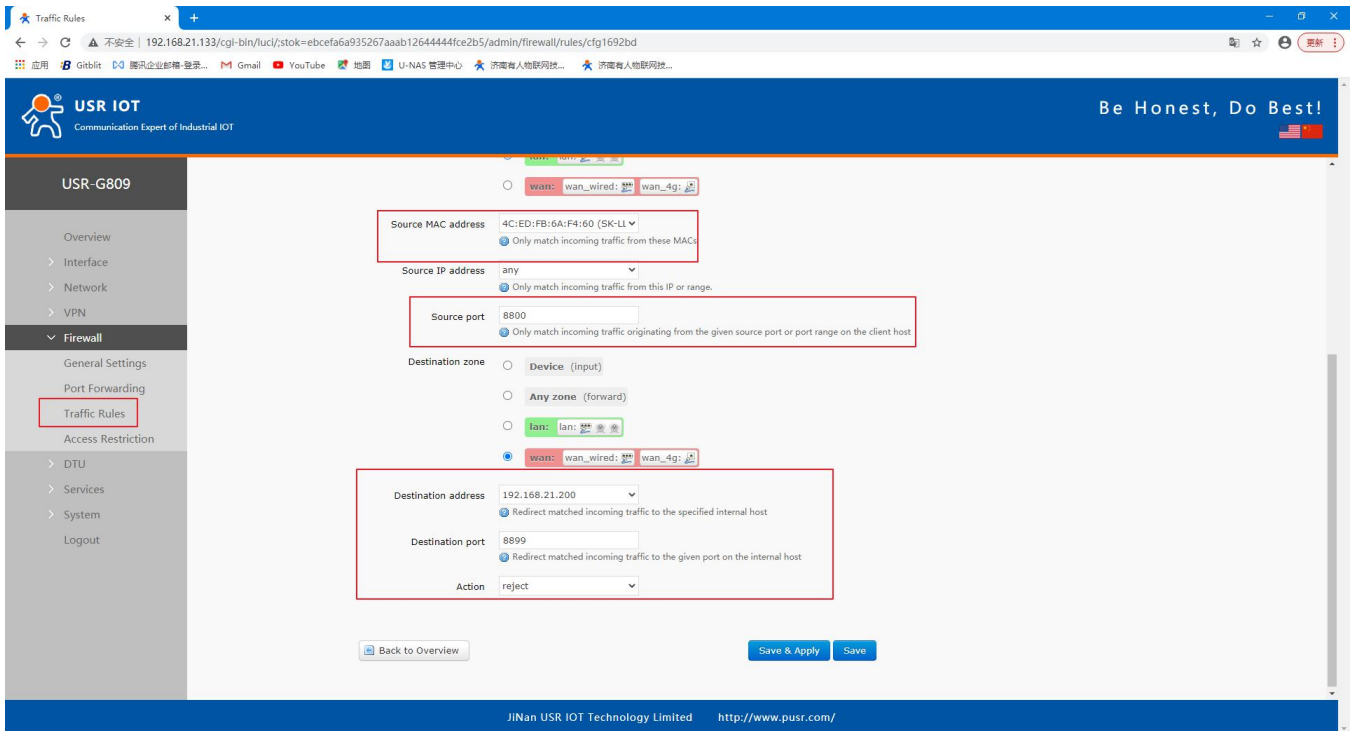

6.3.4. Ping Restrictions

The device can be ping by default, users can disable the ping function by changing the default rules.

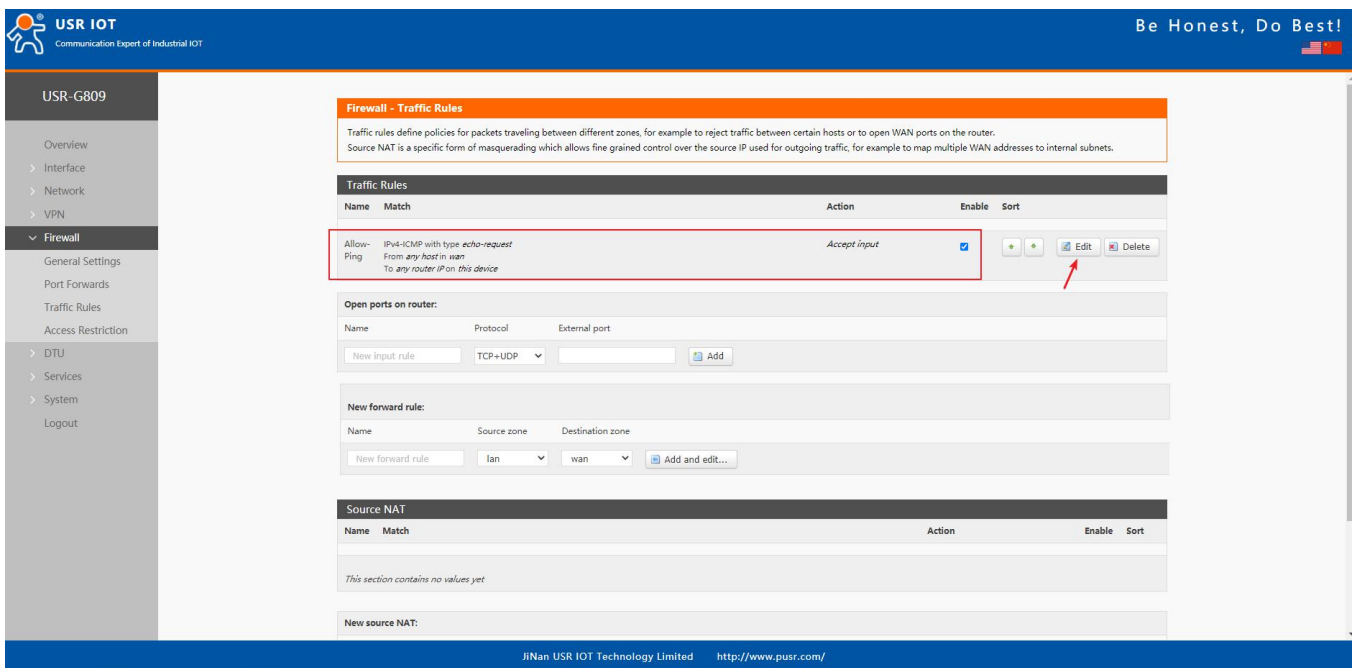

Name	Match	Action	Enable	Sort
Allow-Ping	IPv4-ICMP with type echo-request From any host in wan To any router IP on this device	Accept input	<input checked="" type="checkbox"/>	

In below example, we disable the ping function from the LAN IP 192.168.1.133 to all the destination IP addresses.

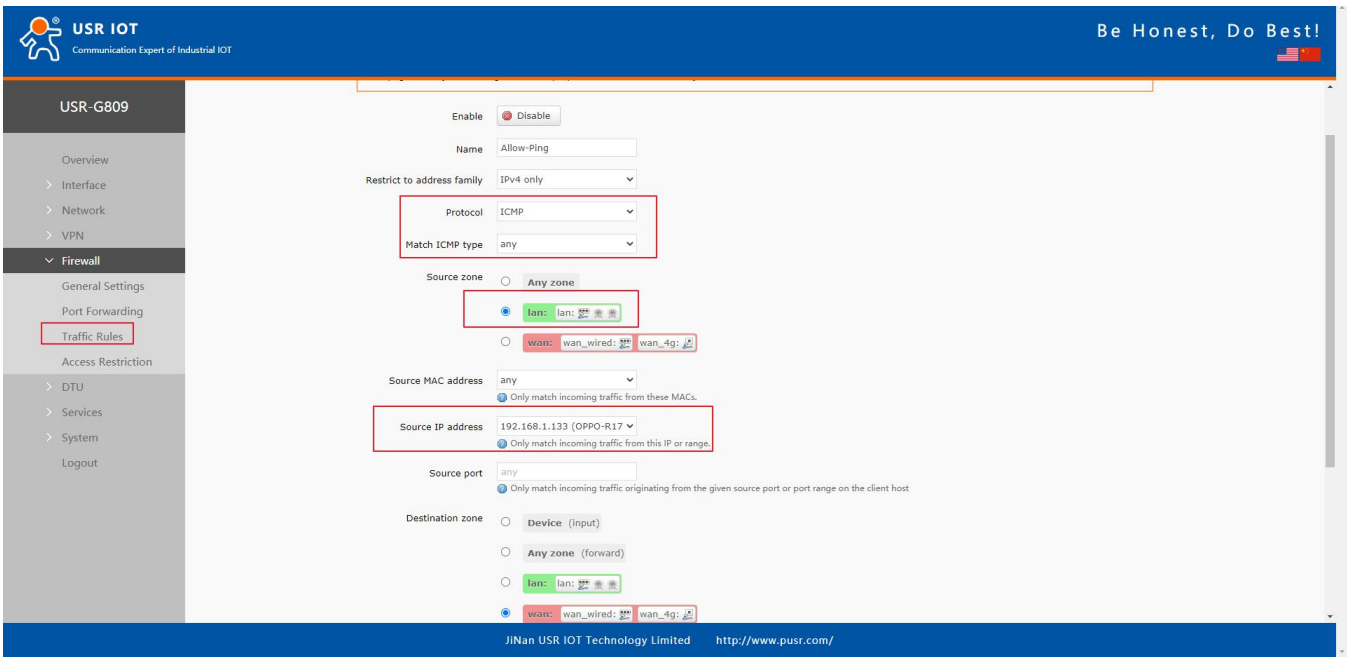

USR-G809

Overview

- Interface
- Network
- VPN
- Firewall
 - General Settings
 - Port Forwarding
 - Traffic Rules**
 - Access Restriction
- DTU
- Services
- System
- Logout

Enable: Enable Disable

Name: Allow-Ping

Restrict to address family: IPv4 only

Protocol: ICMP

Match ICMP type: any

Source zone:

- Any zone
- lan: lan
- wan: wan_wired: wan_4g

Source MAC address: any

Source IP address: 192.168.1.133 (OPPO-R17)

Source port: any

Destination zone:

- Device (input)
- Any zone (forward)
- lan: lan
- wan: wan_wired: wan_4g

JINan USR IOT Technology Limited <http://www.pusr.com/>

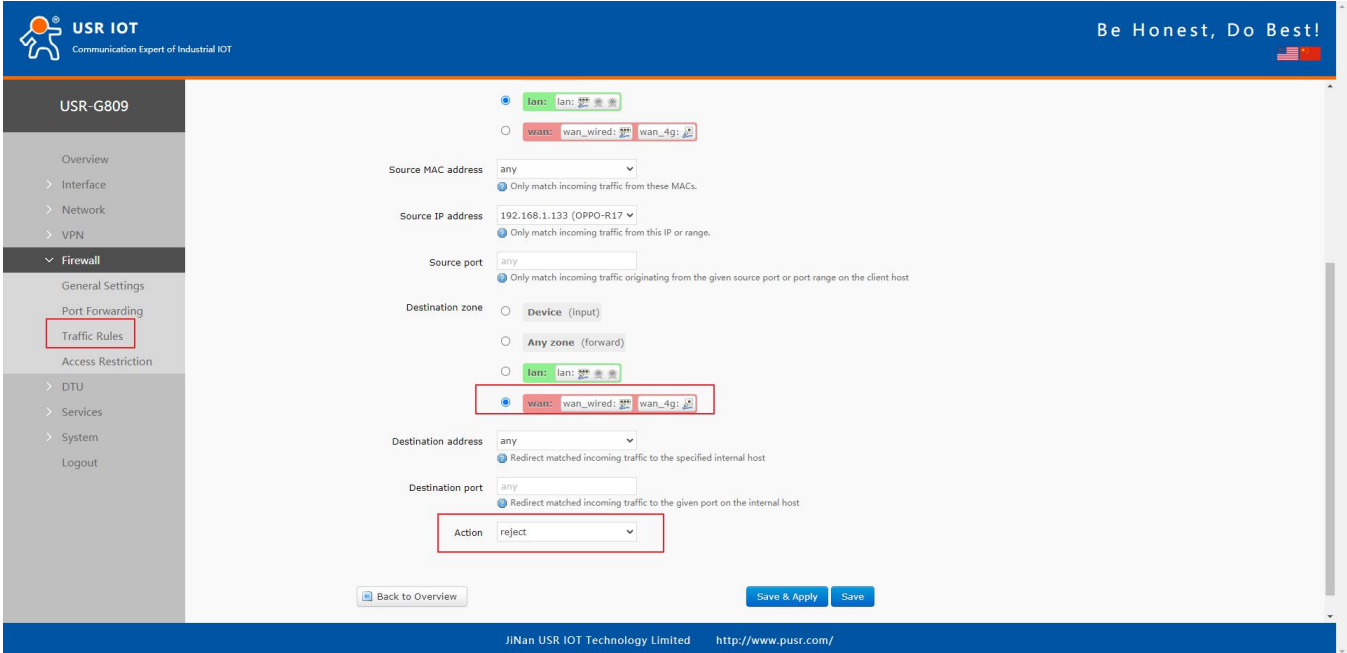

USR-G809

Overview

- Interface
- Network
- VPN
- Firewall
 - General Settings
 - Port Forwarding
 - Traffic Rules**
 - Access Restriction
- DTU
- Services
- System
- Logout

Source MAC address: any

Source IP address: 192.168.1.133 (OPPO-R17)

Source port: any

Destination zone:

- Device (input)
- Any zone (forward)
- lan: lan
- wan: wan_wired: wan_4g

Destination address: any

Destination port: any

Action: reject

Back to Overview Save & Apply Save

JINan USR IOT Technology Limited <http://www.pusr.com/>

Click "Save&Apply" to take the parameters effect.

6.4. Access Restriction

6.4.1. Black List

When we choose "Black list", the devices connected to the router cannot access the domain name in blacklist, but can access all other domain names. Here, the device can access the domain name except baidu.com.

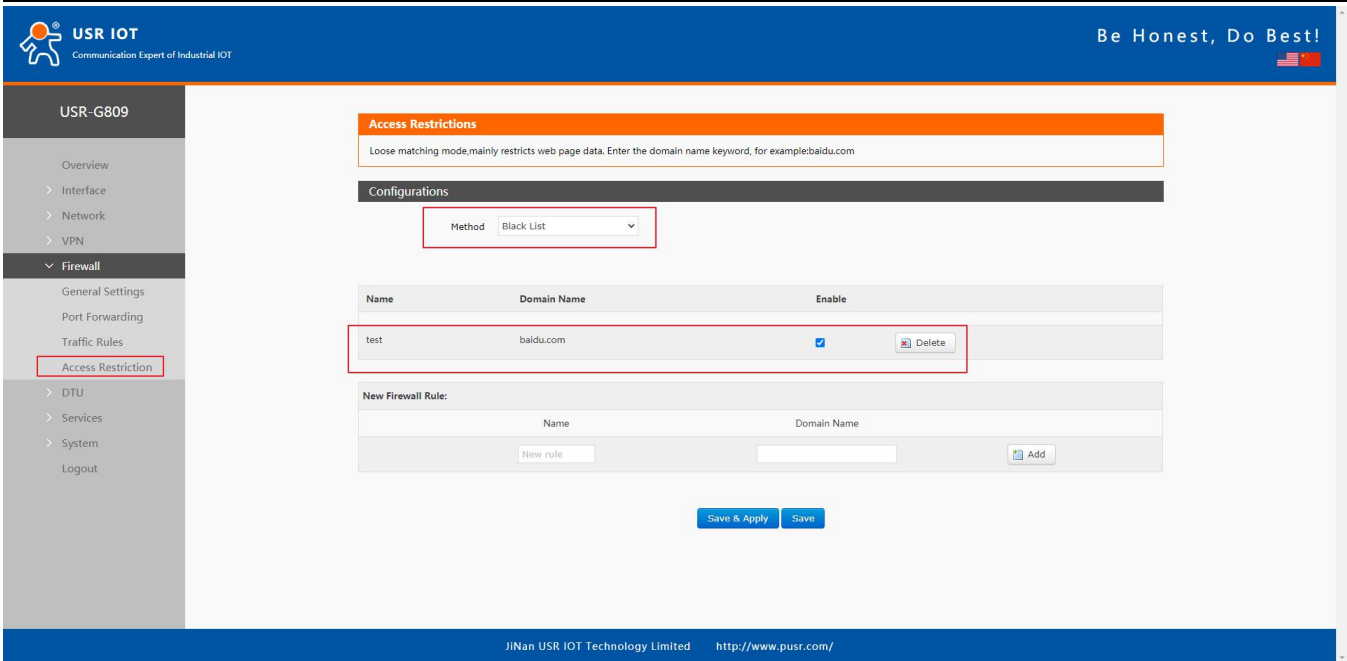

The screenshot shows the 'Access Restrictions' configuration page in the USR IOT web interface. The 'Method' dropdown is set to 'Black List'. A table lists a rule named 'test' with the domain 'baidu.com' and the 'Enable' checkbox checked. Below the table is a 'New Firewall Rule' section with input fields for 'Name' and 'Domain Name', and an 'Add' button. At the bottom, there are 'Save & Apply' and 'Save' buttons.

6.4.2. White List

After enable “White List”, the devices connected to the router can only access the domain name within whitelist. If just enable white list but do not add the rules, the device cannot access any domain name. Here, the device can only access baidu.com.

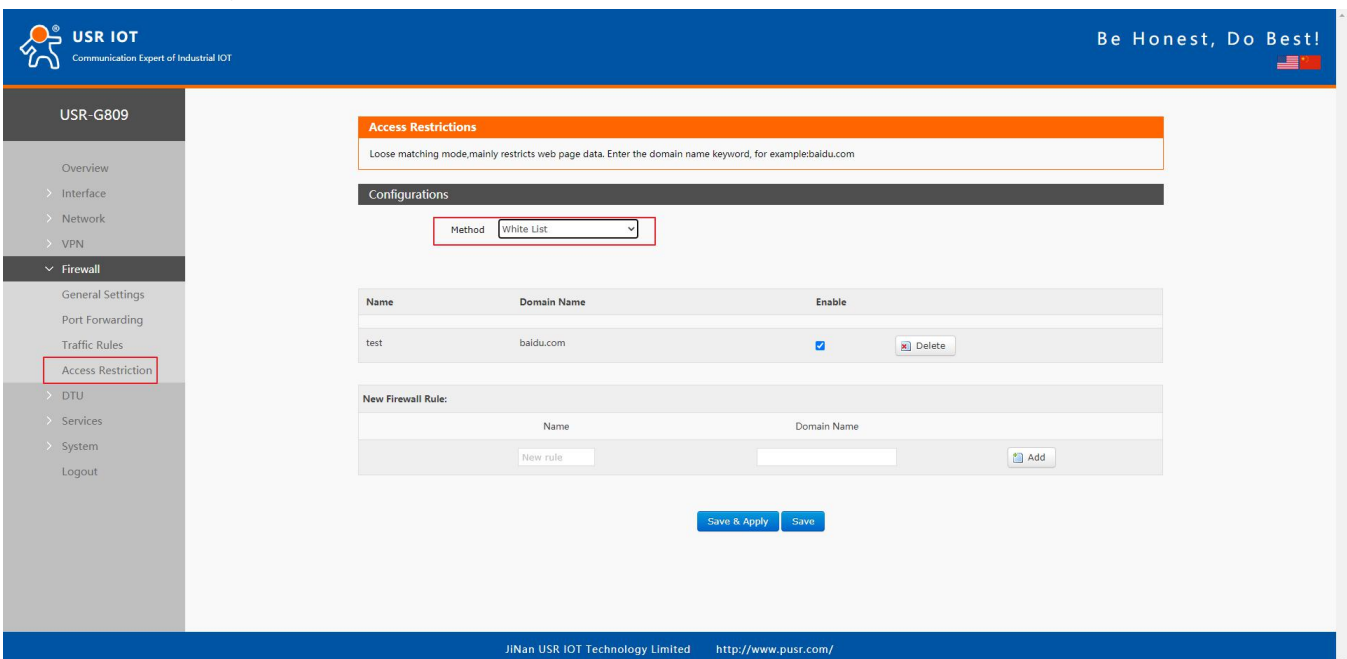

The screenshot shows the 'Access Restrictions' configuration page in the USR IOT web interface. The 'Method' dropdown is set to 'White List'. A table lists a rule named 'test' with the domain 'baidu.com' and the 'Enable' checkbox checked. Below the table is a 'New Firewall Rule' section with input fields for 'Name' and 'Domain Name', and an 'Add' button. At the bottom, there are 'Save & Apply' and 'Save' buttons.

7. Serial Port

USR-G809 supports DTU function, which can achieve RS232 or RS485 serial data transmission.

7.1. Connecting Hardware

RS232:

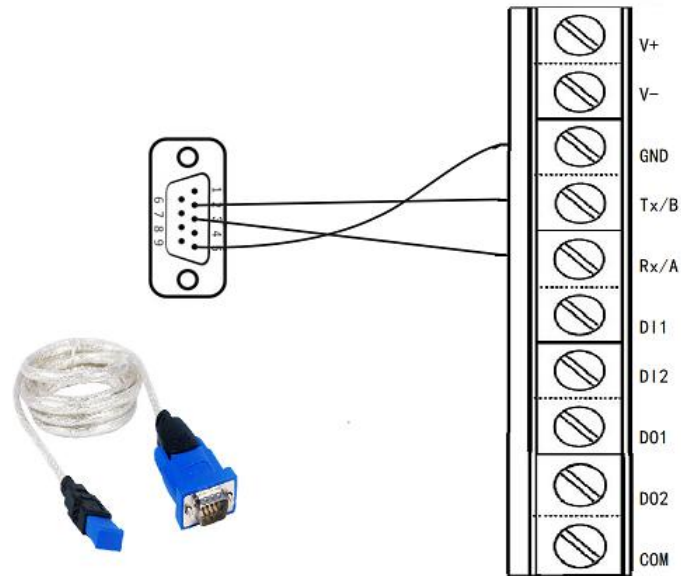

RS485:

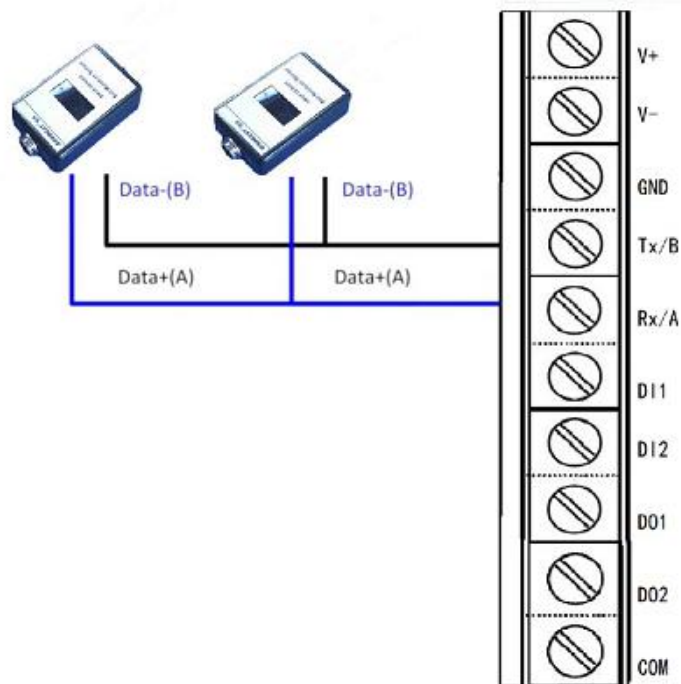

7.2. Serial Port Settings

7.2.1. Basic Settings

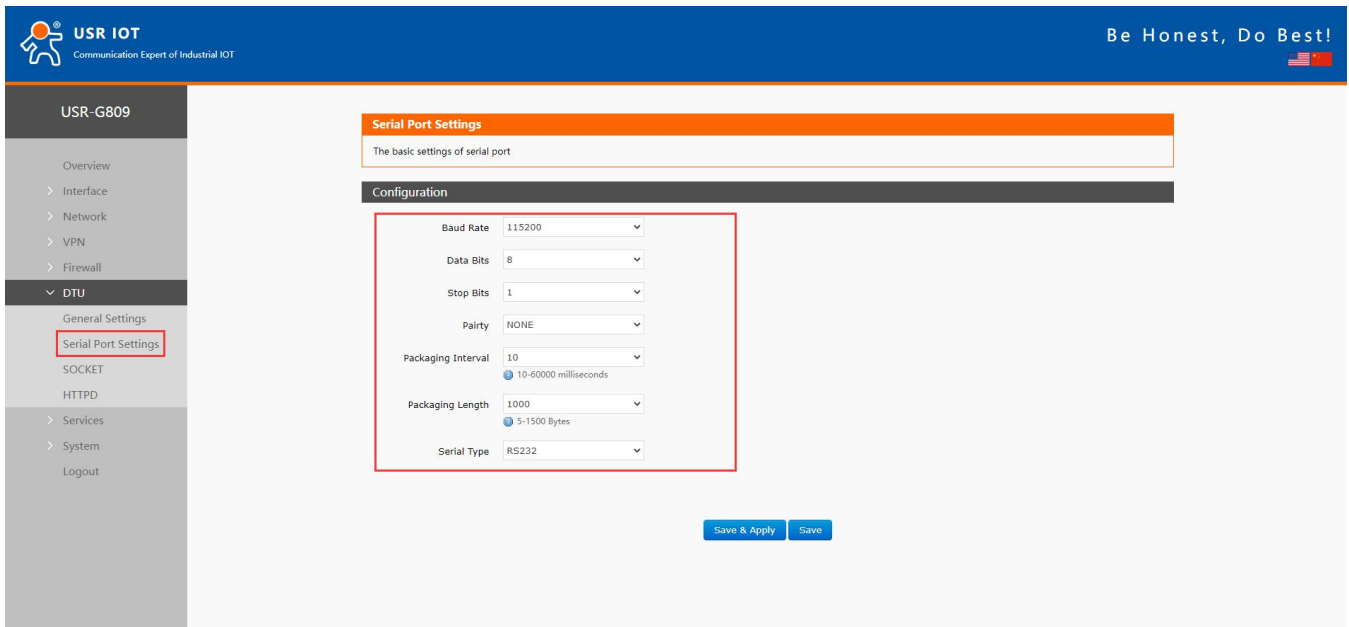

The screenshot shows the 'Serial Port Settings' configuration page in the USR IOT web interface. The page has a blue header with the USR IOT logo and the slogan 'Be Honest, Do Best!'. A left sidebar contains a navigation menu with 'DTU' expanded to show 'General Settings', where 'Serial Port Settings' is highlighted. The main content area is titled 'Serial Port Settings' and contains a 'Configuration' section with the following settings:

- Baud Rate: 115200
- Data Bits: 8
- Stop Bits: 1
- Parity: NONE
- Packaging Interval: 10
- Packaging Length: 1000
- Serial Type: RS232

At the bottom of the configuration section, there are two buttons: 'Save & Apply' and 'Save'.

Serial parameters of USR-G809 must be consistent with the RS232 or RS485 serial device. Otherwise, they cannot communicate with each other.

Item	Description	Default
Baud rate	Supports 1200/2400/4800/9600/19200/38400/57600/115200/230400	115200
Data bits	8	8
Stop bits	1 /2	1
Parity	NONE/ODD/EVEN	NONE
Packaging interval (ms)	10-60000	10
Packaging length(byte)	5-1500	1000
Serial type	RS232/RS485	RS232

7.2.2. Framing Mechanism

7.2.2.1. Time Trigger

When G809 receives data from the UART, it continuously checks the interval of two adjacent bytes. If the interval time is greater or equal to a certain "time threshold", then a frame is considered finished, otherwise the data is received until greater or equal to the packet length byte set (Defaults to 1000 bytes). This frame is sent to the network as a TCP or UDP packet. The "time threshold" here is the time between packages. The range of settable is 10ms~60000ms. Factory default: 10ms.

This parameter can be set by AT command, AT+UARTFT=<time>.

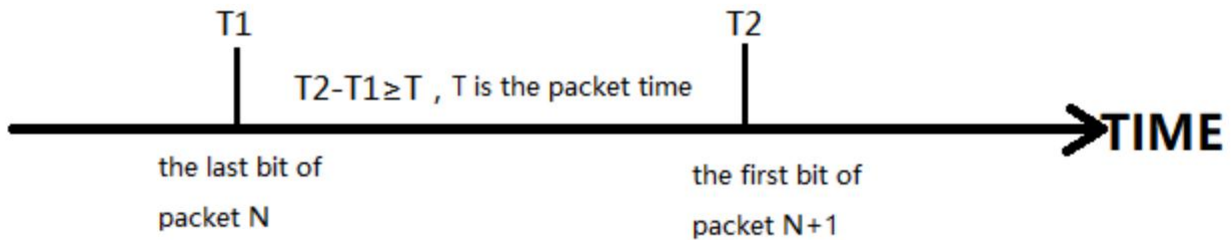

7.2.2.2. Length Trigger

When G809 receives data from the UART, it constantly checks the number of bytes received. If the number of bytes received is equal to a certain "length threshold", a frame is considered to have ended, then this frame is sent to the network as a TCP or UDP packet. The "length threshold" here is the package length. The settable range is 5~1500 bytes. Factory default 1000.

This parameter can be set by AT command, AT+UARTFL=<length>.

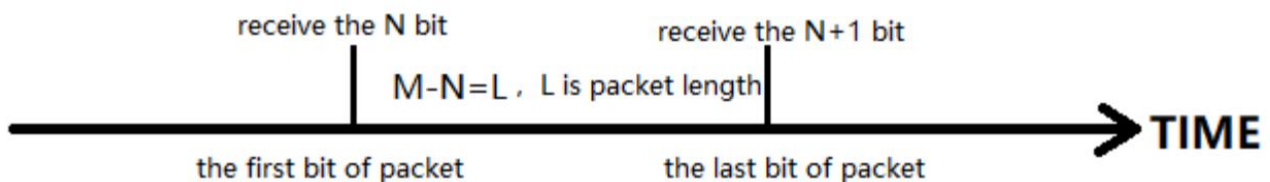

7.3. Operation Mode

USR-G809 supports three operation modes: NET(Transparent transmission), MODBUS(MODBUS RTU to MODBUS TCP), HTTPD(HTTP Client mode).

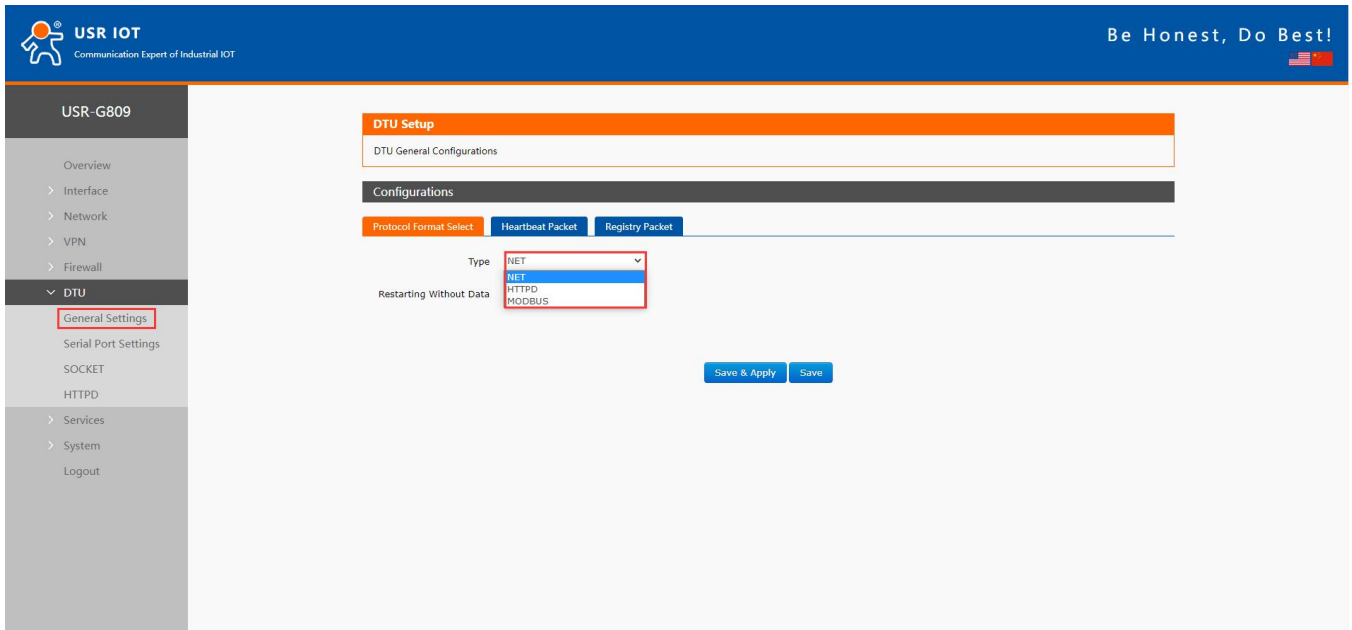

7.3.1.NET Mode

In this mode, user can achieve transparent data transmission between the serial device and the network server with simple parameter settings.

USR-G809 supports 4 socket connections, socket A~socket D, which are independent with each other.

Socket A supports TCP client/TCP server, UDP client/server, socket B/C/D supports TCP client, UDP client/server.

Here we connect the RS485 port to the computer via a serial to USB adaptor to test:

1. Set the operation mode to NET.

USR IOT
Communication Expert of Industrial IOT

Be Honest, Do Best!

USR-G809

Overview
> Interface
> Network
> VPN
> Firewall
DTU
General Settings
Serial Port Settings
SOCKET
HTTPD
> Services
> System
Logout

DTU Setup
DTU General Configurations

Configurations

Protocol Format Select | Heartbeat Packet | Registry Packet

Type: NET
Restarting Without Data: OFF

Save & Apply Save

2. Set the serial port parameters.

USR IOT
Communication Expert of Industrial IOT

Be Honest, Do Best!

USR-G809

Overview
> Interface
> Network
> VPN
> Firewall
DTU
General Settings
Serial Port Settings
SOCKET
HTTPD
> Services
> System
Logout

Serial Port Settings
The basic settings of serial port

Configuration

Baud Rate: 115200
Data Bits: 8
Stop Bits: 1
Parity: NONE

Packaging Interval: 10
Packaging Length: 1000
Serial Type: RS485

Save & Apply Save

3. Set the device to TCP client, server address to test.usr.cn, port 2317.

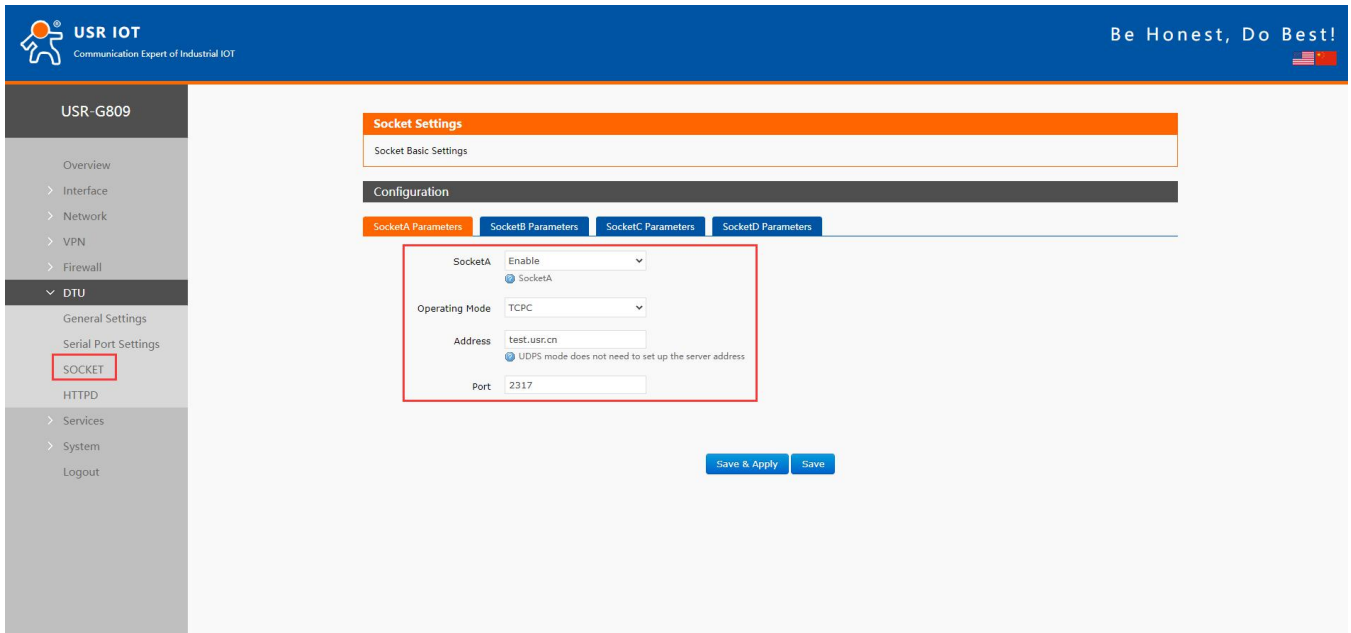

4. After setting all parameters, restart the device to take the parameters effect.

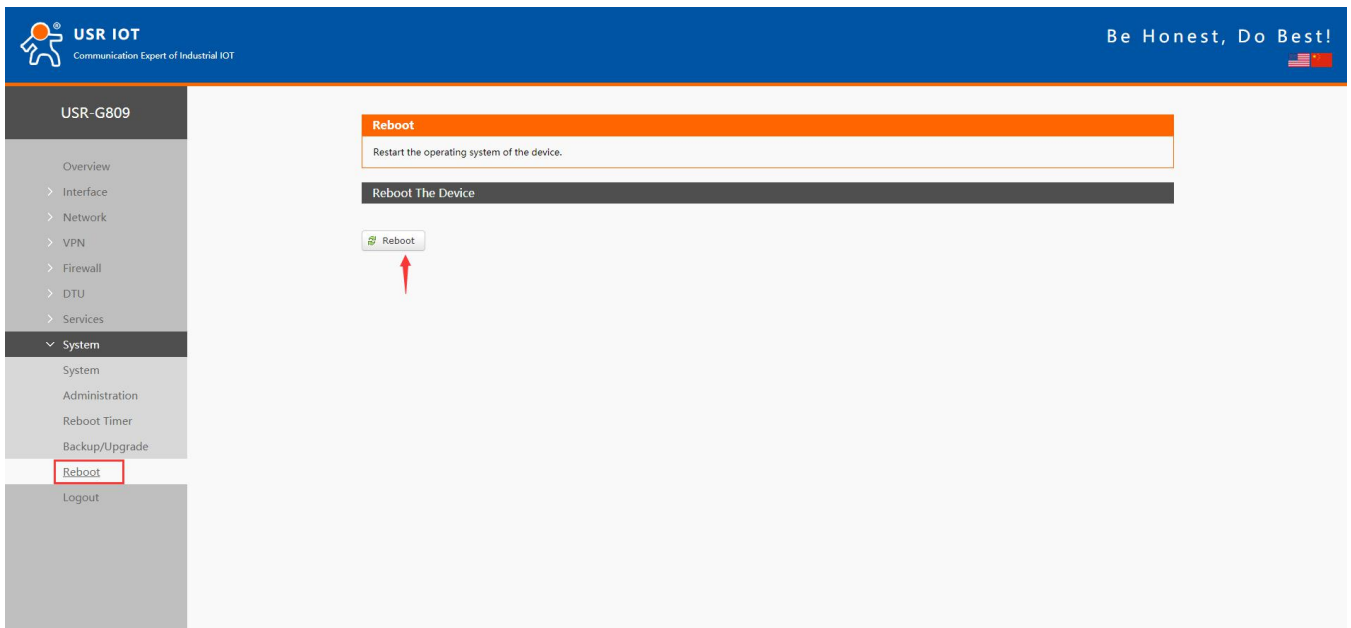

5. After the device restarts, when we send data from the serial port, will receive the same data replied by the test server.

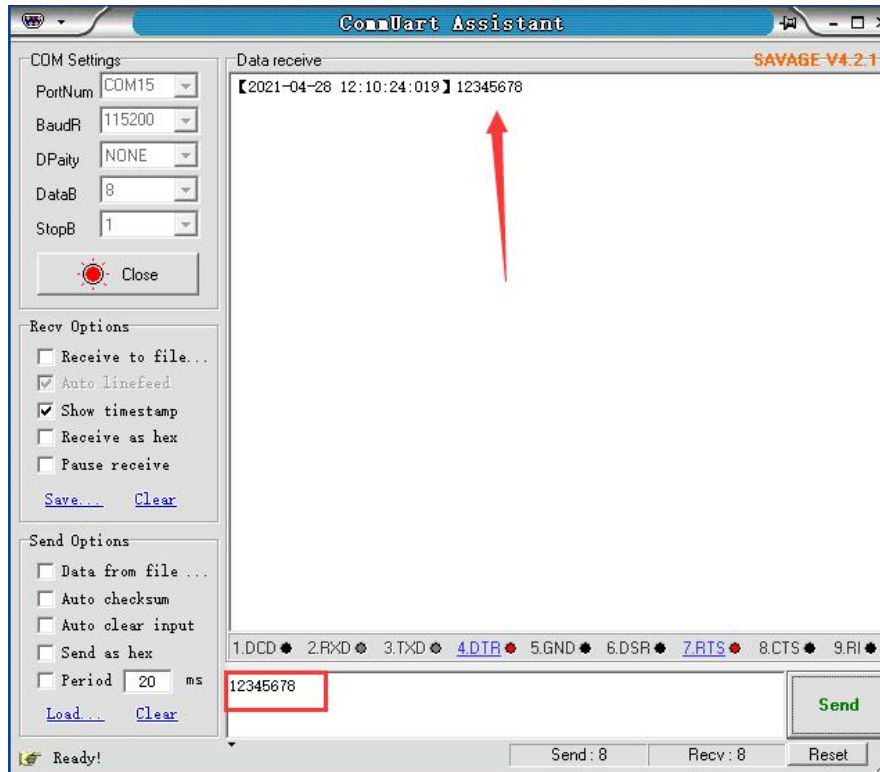

7.3.2. MODBUS Mode

In this mode, USR-G809 can achieve bidirectional protocol conversion between serial MODBUS RTU data and network MODBUS TCP data.

MODBUS mode supports 4 socket connections, which are independent with each other.

Socket A supports TCP client/server, socket B/C/D only supports TCP client.

7.3.3. HTTPD Mode

In this mode, user's serial device can send request data to the HTTP server. USR-G809 will resolve the server data then send to serial device. It will remove the HTTP header of the server data by default, users can set whether to enable this function via AT commands.

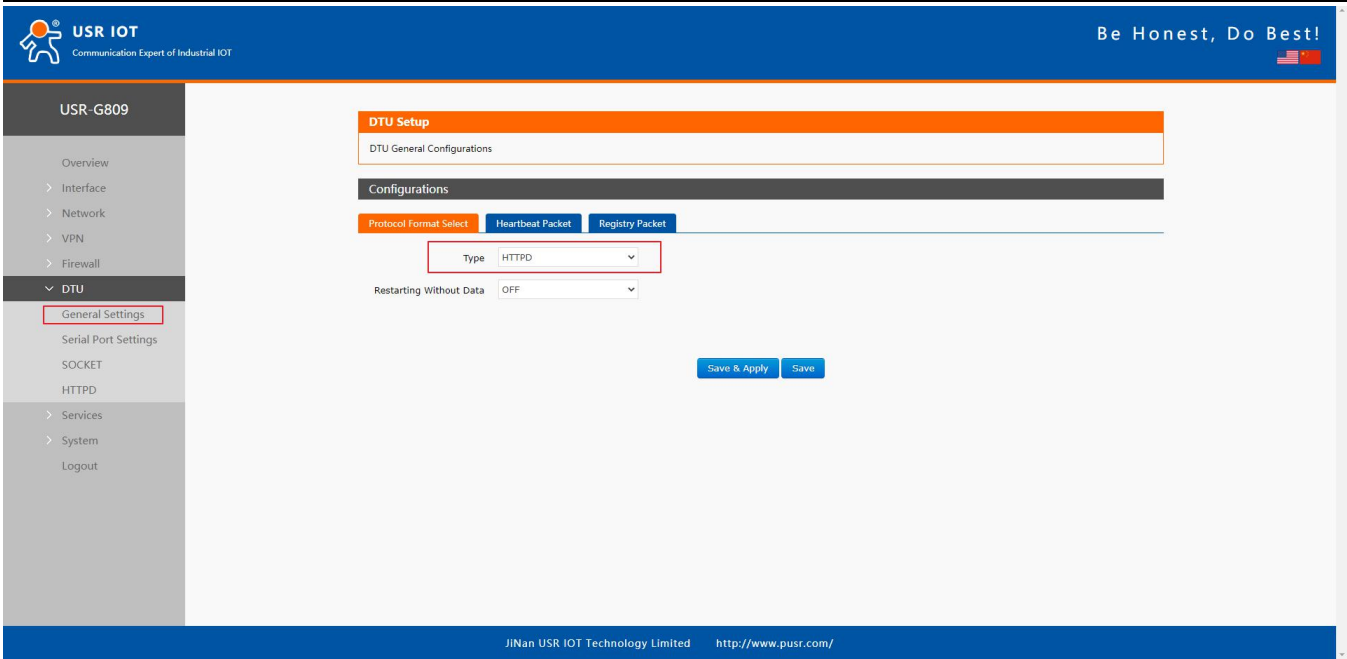
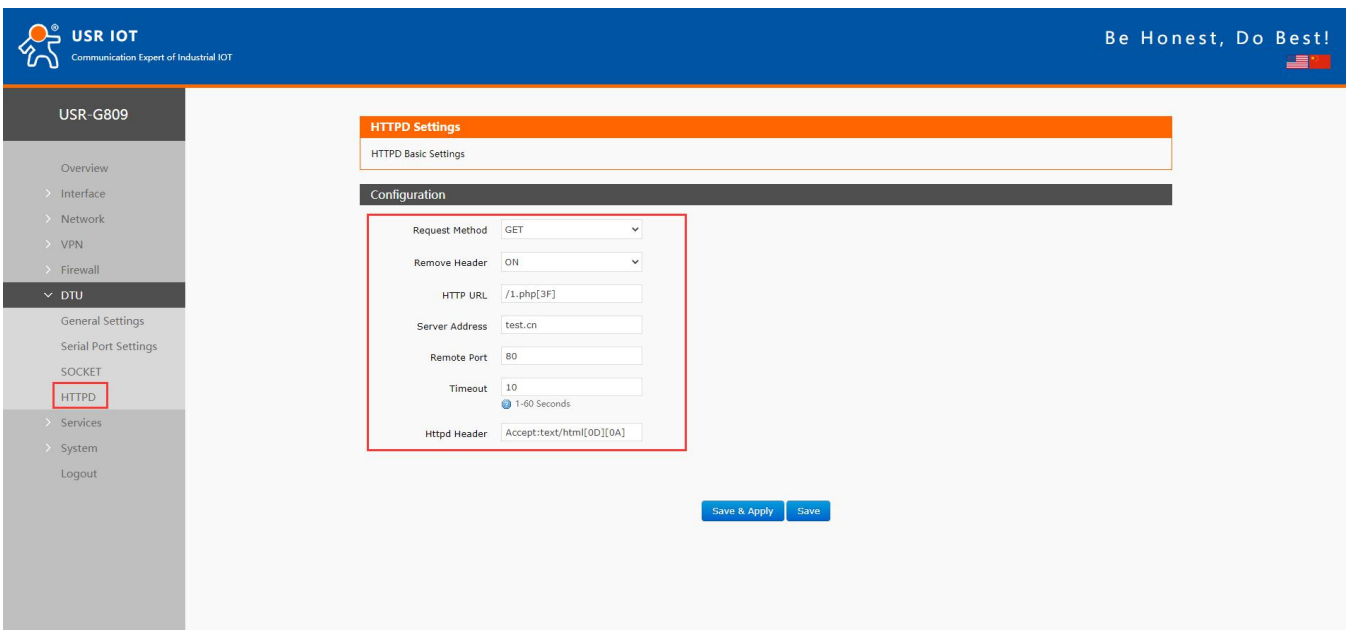
7.4. General Function

7.4.1. Registry Packet

Registry packet is intended to allow the server to identify the data from which device or to use it as a password to obtain authorization for the server's functions. Registry packet can be sent when the module establishes a connection with the server, or be added as the prefix of each data package. Registry packet data can be ICCID code, IMEI code, or User-defined data.

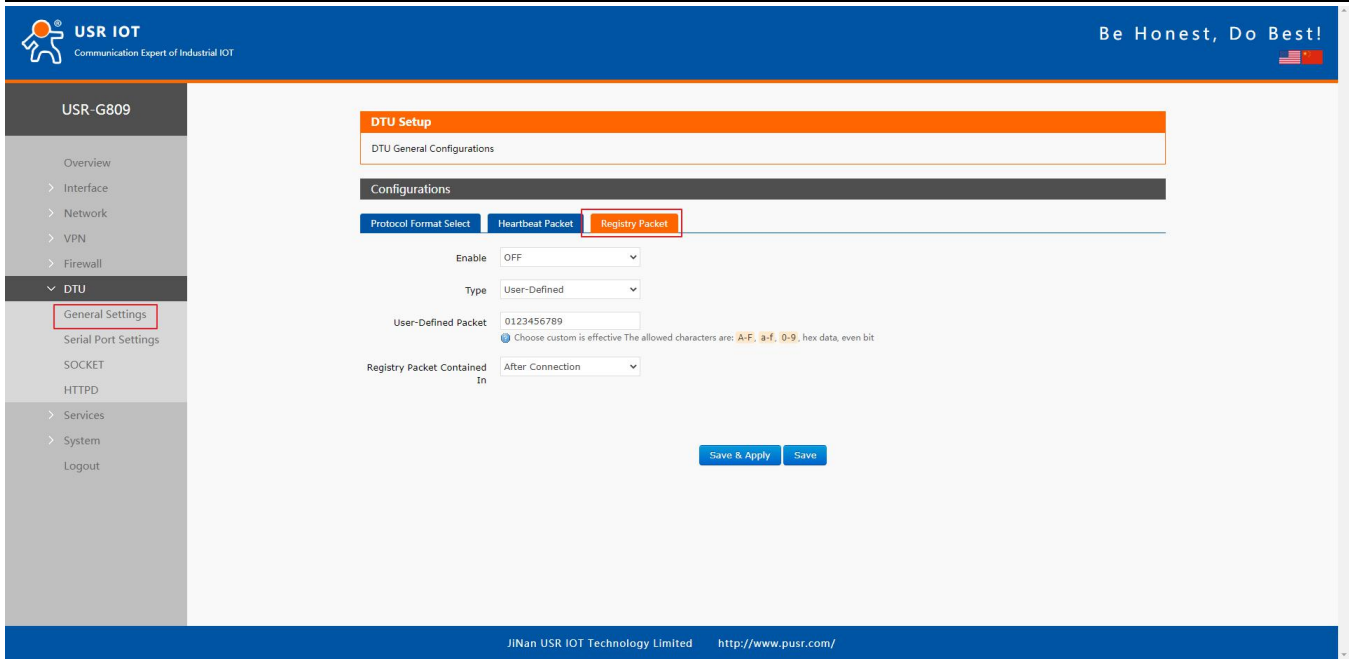

Item	Description	Default
Enable	ON/OFF	OFF
Type	IMEI, ICCID, USR Cloud, User-Defined	User-Defined
User-Defined packet	A-F, a-f, 0-9, hex data, even bit	0123456789
Cloud ID	Registry packet parameters of USR Cloud	SN code
Cloud psw	Registry packet parameters of USR Cloud	12345678
Registry packet contained in	After connection: Send once when establish a connection with the server. Prefix of data: Registry packet is added as the prefix of each data packet.	After connection

Note: Registry packet is only valid in TCPC, UDPC mode.

7.4.2. Heartbeat Packet

Heartbeat package can be sent to the network or serial port device. G809 defaults to send to the network to keep the connection stable and reliable.

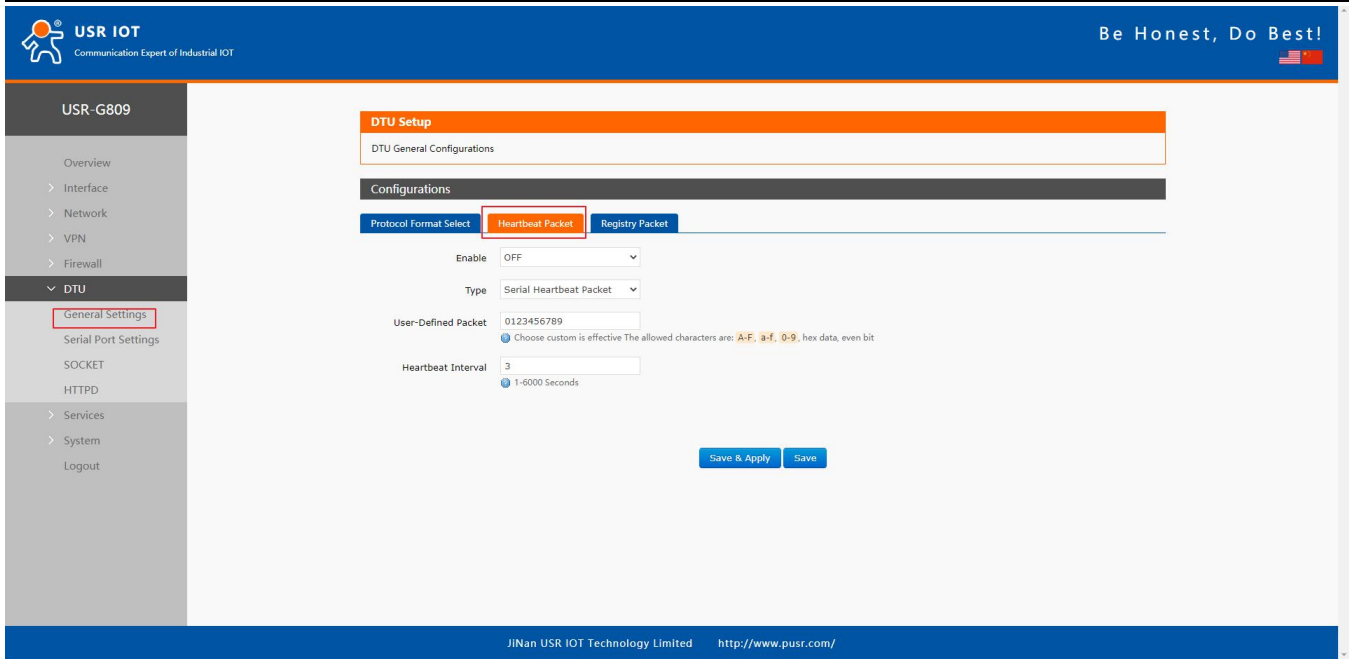

Item	Description	Default
Enable	ON/OFF	OFF
Type	Serial heartbeat packet/Network heartbeat packet	Network heartbeat packet
User-defined packet	A-F, a-f, 0-9, hex data, even bit	0123456789
Heartbeat interval (s)	1-6000s	3

Note: Heartbeat packet is only valid in TCPC, UDPC mode.

7.4.3. Restarting Without Data

This function defaults to be disabled. When it is enabled, the device can actively disconnect the connection with the server and reconnect when there is no data from network side within the reconnect detection interval, which can prevent pseudo-connection due to an abnormal socket disconnection.

When the time reaches the restart detection interval, the device will restart automatically to recover the connection.

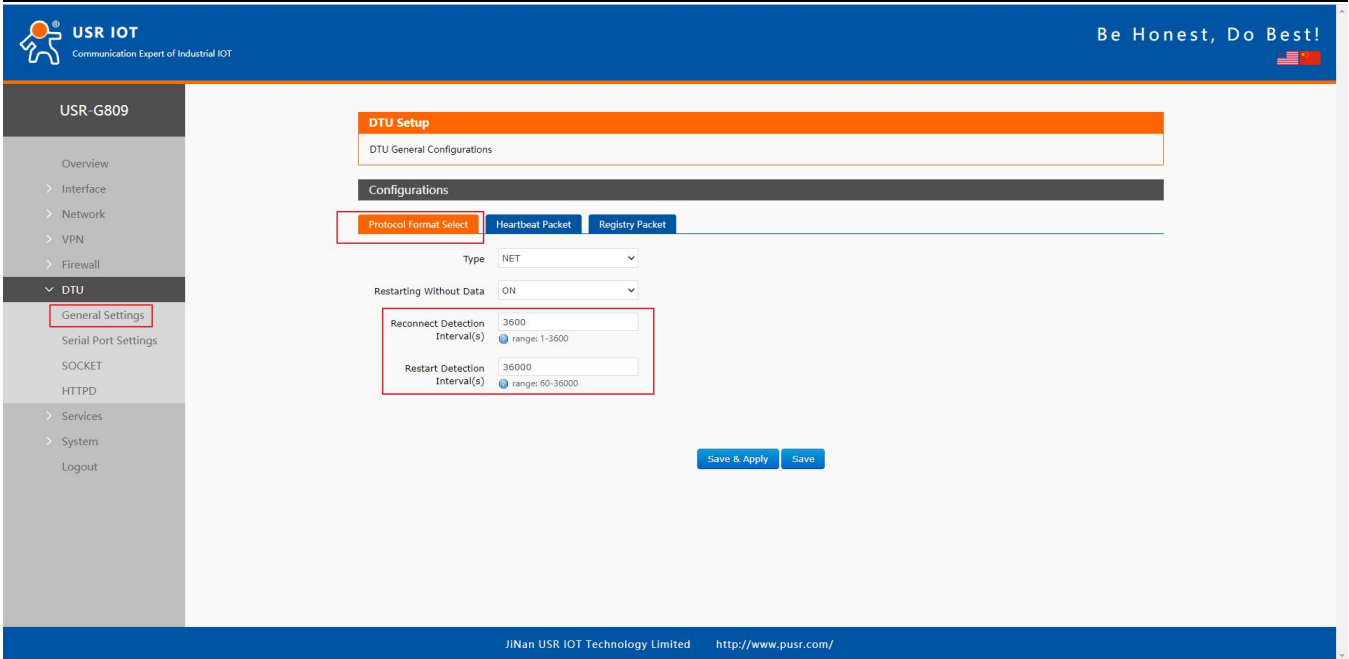

The screenshot displays the web management interface for the USR-G809 device. The top navigation bar includes the USR IOT logo and slogan, and the slogan is repeated on the right. A left sidebar menu lists various configuration categories, with 'DTU' expanded to show 'General Settings', 'Serial Port Settings', 'SOCKET', and 'HTTPD'. The main content area is titled 'DTU Setup' and contains a 'DTU General Configurations' section. Underneath, there are tabs for 'Protocol Format Select', 'Heartbeat Packet', and 'Registry Packet'. The 'Protocol Format Select' tab is active, showing a 'Type' dropdown menu set to 'NET' and a 'Restarting Without Data' dropdown set to 'ON'. Below these are two input fields for detection intervals: 'Reconnect Detection Interval(s)' set to 3600 (range: 1-3600) and 'Restart Detection Interval(s)' set to 36000 (range: 60-36000). At the bottom of the configuration area are 'Save & Apply' and 'Save' buttons. The footer of the interface contains the text 'Jinan USR IOT Technology Limited' and the URL 'http://www.pusr.com/'.

Note:

- After parameters settings, restart the device to take the parameters effect.
- This function is only valid in NET/MODBUS mode.

7.4.4.RFC2217

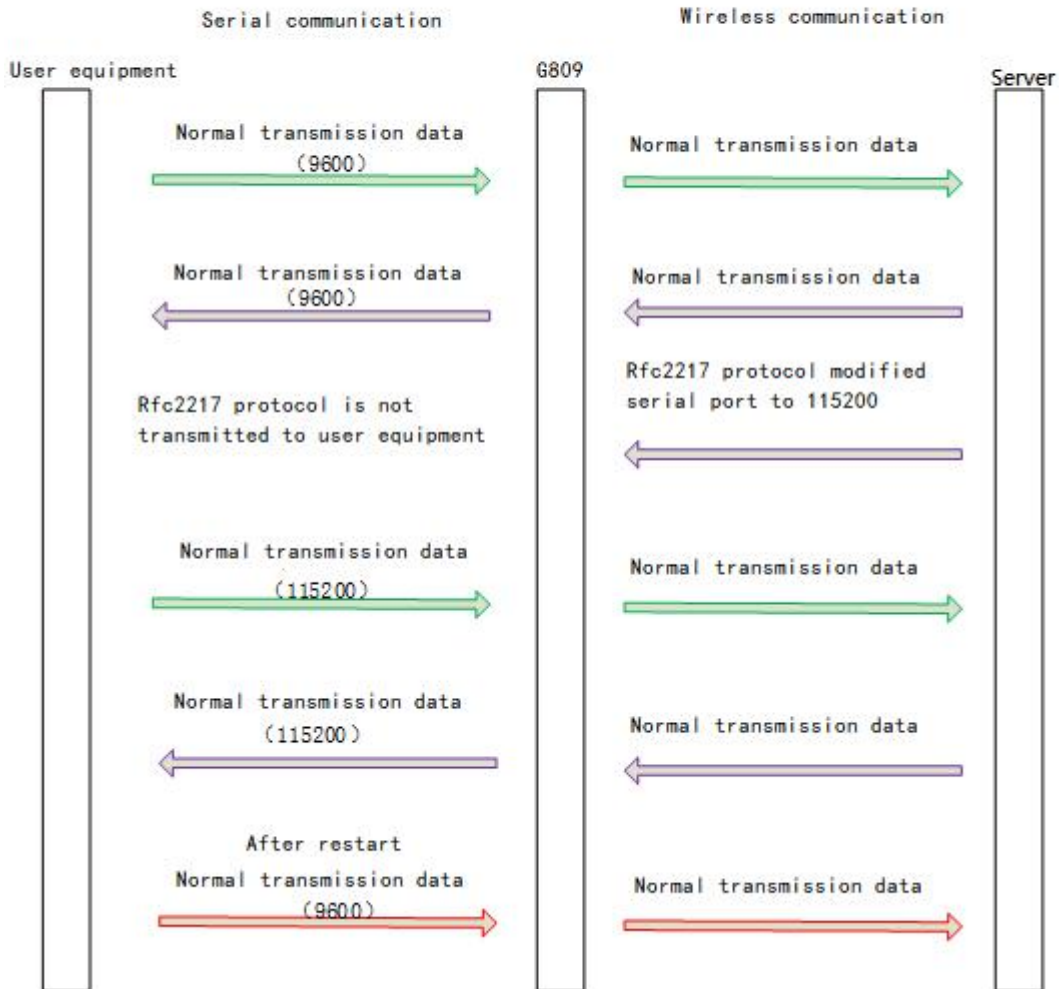

This function is similar to RFC2217, when we send the specific protocol data from the network side, can change the serial parameters in real time. Parameters take effect immediately, but it will be restored to the original after restarting.

Protocol description:

The protocol length is 8 bytes in HEX:

Item	Header	Baud rate	Bit	Parity
Bytes	3	3	1	1
Description	3 bytes reduce misjudgment	A baud rate value, high first	Please check below table	Parity of the first four digits, ignoring carry.

Example: (115200,N,8,1)	55 AA 55	01 C2 00	83	46
Example: (9600,N,8,1)	55 AA 55	00 25 80	83	28

Bit	Description	Value	Description
1:0	Data bit	00	5
		01	6
		10	7
		11	8
2	Stop bit	0	1
		1	2
3	Parity	0	Disable
		1	Enable
5:4	Parity type	00	ODD
		01	EVEN
		10	Mark
7:6	NC	00	0

Note: This function needs to be enabled via AT command: AT+RFCEN.

8. USR Cloud

USR Cloud address: mp.usriot.com (Please register an account first)

USR-G809 enables USR Cloud service by default. User can configure the traffic flow record parameters, net status parameters and heartbeat parameters. It also support reporting the device status to the USR Cloud with privatization.

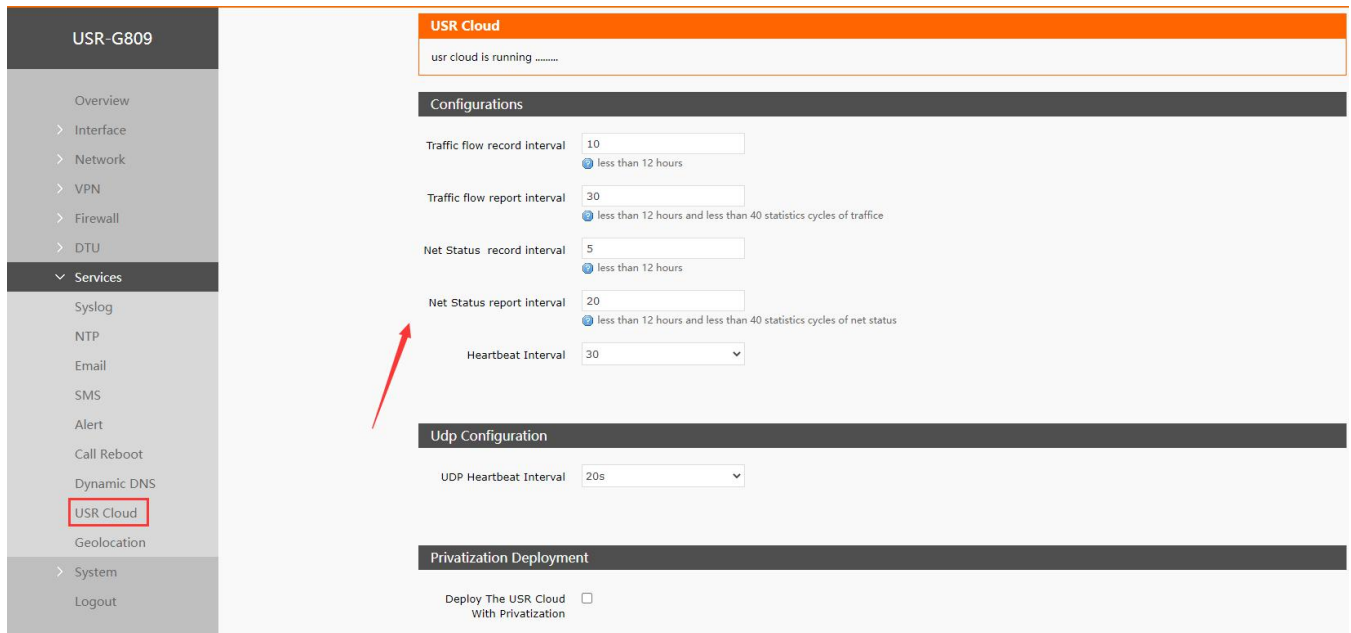

The screenshot shows the configuration page for USR Cloud. On the left is a navigation menu with 'USR Cloud' highlighted. The main content area is titled 'USR Cloud' and includes a status indicator 'usr cloud is running'. Below this are three configuration sections:

- Configurations:**
 - Traffic flow record interval: 10
 - Traffic flow report interval: 30 (radio button selected for 'less than 12 hours and less than 40 statistics cycles of traffic')
 - Net Status record interval: 5
 - Net Status report interval: 20 (radio button selected for 'less than 12 hours and less than 40 statistics cycles of net status')
 - Heartbeat Interval: 30
- Udp Configuration:**
 - UDP Heartbeat Interval: 20s
- Privatization Deployment:**
 - Deploy The USR Cloud With Privatization:

8.1. Cloud Monitor

Cloud monitor displays the online devices, models, firmware version, alarm information and new device.

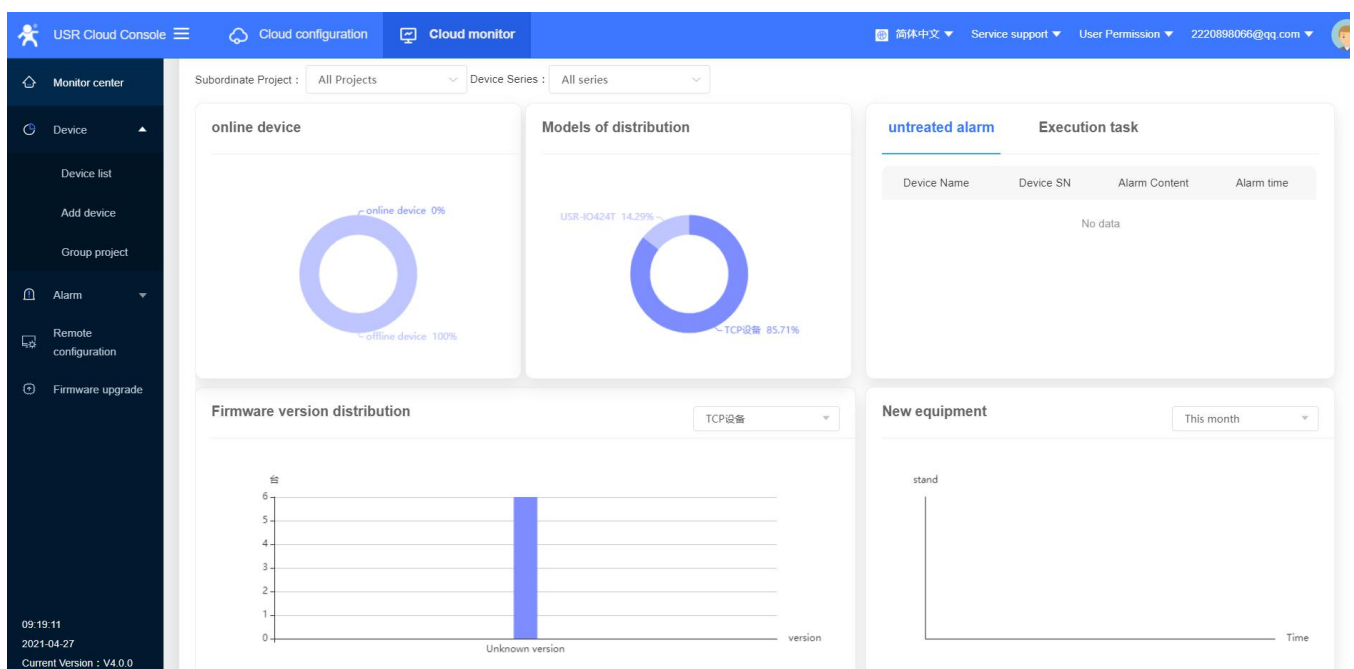

The screenshot shows the 'Cloud monitor' interface in the USR Cloud Console. It features a sidebar with navigation options like 'Monitor center', 'Device', 'Alarm', and 'Firmware upgrade'. The main area contains several dashboards:

- online device:** A donut chart showing 0% online devices and 100% offline devices.
- Models of distribution:** A donut chart showing the distribution of device models, with 'USR-40424T' at 14.29% and 'TCP设备' at 85.71%.
- untreated alarm:** A table with columns for Device Name, Device SN, Alarm Content, and Alarm time. It currently shows 'No data'.
- Firmware version distribution:** A bar chart showing the distribution of firmware versions, with a single bar for 'Unknown version'.
- New equipment:** A line chart showing the number of new equipment over time, with a single data point for 'stand'.

8.2. Add device

Please add the device according to the device MAC/IMEI and SN in the label.

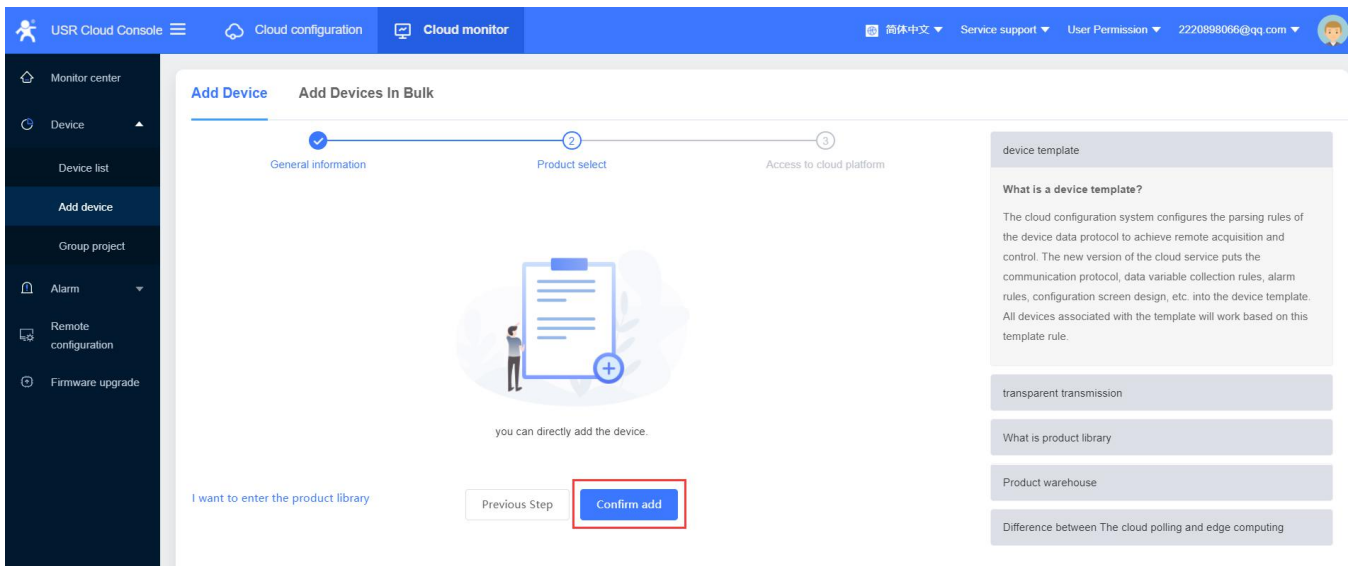
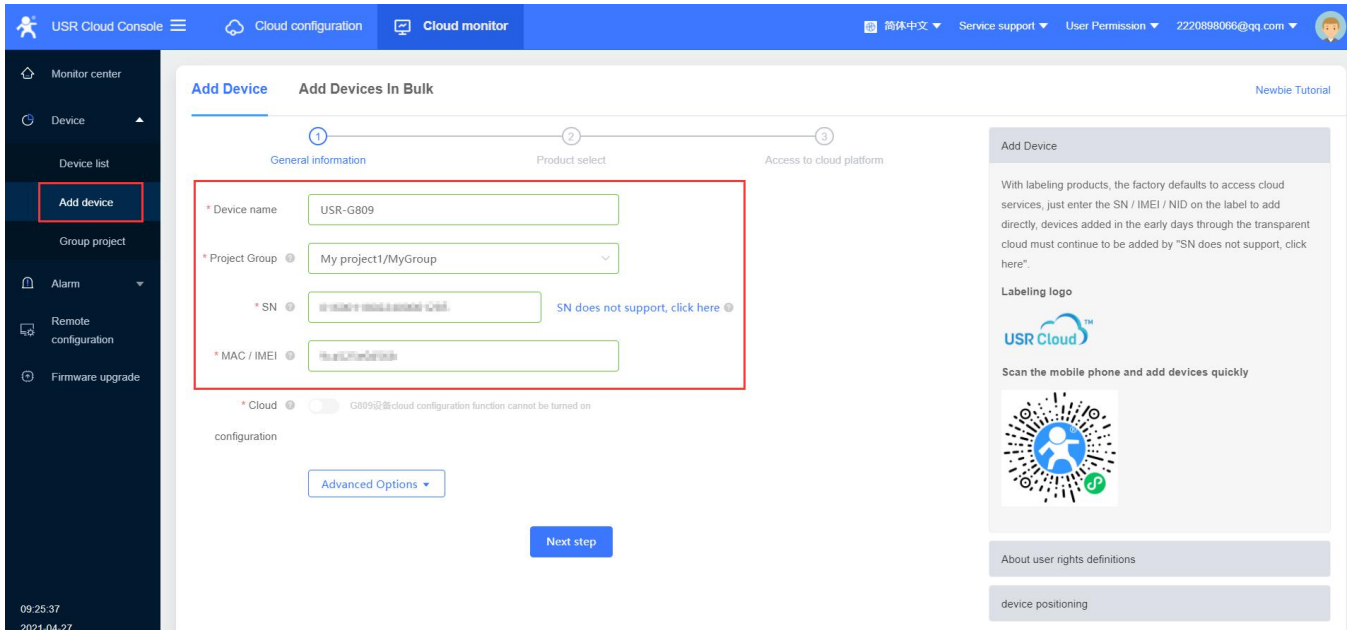

8.3. Network Status

In "Device List", click "View", it will show the network status of the device.

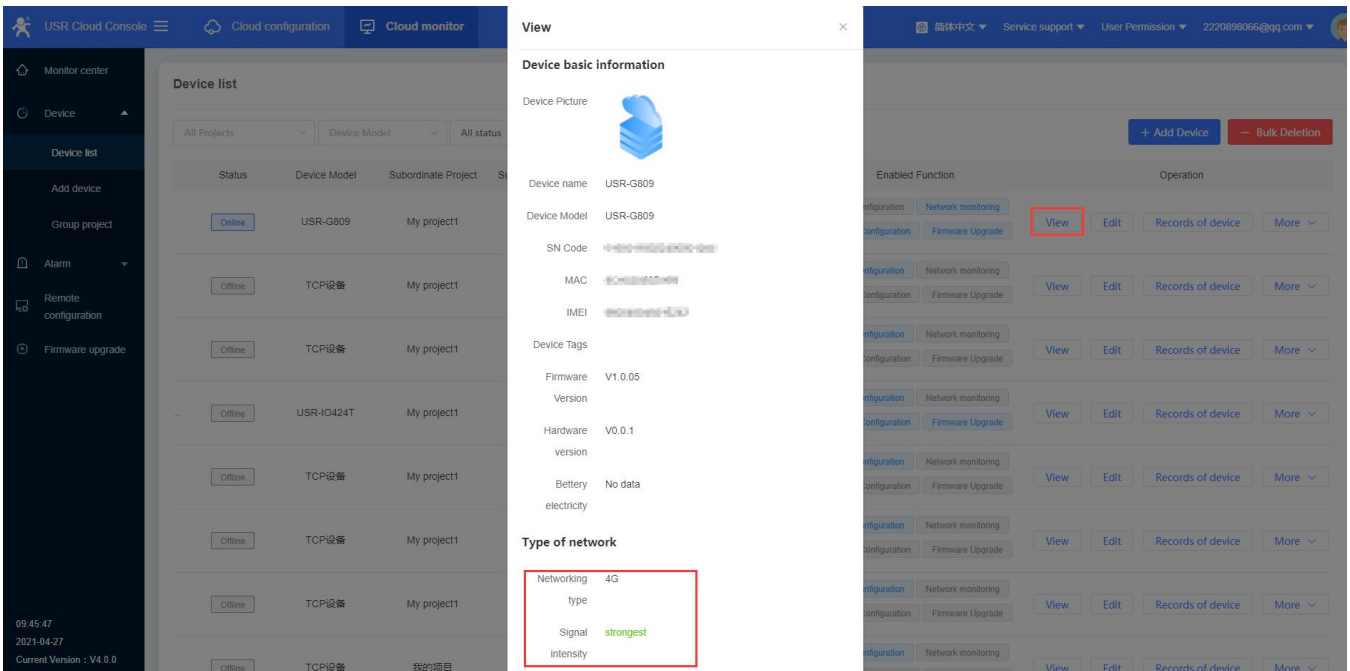

8.4. Parameter Configuration

Users can configure the device parameters via AT commands from USR Cloud.

1. In “Cloud monitor---Device list--More”, click “Parameter configuration”.

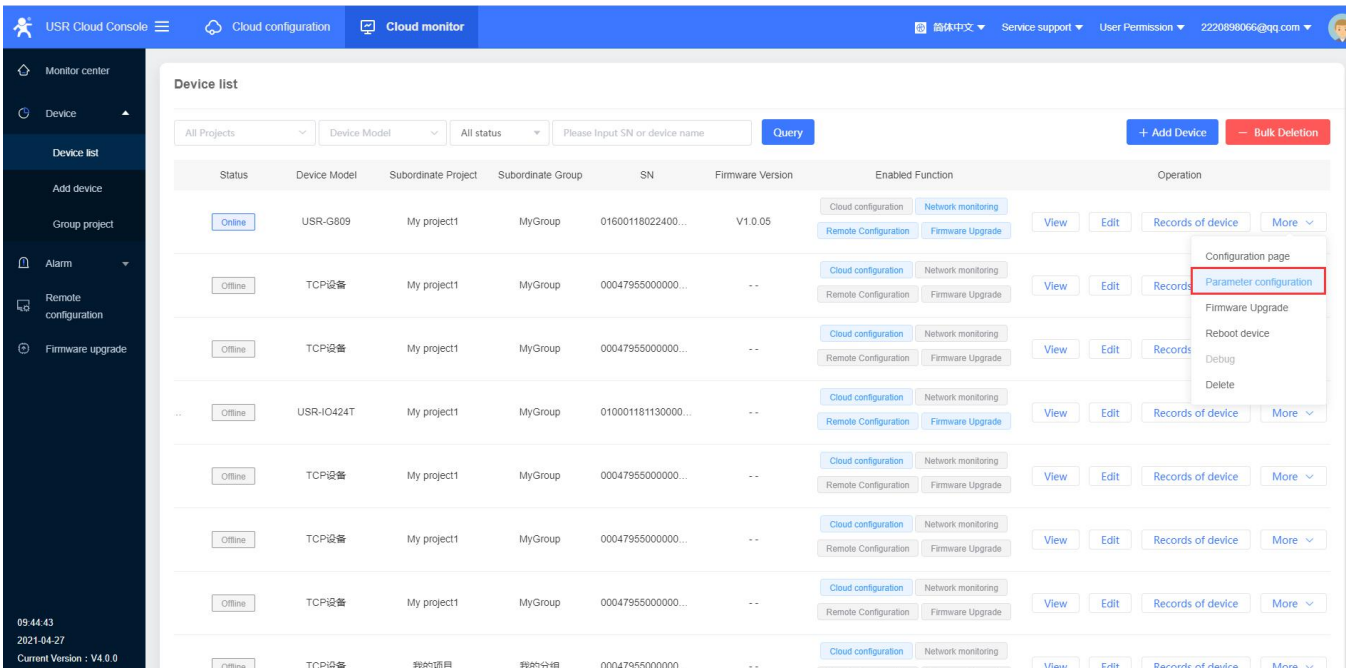

2. Can send AT commands to query or configure the device parameters via AT commands.

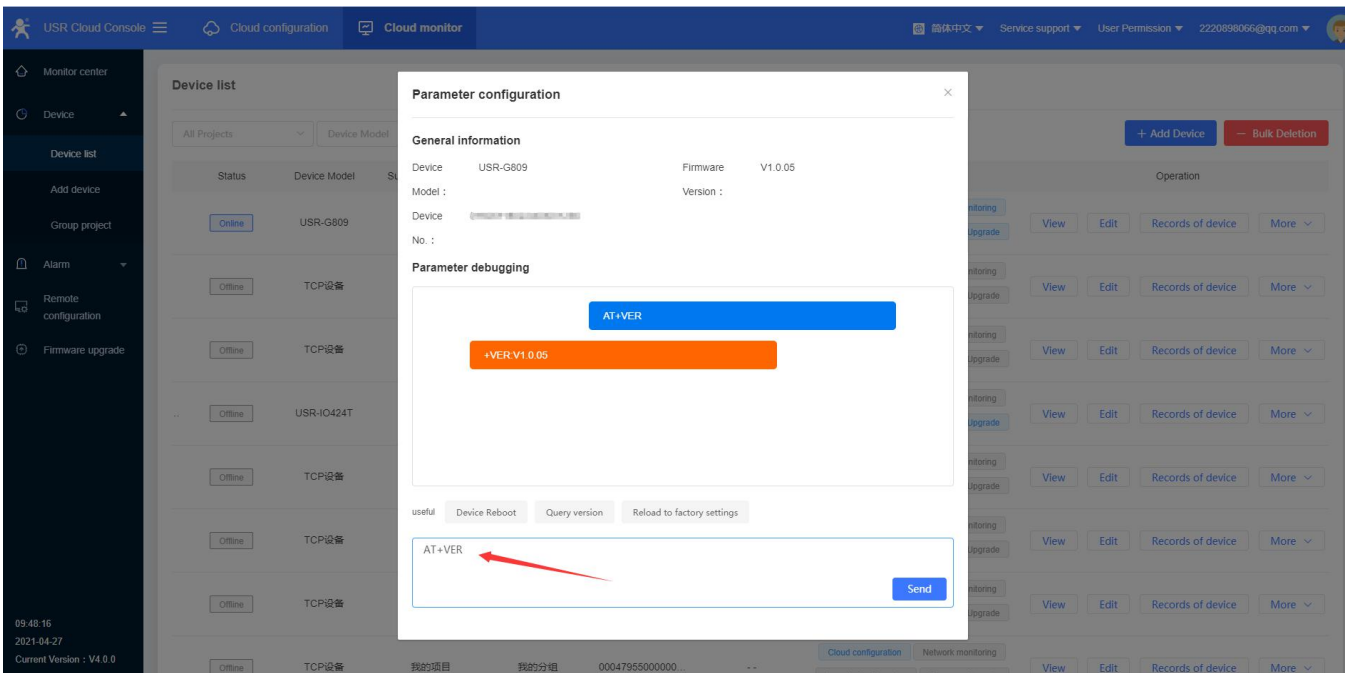

8.5. Firmware Upgrade

USR-G809 supports upgrading firmware via USR Cloud.

1. In "Device list---More", click "Firmware Upgrade".

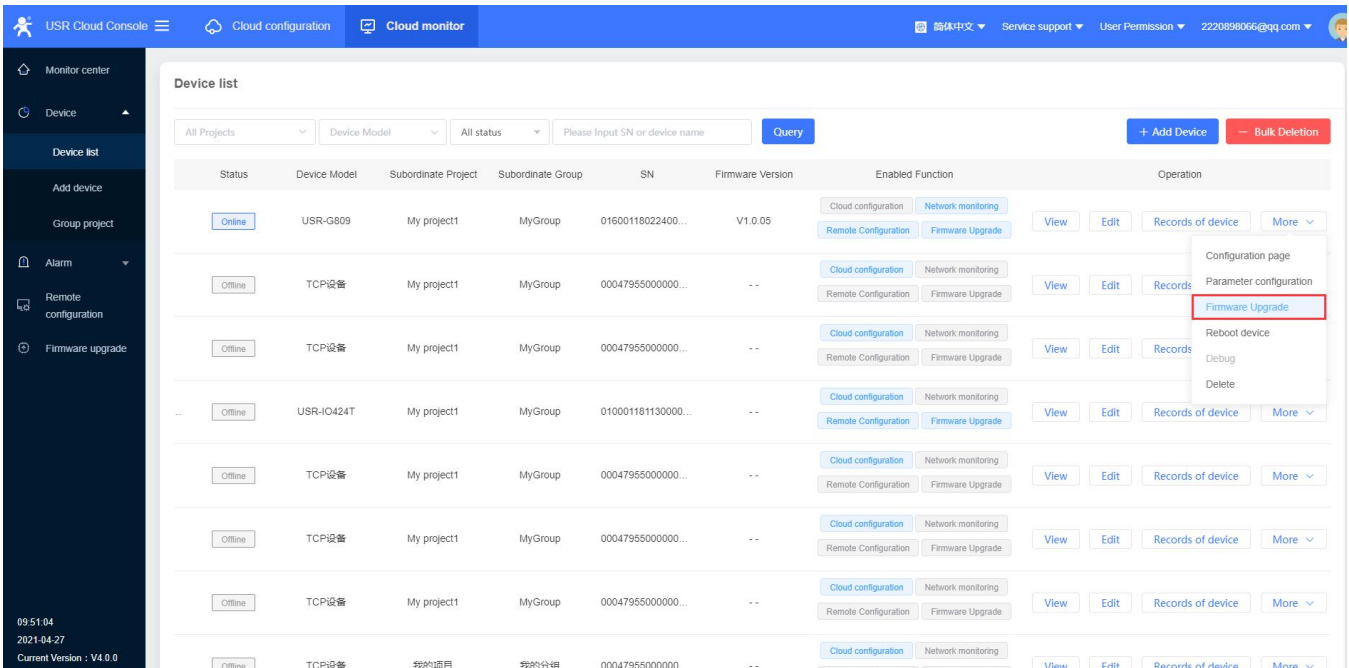

Or can directly click "Firmware Upgrade" under "Cloud Monitor", then click "Add upgrade task".

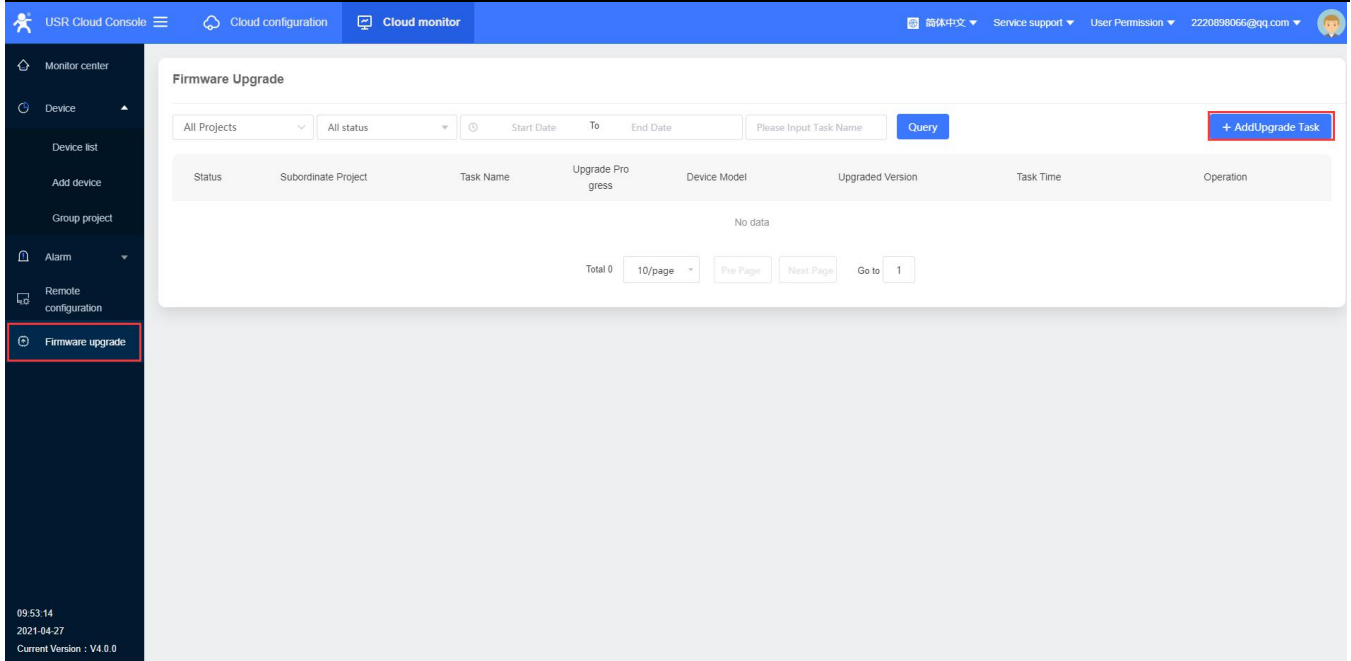

2. Fill in the task name, device model, firmware version, task name, then click “Save”.

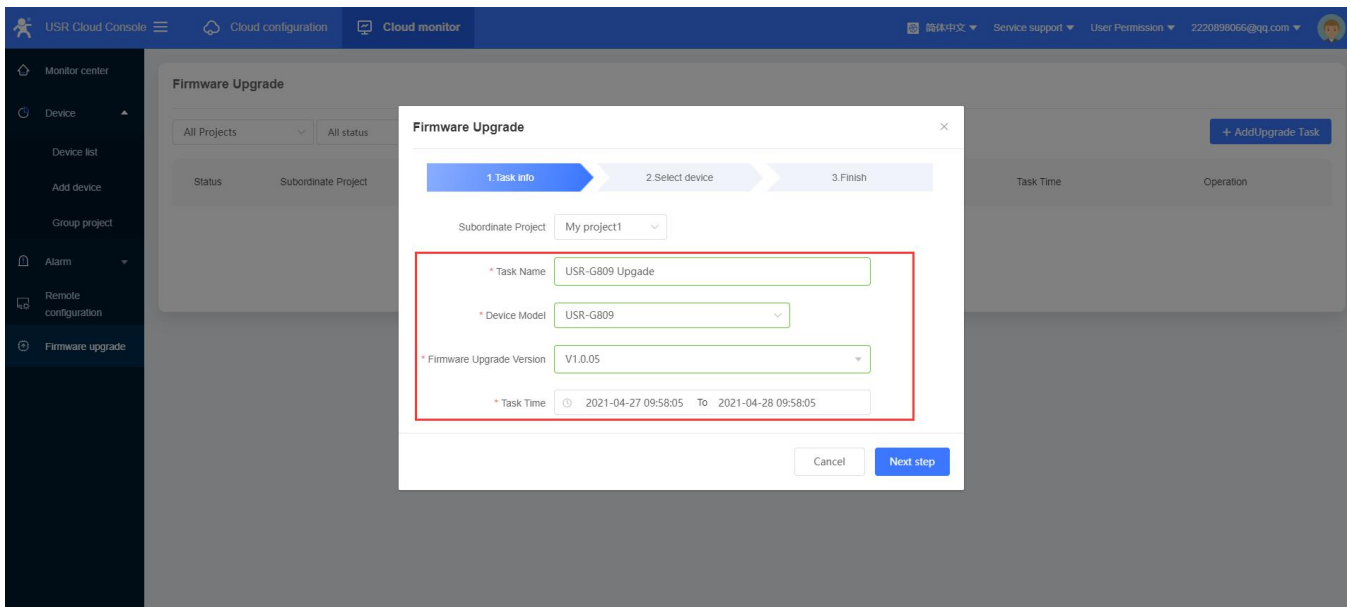

3. You can also check the current firmware upgrade progress in “Upgrade Details”.

8.6. Records of device

USR Cloud can record all the status information during the operation of the device, including configuration records, update records, signal strength and so on.

In “Cloud monitor--Device List”, click “Records of device”.

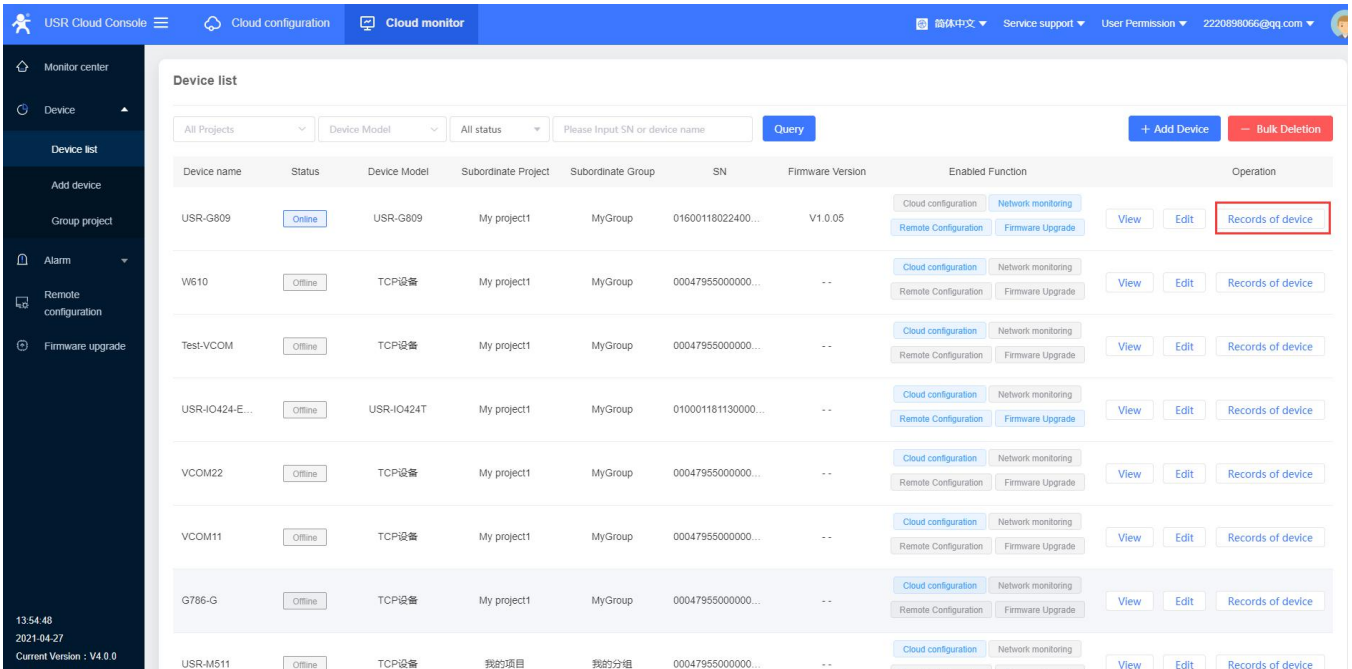

Device list

All Projects | Device Model | All status | Please Input SN or device name | Query | + Add Device | - Bulk Deletion

Device name	Status	Device Model	Subordinate Project	Subordinate Group	SN	Firmware Version	Enabled Function	Operation
USR-G809	Online	USR-G809	My project1	MyGroup	01600118022400...	V1.0.05	Cloud configuration, Network monitoring, Remote Configuration, Firmware Upgrade	View, Edit, Records of device
W610	Offline	TCP设备	My project1	MyGroup	00047955000000...	--	Cloud configuration, Network monitoring, Remote Configuration, Firmware Upgrade	View, Edit, Records of device
Test-VCOM	Offline	TCP设备	My project1	MyGroup	00047955000000...	--	Cloud configuration, Network monitoring, Remote Configuration, Firmware Upgrade	View, Edit, Records of device
USR-IO424-E...	Offline	USR-IO424T	My project1	MyGroup	010001181130000...	--	Cloud configuration, Network monitoring, Remote Configuration, Firmware Upgrade	View, Edit, Records of device
VCOM22	Offline	TCP设备	My project1	MyGroup	00047955000000...	--	Cloud configuration, Network monitoring, Remote Configuration, Firmware Upgrade	View, Edit, Records of device
VCOM11	Offline	TCP设备	My project1	MyGroup	00047955000000...	--	Cloud configuration, Network monitoring, Remote Configuration, Firmware Upgrade	View, Edit, Records of device
G786-G	Offline	TCP设备	My project1	MyGroup	00047955000000...	--	Cloud configuration, Network monitoring, Remote Configuration, Firmware Upgrade	View, Edit, Records of device
USR-M511	Offline	TCP设备	我的项目	我的分组	00047955000000...	--	Cloud configuration, Network monitoring	View, Edit, Records of device

13:54:48
2021-04-27
Current Version : V4.0.0

You can check the traffic curve, signal strength curve under “Device Monitoring”.

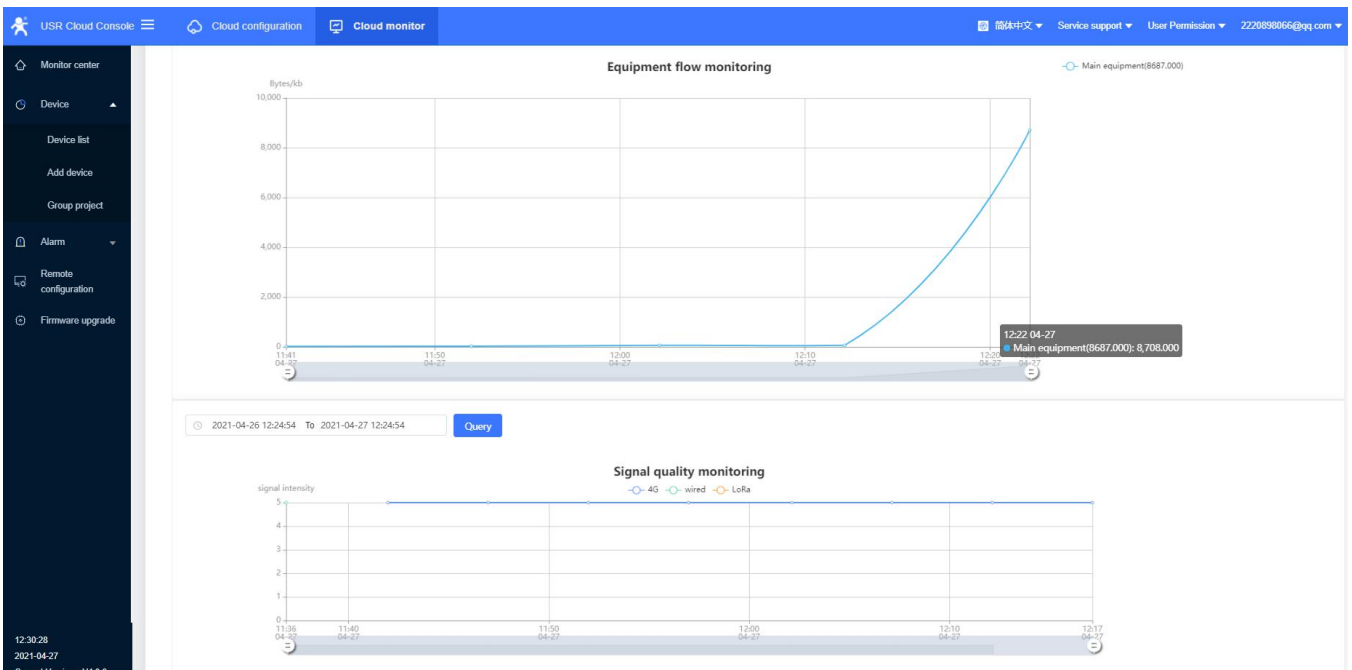

Equipment flow monitoring

Bytes/kb

10,000
8,000
6,000
4,000
2,000
0

11:41 04-27 | 11:50 04-27 | 12:00 04-27 | 12:10 04-27 | 12:20 04-27 | 12:22 04-27

12:22 04-27
Main equipment(8687.000): 8,708.000

2021-04-26 12:24:54 To 2021-04-27 12:24:54 | Query

Signal quality monitoring

signal intensity

5
4
3
2
1
0

11:38 04-27 | 11:40 04-27 | 11:50 04-27 | 12:00 04-27 | 12:10 04-27 | 12:17 04-27

Legend: 4G, wired, LoRa

Online Record:

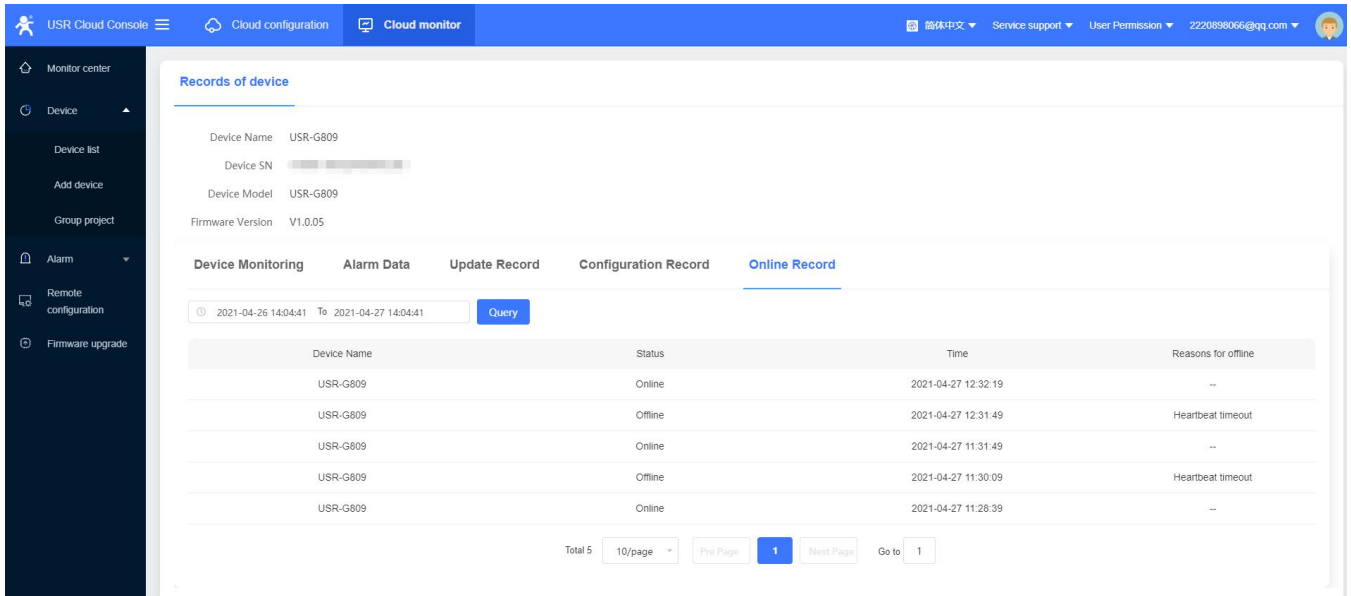

The screenshot shows the 'Records of device' page in the USR Cloud Console. The device name is USR-G809. The page has tabs for 'Device Monitoring', 'Alarm Data', 'Update Record', 'Configuration Record', and 'Online Record'. A date range filter is set to '2021-04-26 14:04:41' to '2021-04-27 14:04:41'. A table displays the following records:

Device Name	Status	Time	Reasons for offline
USR-G809	Online	2021-04-27 12:32:19	--
USR-G809	Offline	2021-04-27 12:31:49	Heartbeat timeout
USR-G809	Online	2021-04-27 11:31:49	--
USR-G809	Offline	2021-04-27 11:30:09	Heartbeat timeout
USR-G809	Online	2021-04-27 11:28:39	--

Page navigation shows 'Total 5', '10/page', 'Pre Page', '1', 'Next Page', and 'Go to 1'.

8.7. Alarm

USR Cloud can achieve alarm via device status, like device offline, weak signal strength, traffic consumption exceeds the set value.

1. Add the alarm contacts in "Cloud Monitor--Alarm contacts".

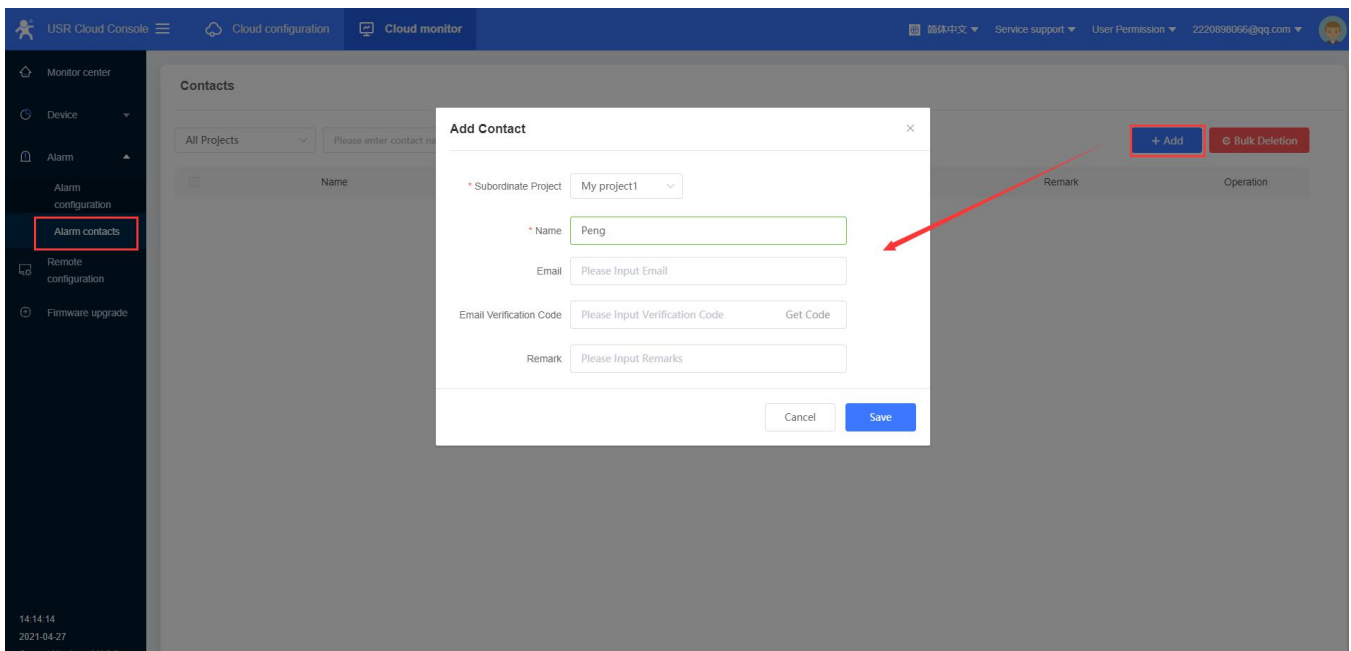

The screenshot shows the 'Contacts' page in the USR Cloud Console. The 'Alarm contacts' link in the left sidebar is highlighted with a red box. An 'Add Contact' dialog box is open, with a red arrow pointing to the 'Name' field. The dialog contains the following fields:

- * Subordinate Project: My project1
- * Name: Peng
- Email: Please Input Email
- Email Verification Code: Please Input Verification Code (with a 'Get Code' button)
- Remark: Please Input Remarks

Buttons for 'Cancel' and 'Save' are at the bottom of the dialog. In the background, there are '+ Add' and 'Bulk Deletion' buttons.

2. Add alarm configuration in "Device monitor--Alarm configuration". Here we can set the alarm rules to "Offline time of device >5min", push it via email.

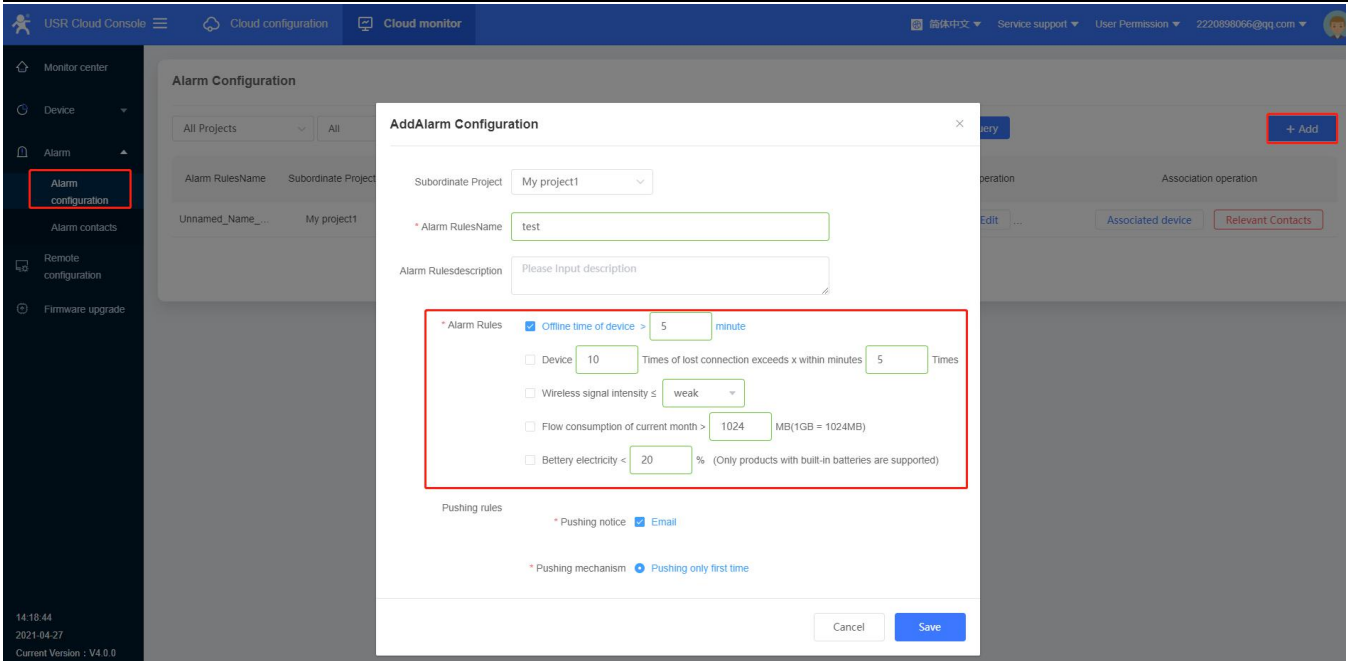

3. Add the associated device, then click “Save”.

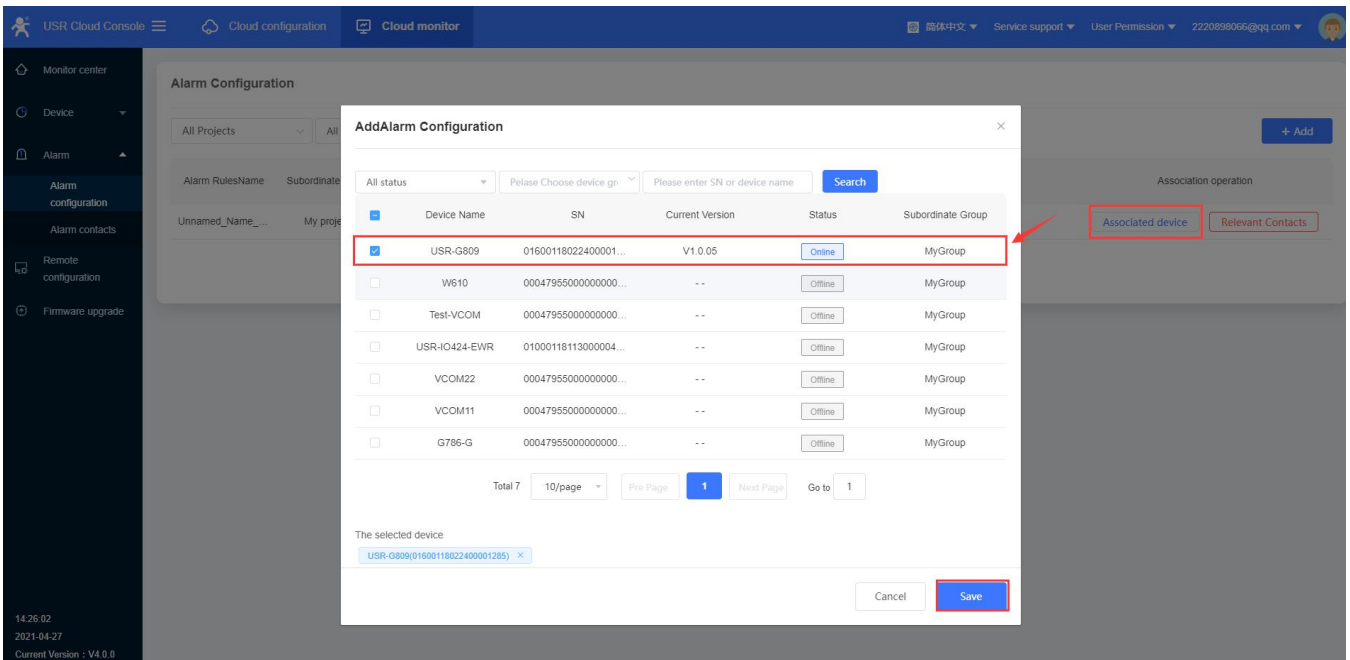

4. Add the relevant contacts.

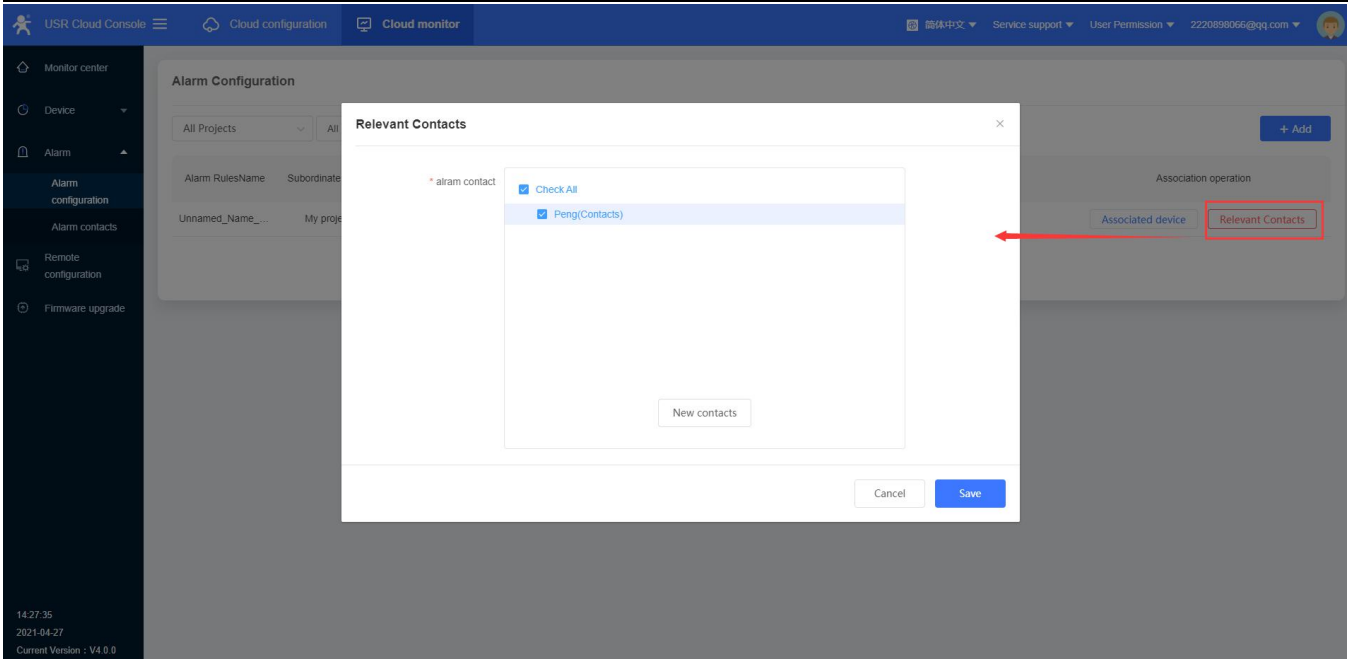

5. Power off the device, we will receive the alarm email from USR Cloud.

8.8. Remote Configuration

8.8.1. Configure via AT Commands

USR-G809 supports remote configuration via AT commands.

1. Add tasks in "Remote Configuration". Set the device model to "USR-G809".

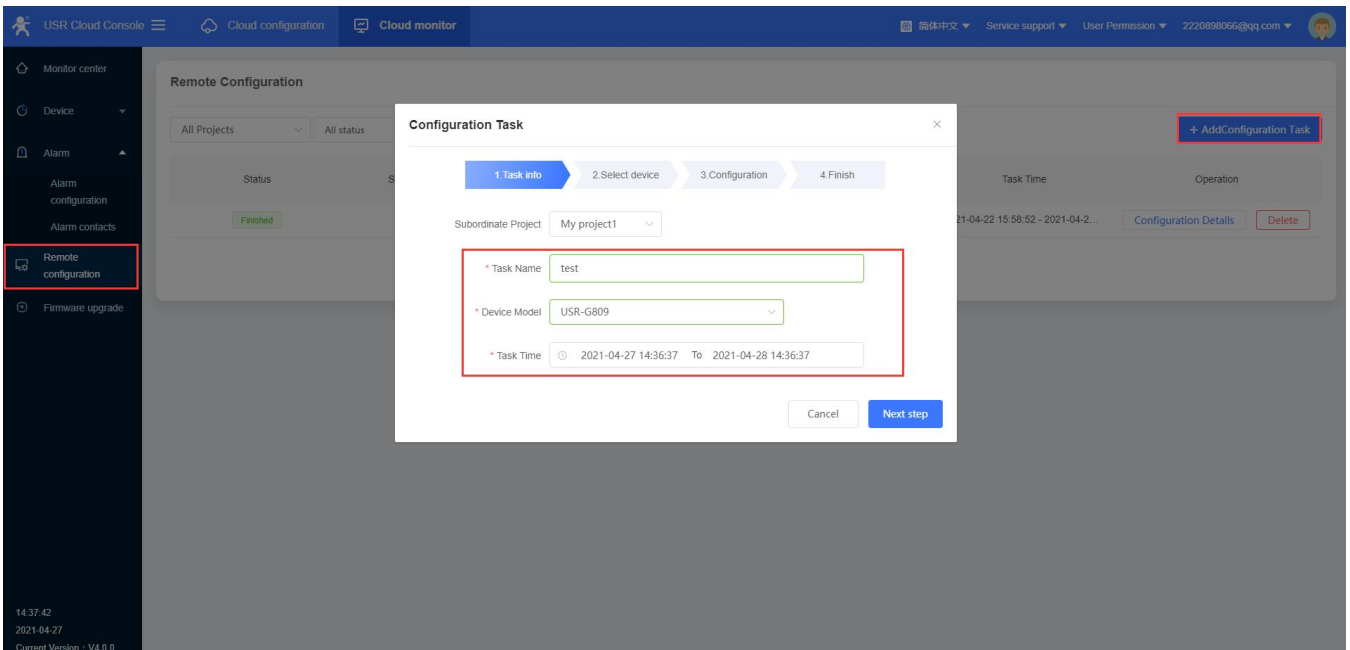

2. Click "Next step", it will show all the devices with this model.

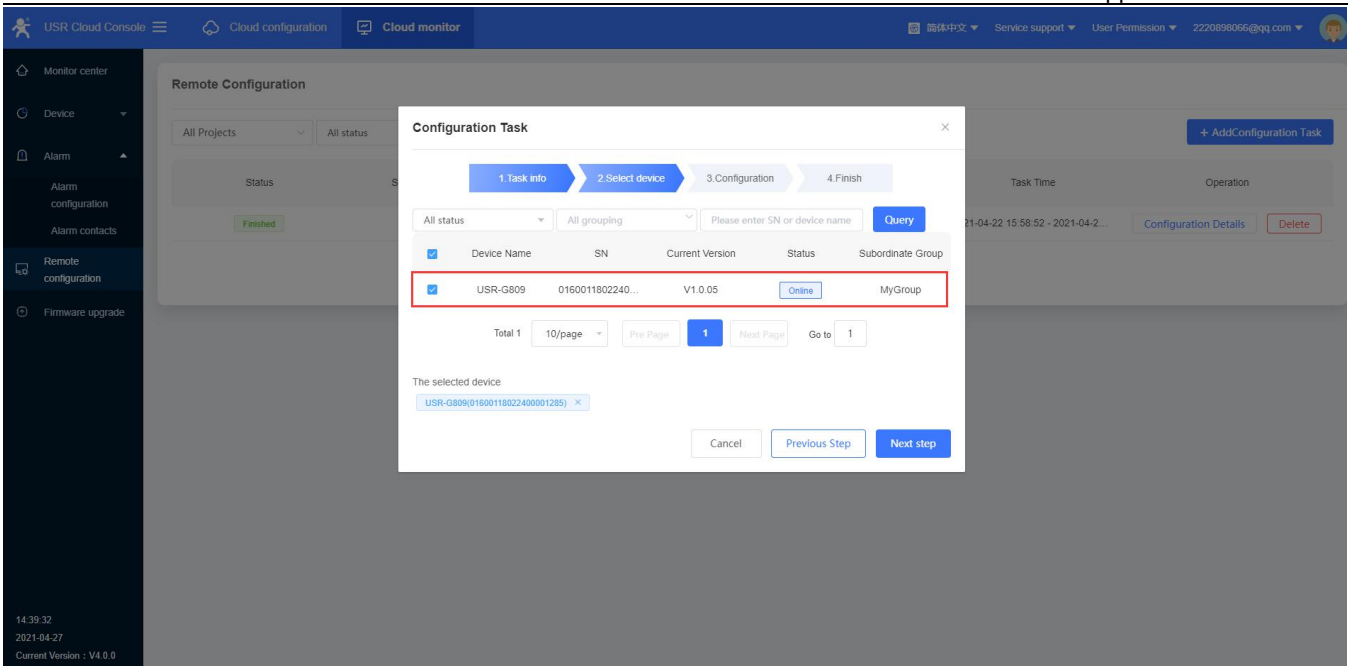

3. Add the commands to tasks, then click “Save”.

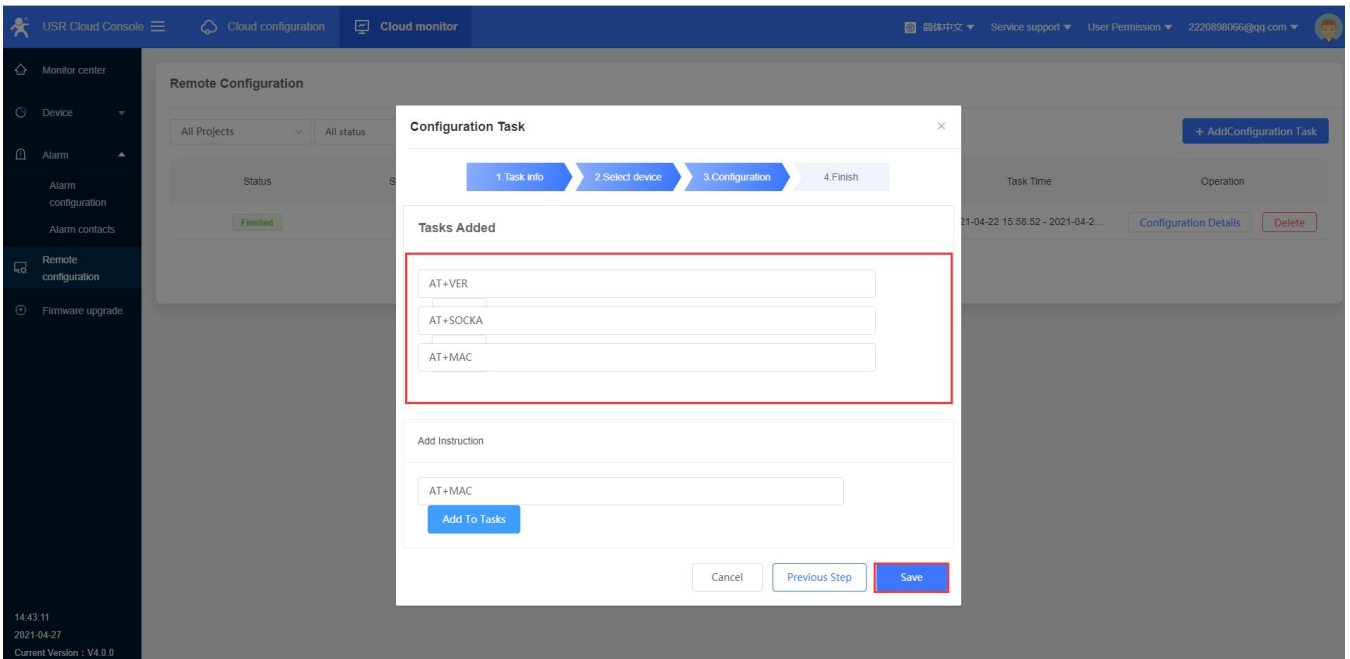

4. We can check the logs in “Configuration Details”.

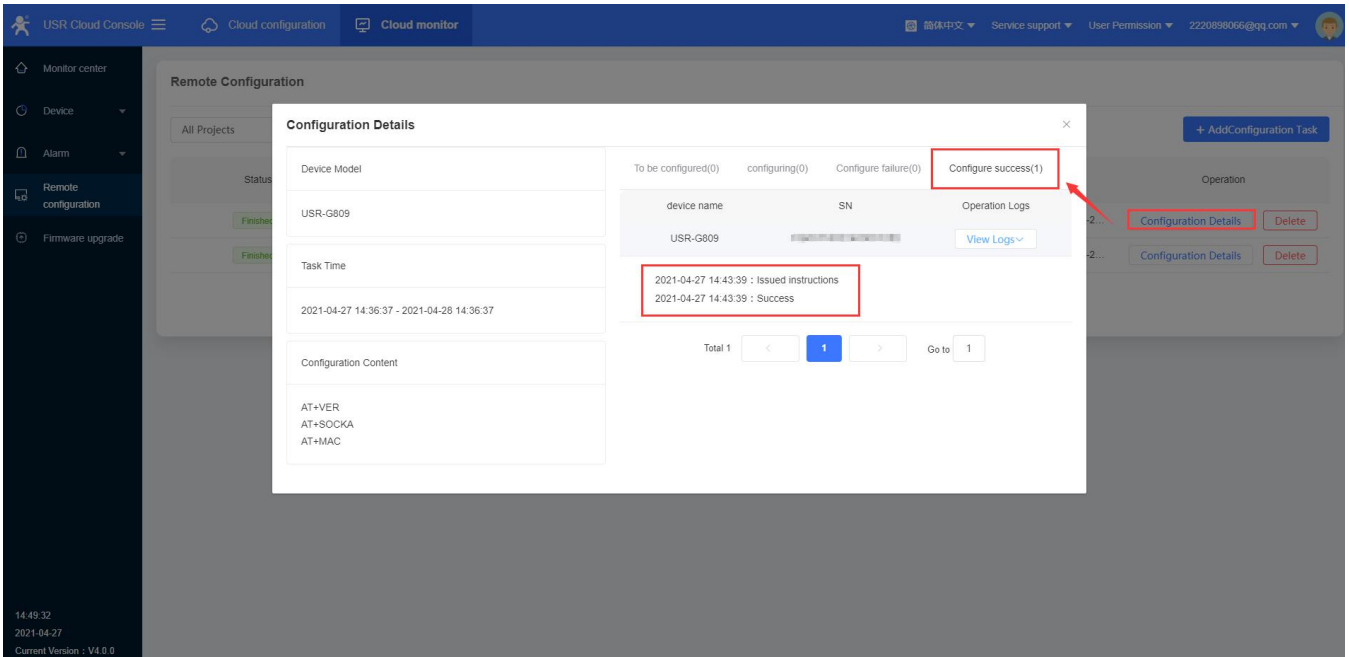

8.8.2. Configure via Webpage

Users can log into G809's webpage to configure the device via USR Cloud.

In "Device Monitor--Device list", click "More", select "Configuration page".

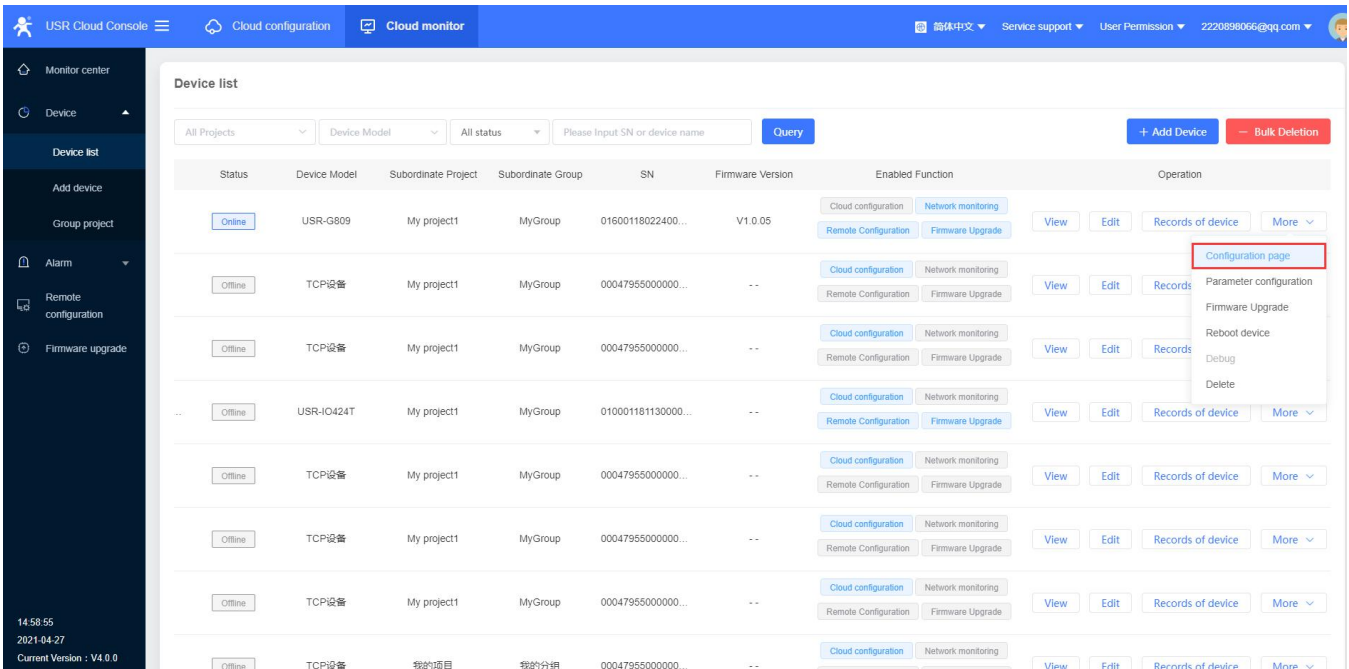

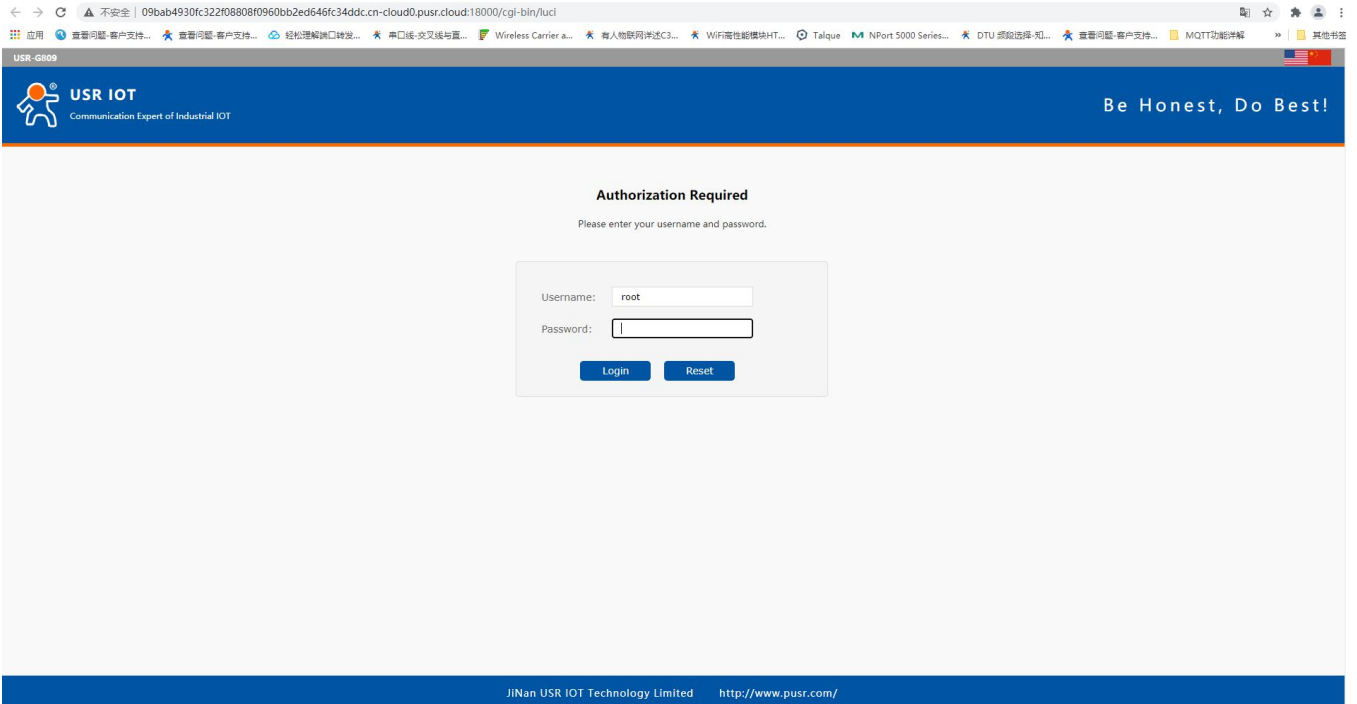

9. Services

9.1. Syslog

9.1.1. Remote Log

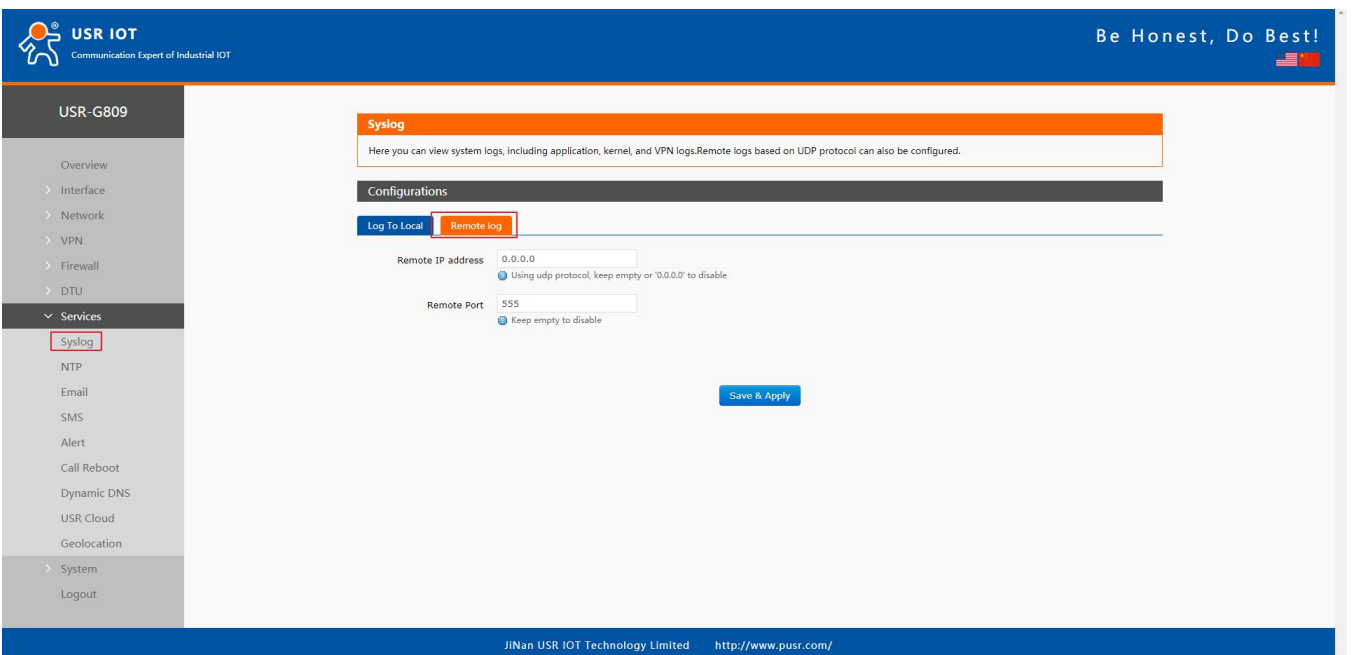

Remote IP address: Remote UDP server IP/domain name, this function is disabled when the IP is 0.0.0.0.

Remote port: Remote UDP server port.

9.1.2. Local Log

We can view and download the router logs in below interface.

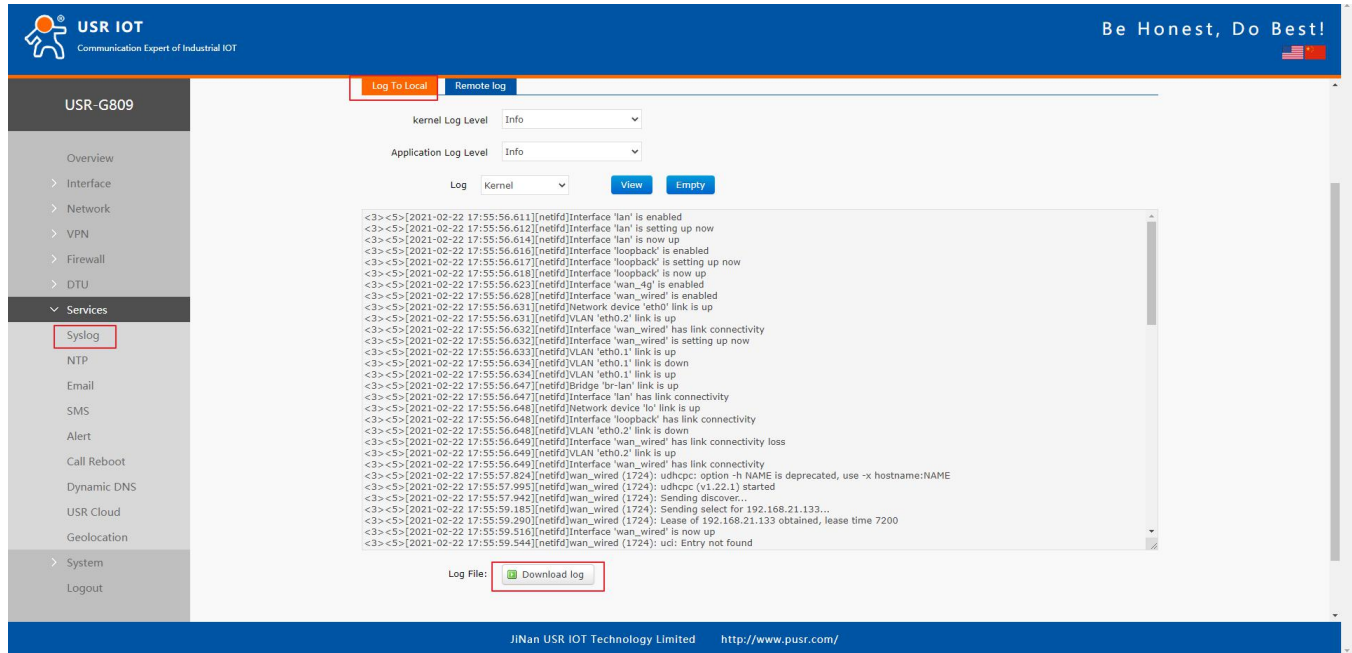

The screenshot shows the 'Syslog' configuration page for the USR-G809 router. The 'Log To Local' tab is selected. The 'kernel Log Level' and 'Application Log Level' are both set to 'Info'. The 'Log' dropdown is set to 'Kernel'. A 'View' button is visible. Below, a scrollable list of log entries is displayed, including messages like 'interface 'lan' is enabled', 'interface 'wan_wired' is enabled', and 'interface 'wan_wired' has link connectivity'. A 'Download log' button is located at the bottom of the log list.

9.2. NTP

NTP client function is enabled by default, user can also set the NTP server addresses.

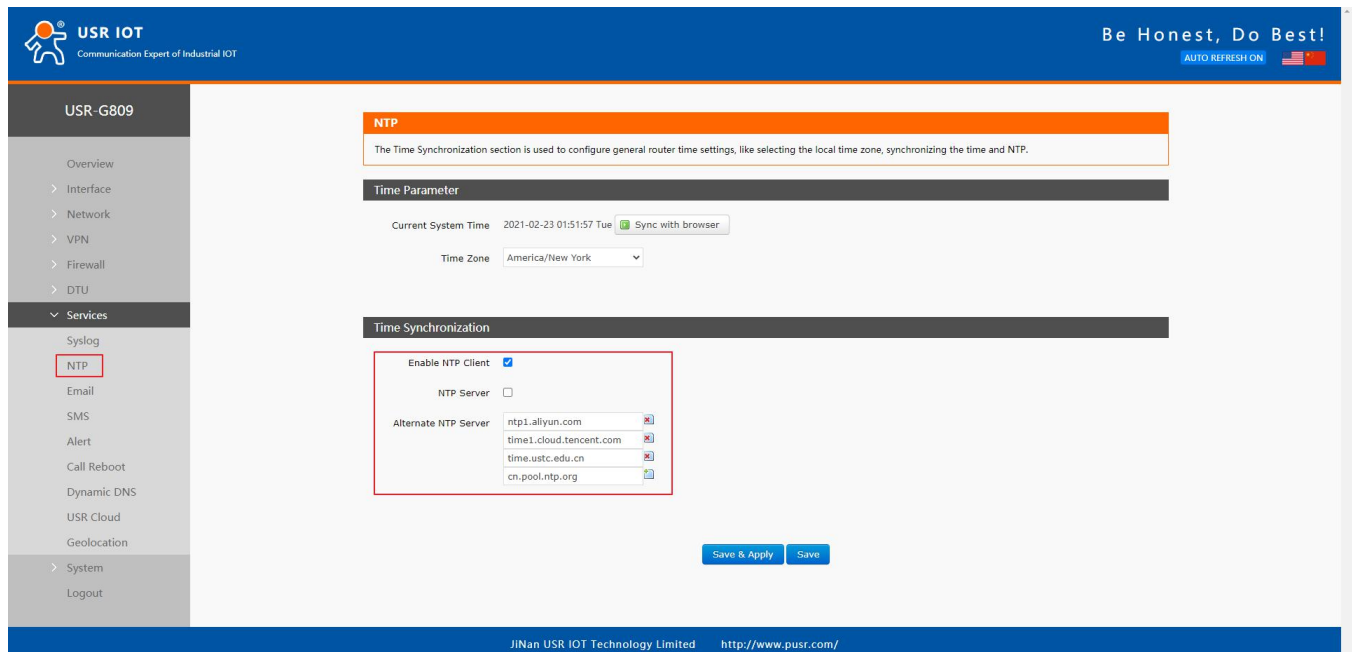

The screenshot shows the 'NTP' configuration page. The 'Enable NTP Client' checkbox is checked. Under 'NTP Server', there is an unchecked checkbox. Under 'Alternate NTP Server', three servers are listed: 'ntp1.aliyun.com', 'time1.cloud.tencent.com', and 'time.ustc.edu.cn'. A fourth server, 'cn.pool.ntp.org', is also listed. 'Save & Apply' and 'Save' buttons are at the bottom.

Click "Sync with browser" to synchronize the time of the browser.

Change the time zone:

9.3. Email

After connecting to the network, this mailbox will be used as the sender to send a specific alarm email to the set email address.

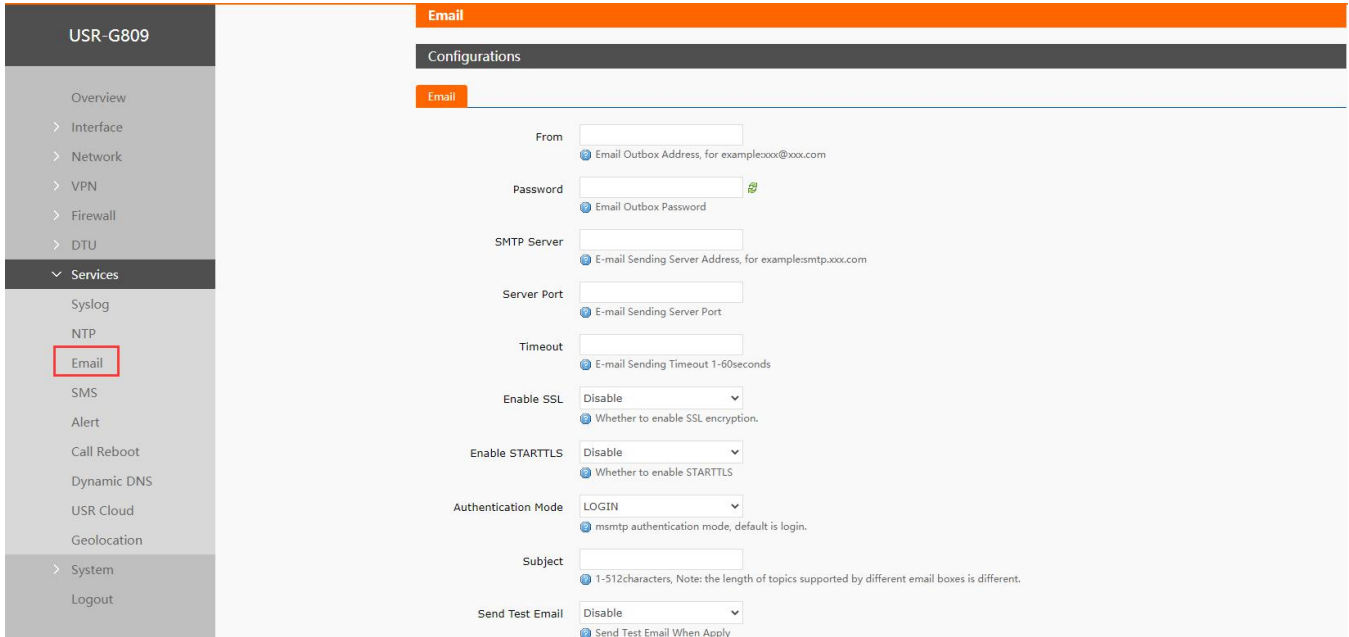

The screenshot shows the 'Email' configuration page in the USR-G809 web interface. The left sidebar lists various services, with 'Email' selected. The main configuration area includes the following fields:

- From:** Text input field with a tooltip: "Email Outbox Address, for example:xxx@xxx.com"
- Password:** Text input field with a tooltip: "Email Outbox Password"
- SMTP Server:** Text input field with a tooltip: "E-mail Sending Server Address, for example:smtp.xxx.com"
- Server Port:** Text input field with a tooltip: "E-mail Sending Server Port"
- Timeout:** Text input field with a tooltip: "E-mail Sending Timeout 1-60seconds"
- Enable SSL:** Dropdown menu set to "Disable" with a tooltip: "Whether to enable SSL encryption."
- Enable STARTTLS:** Dropdown menu set to "Disable" with a tooltip: "Whether to enable STARTTLS"
- Authentication Mode:** Dropdown menu set to "LOGIN" with a tooltip: "msmtp authentication mode, default is login."
- Subject:** Text input field with a tooltip: "1-512characters, Note: the length of topics supported by different email boxes is different."
- Send Test Email:** Dropdown menu set to "Disable" with a tooltip: "Send Test Email When Apply"

Item	Description	Default
From	Sender mail of the alarm	None
Password	Sender mail password or the set third party mailbox authorization code	None
SMTP server	Outgoing mail server. Can check in "Set--Client Settings" of the mail.	None
Server port	Outgoing mail server port. Can check in "Set--Client Settings" of the mail.	None
Timeout(Units: s)	Email sending timeout: 1~60s	None
Enable SSL	Whether to enable SSL encryption. Can check in "Set--Client Settings" of the mail.	Disable
Enable STARTTLS	Whether to enable STARTTLS.	Disable
Authentication Mode	LOGIN/PLAIN/Custom	LOGIN
Subject	Subject when sending the email.	None
Send test email	Whether to enable sending test email	Disable

Note:

1. If fails to send the email with the correct configuration, please check if the authorization code is needed. The authorization code is a special password used by the third party to log in the mail client.
2. Outlook and Tencent Exmail have been validated for this function.

9.4. SMS

This function is just for SMS test. Please waiting 2~15s after clicking “Test SMS”.

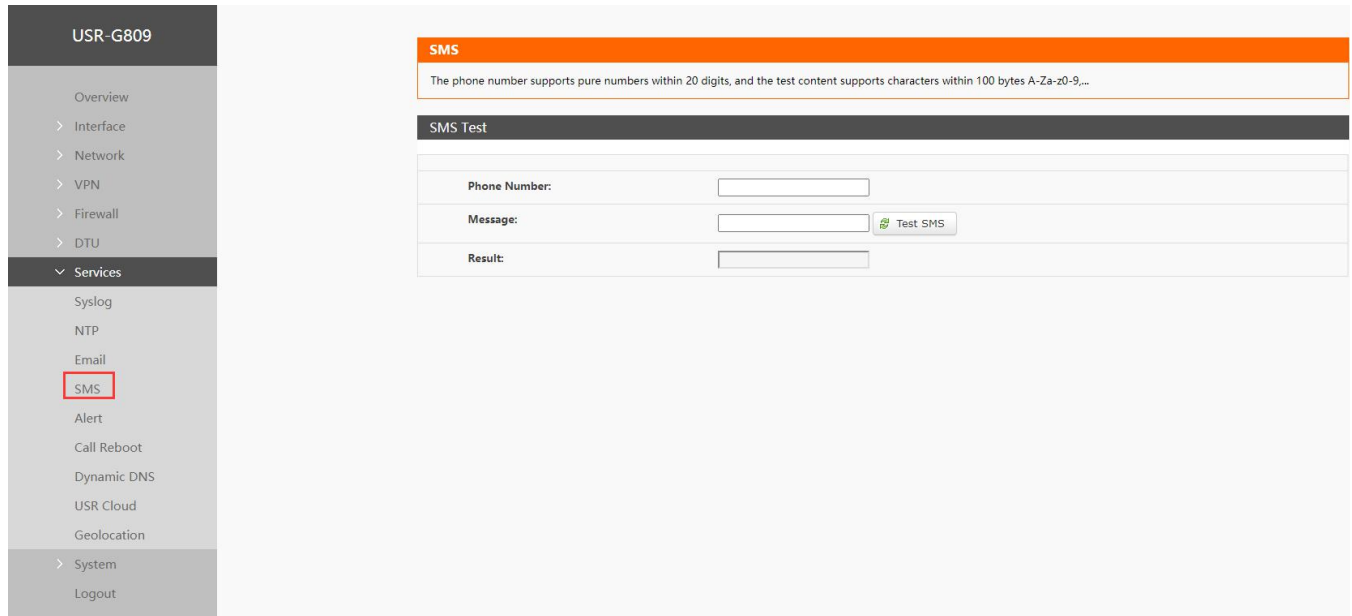

The screenshot shows the USR-G809 web interface. On the left is a navigation menu with 'Services' expanded and 'SMS' selected. The main content area has an orange header for 'SMS' with a note: 'The phone number supports pure numbers within 20 digits, and the test content supports characters within 100 bytes A-Za-z0-9,...'. Below this is the 'SMS Test' form with three input fields: 'Phone Number', 'Message', and 'Result'. A 'Test SMS' button is located next to the 'Message' field.

Item	Description	Default
Phone number	Send SMS to this phone number	None
Message	SMS content	None
Result	Success or Fail	-

9.5. Alert

G809 supports alerting via SMS, Email and triggering DO, supports carrying device information. It supports up to 20 alert messages with many different device status.

USR-G809

- Overview
- > Interface
- > Network
- > VPN
- > Firewall
- > DTU
- > Services
- Syslog
- NTP
- Email
- SMS
- Alert
- Call Reboot
- Dynamic DNS
- USR Cloud
- Geolocation
- > System
- Logout

Alert - Events Notification - index("1")

Note: SMS can be up to 140 bytes long. The content of the SMS is composed of alarm event content + alarm description + alarm time + device information. If the description information filled in is too long, the received SMS may be incomplete.

General Settings
Event Selection

Descriptions

Note: SMS supports up to 140 bytes.

Send SMS

Send Email

DO Control

Device Information

[Back to Overview](#)

USR-G809

- Overview
- > Interface
- > Network
- > VPN
- > Firewall
- > DTU
- > Services
- Syslog
- NTP
- Email
- SMS
- Alert
- Call Reboot
- Dynamic DNS
- USR Cloud
- Geolocation
- > System
- Logout

General Settings
Event Selection

WAN_4G Online

WAN_4G Offline

Network Type Change

WAN Up

WAN Down

System Reboot

DI 1 ON

DI 1 OFF

DI 1 Counter Overflow

DI 2 ON

DI 2 OFF

DI 2 Counter Overflow

Cellular Data Traffic Overflow

[Back to Overview](#)

Item	Description	Default
Description	Alarm content	alarmx
Send SMS	Disable/Enable	Disable
Phone number	Phone number to receive the alarm message	None
Send email	Disable/Enable	Disable
Email address	Email address to receive the alarm message, please set the correct email information in "Email" interface before using it.	None
DO Control	Disable/DO1/DO2	Disable
DO level	Alarm trigger action is "High" or "Low"	High

Device information	Disable/IMEI/SN/MAC/ICCID	Disable
Event	13 event status	Uncheck

Description:

- DO control cannot be used simultaneously with DO function in DI/DO. If only enable DO1 in DI/DO, please select DO2 here.
- SMS supports up to 140 bytes, including the description, event, time and the message. Do not make the description too long to avoid receiving incomplete messages.
- Please ensure the device has connected to the 4G network and the SIM card supports SMS function before sending SMS.
- Please ensure the device has connected to the network before sending email.
- DO alarm is triggered continuously until the next DO is triggered.
- WAN-4G online: Alarm after successful 4G networking.
- WAN-4G offline: Alarm after connecting to the 4G network again.
- Network type change: Alarm when changing the network.
- WAN up: Alarm when connecting to wired network.
- WAN down: Alarm when the wired network disconnect.
- System reboot: Alarm if the device restart without power off.
- DI 1 ON: Valid when DI1 mode is ON-OFF in "DIDO", alarm when DI1 is triggered.
- DI 1 OFF: Valid when DI1 mode is ON-OFF in "DIDO", alarm when DI1 trigger is canceled.
- DI1 counter overflow: Valid when DI1 mode is Counter in "DIDO", alarm when DI1 reaches the threshold value.
- DI 2 ON: Valid when DI2 mode is ON-OFF in "DIDO", alarm when DI2 is triggered.
- DI 2 OFF: Valid when DI2 mode is ON-OFF in "DIDO", alarm when DI2 trigger is canceled.
- DI2 counter overflow: Valid when DI2 mode is Counter in "DIDO", alarm when DI2 reaches the threshold value.
- Cellular data traffic overflow: This function needs the device to be added in USR Cloud, and enable "Data traffic control" in "Cellular Network".

9.6. Alert Examples

9.6.1. Flow Consumption Alarm via Email

- Add the device in USR Cloud, please refer to [Add device](#).

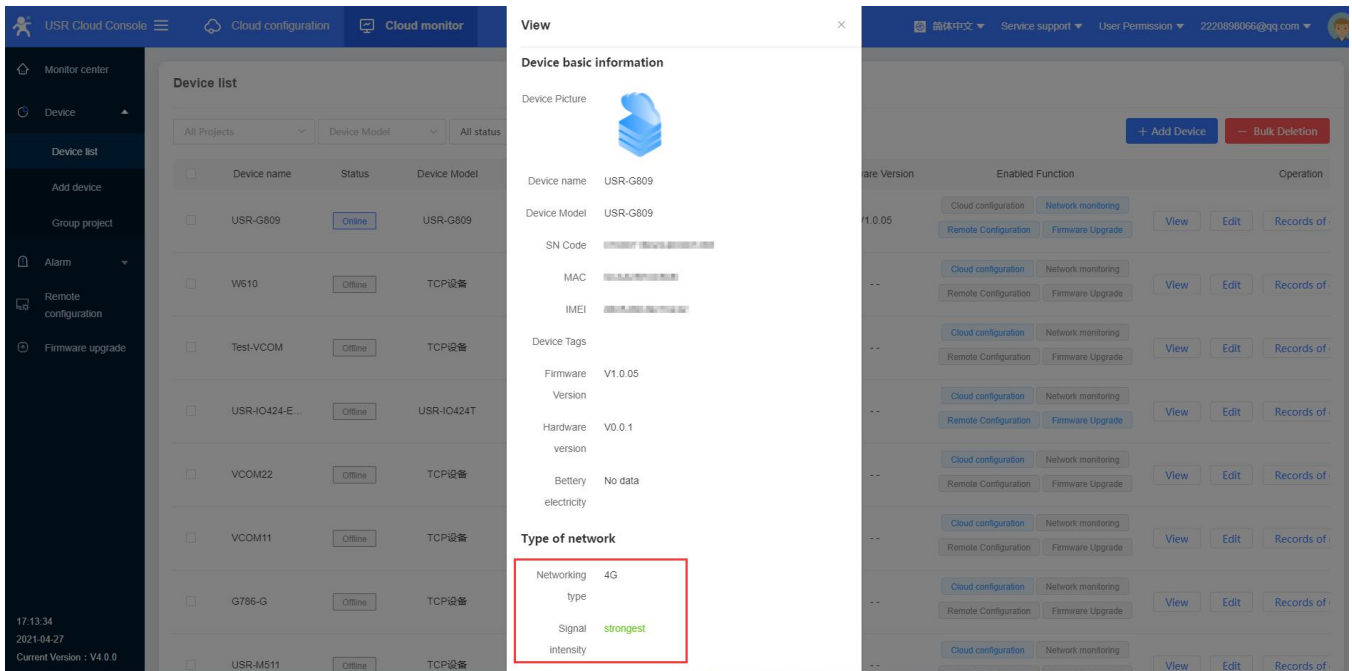

The screenshot shows the 'View' page for a USR-G809 device. The 'Device basic information' section includes fields for Device name, Device Model, SN Code, MAC, and IMEI. The 'Type of network' section is highlighted with a red box and shows the following details:

- Networking type: 4G
- Signal strength: strongest
- intensity

2. Set the traffic limit to 2MB in a month. Save and apply.

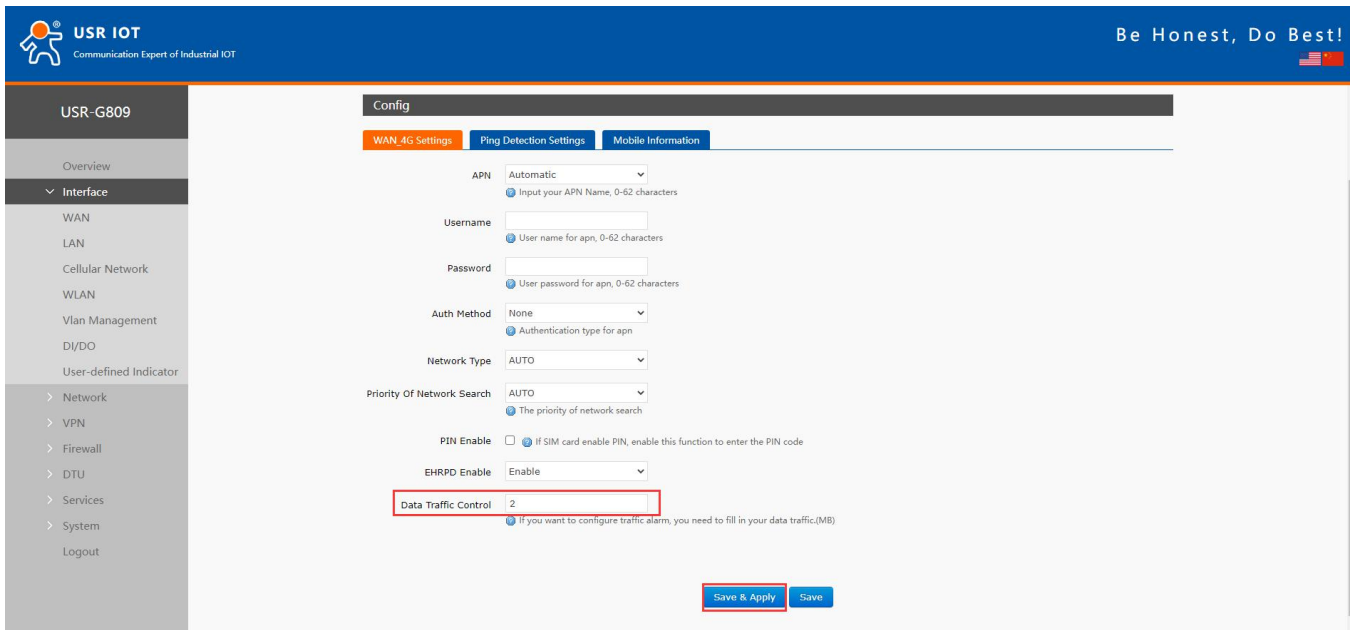

The screenshot shows the 'Config' page for the USR-G809 device. The 'WAN 4G Settings' tab is selected. The 'Data Traffic Control' field is highlighted with a red box and contains the value '2'. Below this field, there is a note: 'If you want to configure traffic alarm, you need to fill in your data traffic.(MB)'. At the bottom of the page, there are 'Save & Apply' and 'Save' buttons.

3. Set the mail information in "Email".

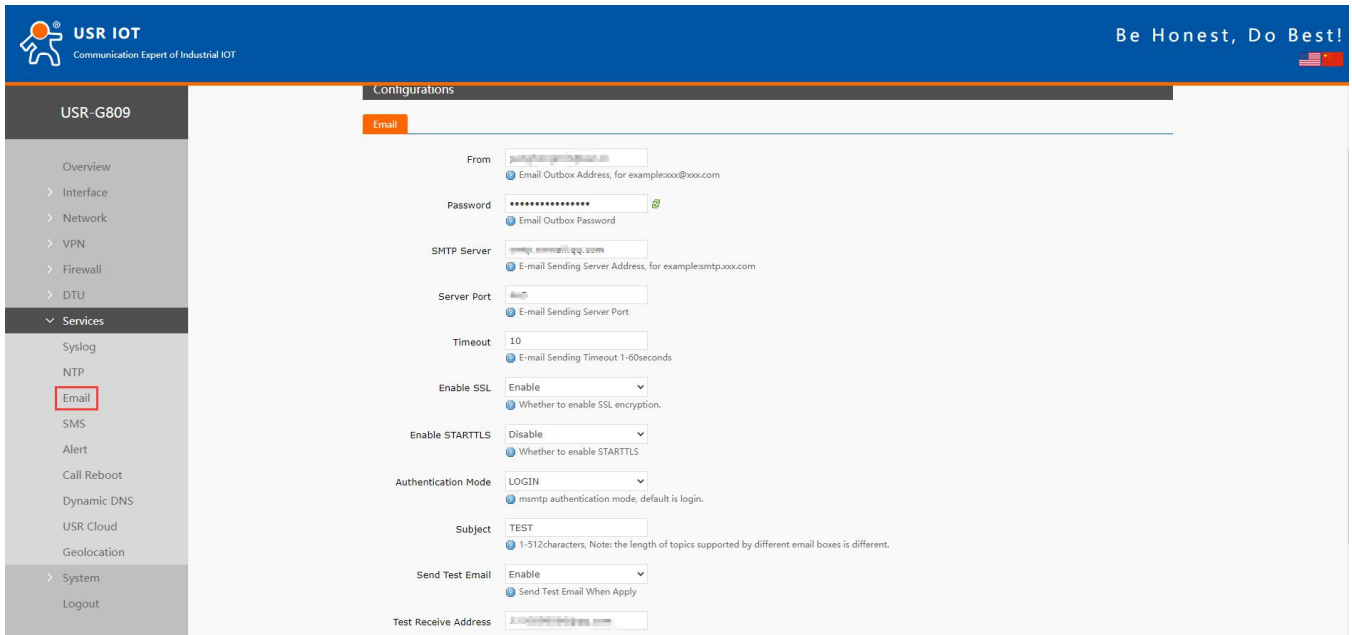

When enable “Send test email”, we can receive the test email.

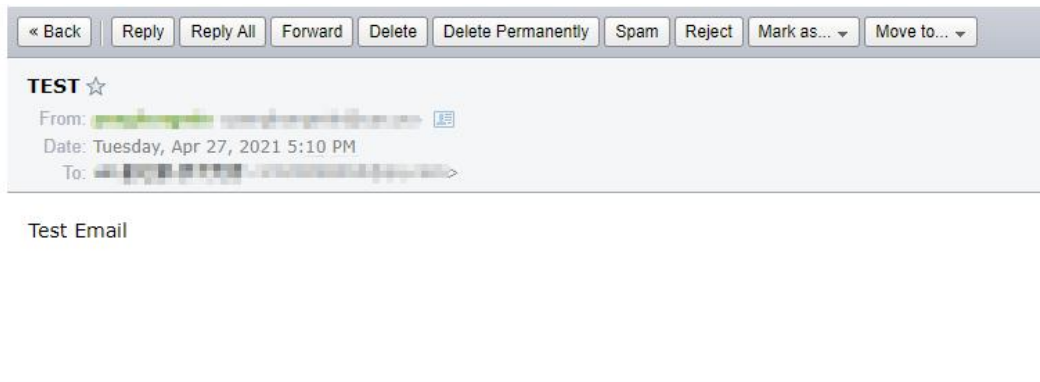

4. Add a alert, enable email alert and carry device SN information. After setting all parameters, click “Save &Apply”.

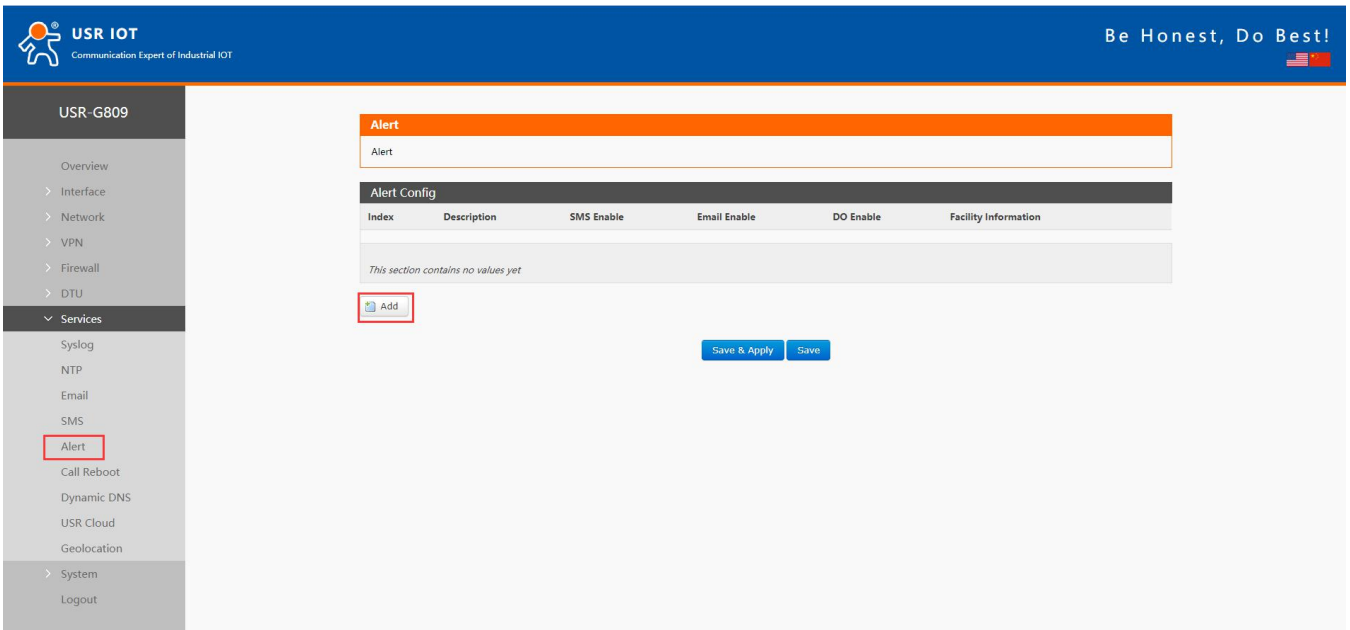

The screenshot shows the USR IOT web interface. The top navigation bar includes the USR IOT logo and the slogan "Be Honest, Do Best!". The left sidebar lists various system settings under "USR-G809", with "Alert" highlighted. The main content area is titled "Alert" and contains an "Alert Config" table. The table has columns for Index, Description, SMS Enable, Email Enable, DO Enable, and Facility Information. Below the table, there is an "Add" button and "Save & Apply" and "Save" buttons.

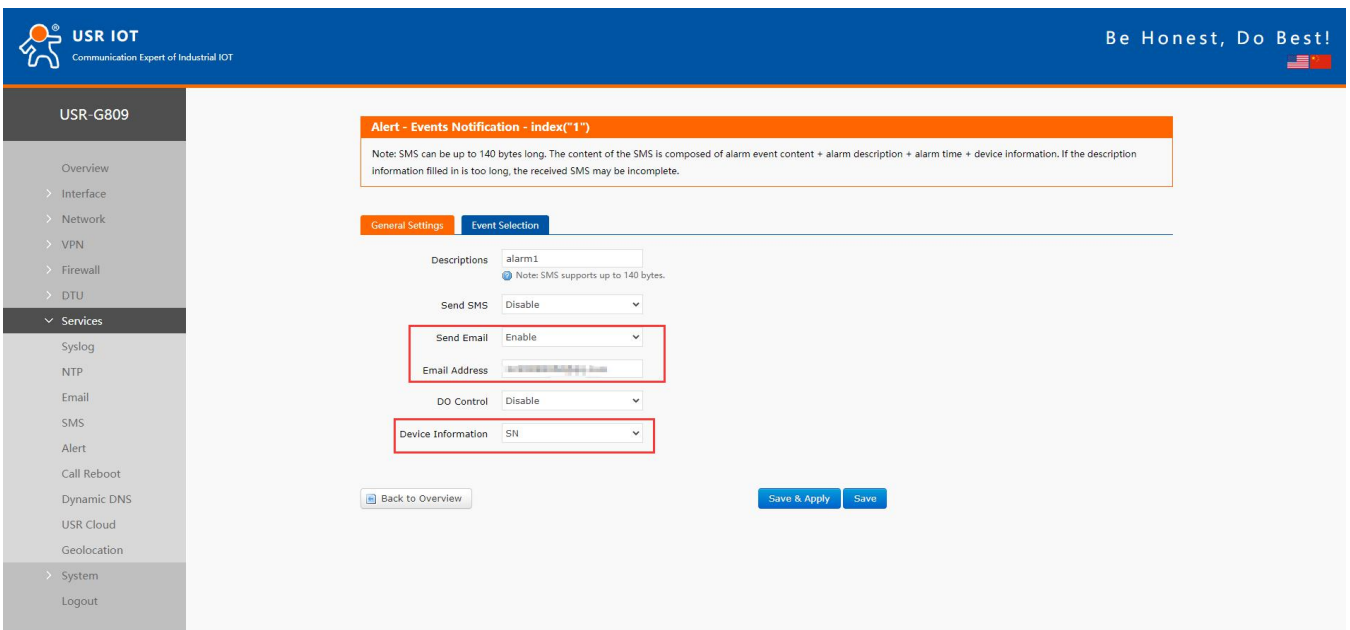

The screenshot shows the "Alert - Events Notification - index('1')" configuration page. It includes a note about SMS length: "Note: SMS can be up to 140 bytes long. The content of the SMS is composed of alarm event content + alarm description + alarm time + device information. If the description information filled in is too long, the received SMS may be incomplete." Below this, there are two tabs: "General Settings" and "Event Selection". Under "Event Selection", there are several configuration options: "Descriptions" (alarm1), "Send SMS" (Disable), "Send Email" (Enable), "Email Address" (a masked email address), "OO Control" (Disable), and "Device Information" (SN). There are "Back to Overview", "Save & Apply", and "Save" buttons at the bottom.

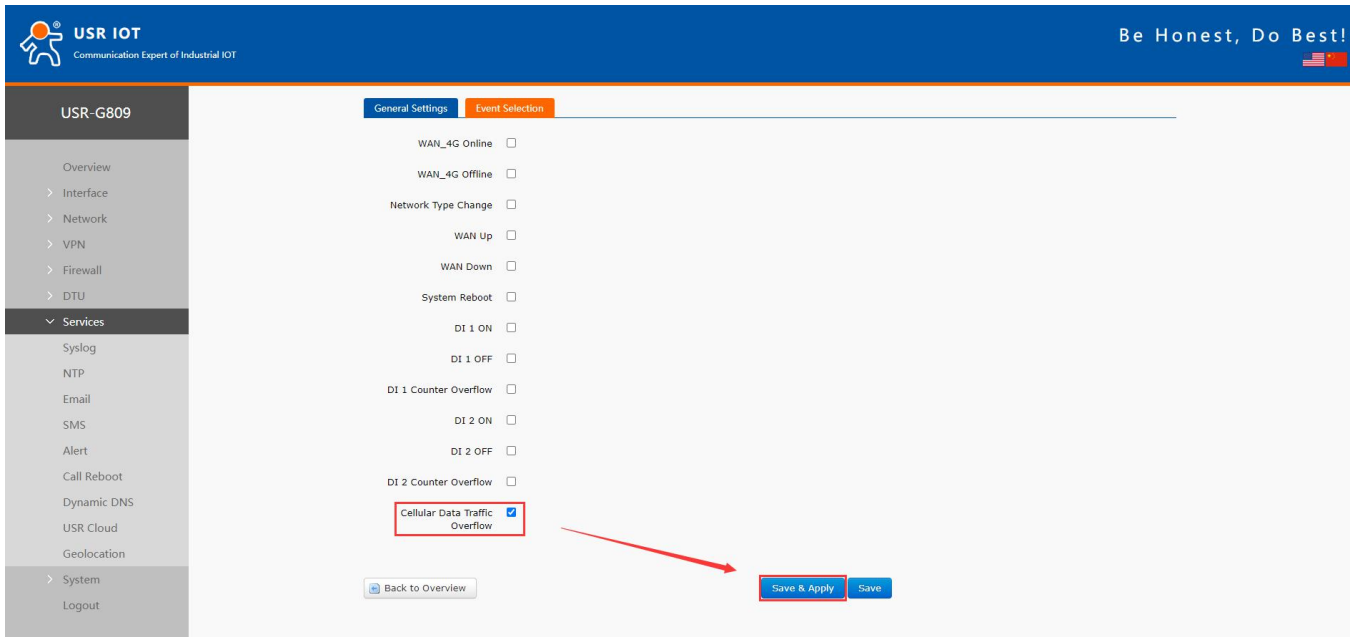

5. After setting all parameters, restart the device. When the traffic is more than 2M, will receive the alert email like below:



Description: alarm1
 Event: datattraffic
 Time: Tue Apr 27 06:00:28 2021
 Message: 37MB
 SN: 016001

9.6.2. DI 1 ON SMS Alarm

1. Insert the SIM card that supports SMS function, install the antenna.
2. Please refer to **Connecting Hardware** for the wiring of DI.
3. Power on the device with the 12V power adaptor.
4. After connecting to the network, the “NET” and “RSSI” indicator lights will be on.
5. Enable DI1, set the mode to “ON-OFF”. Click “Save&Apply”.

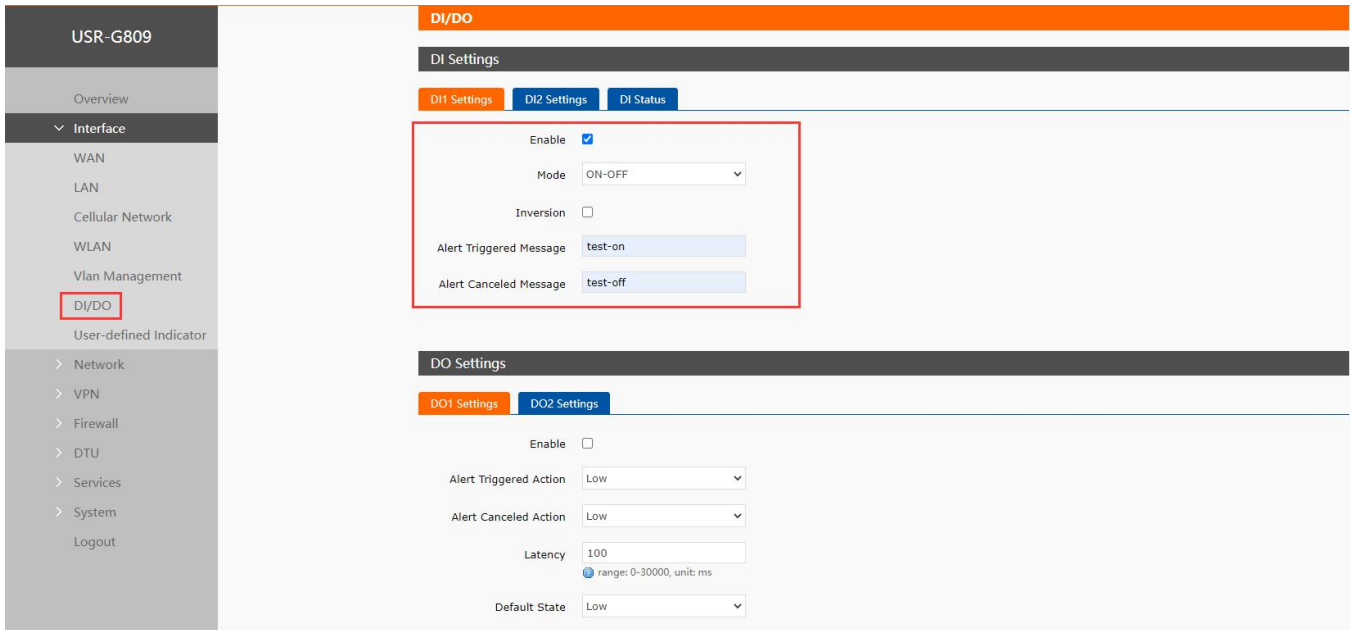

6. Send the test SMS.

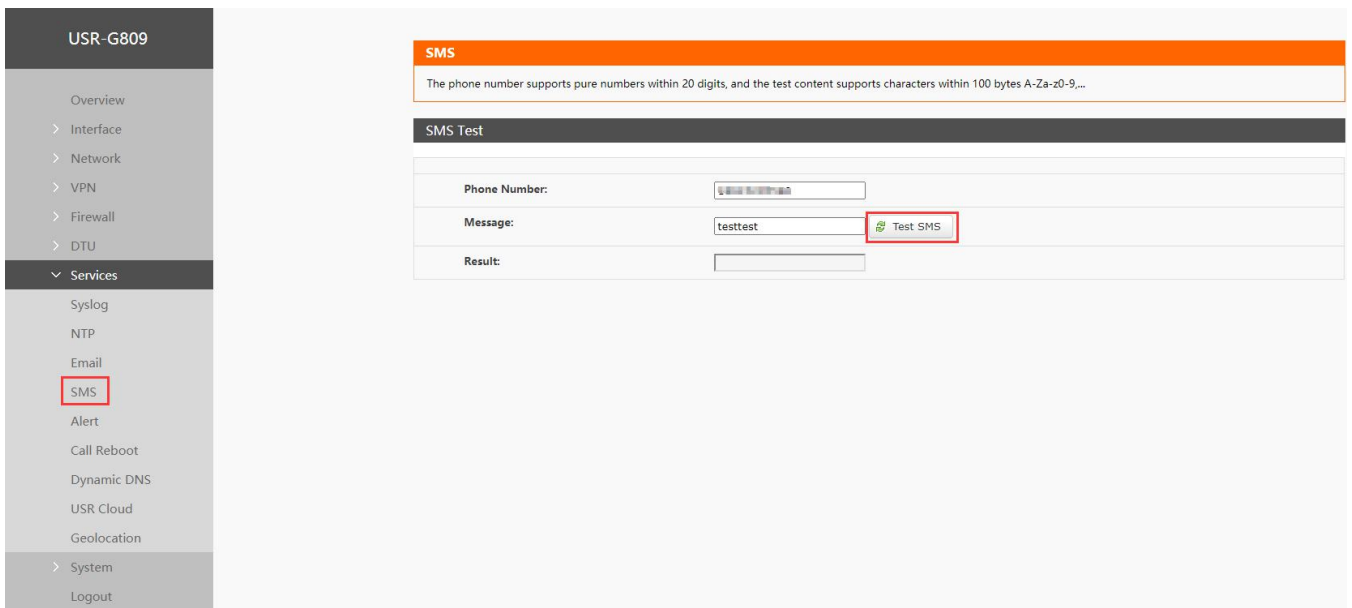

7. Add an alert. Enable SMS alarm, carrying the IMEI of the device.

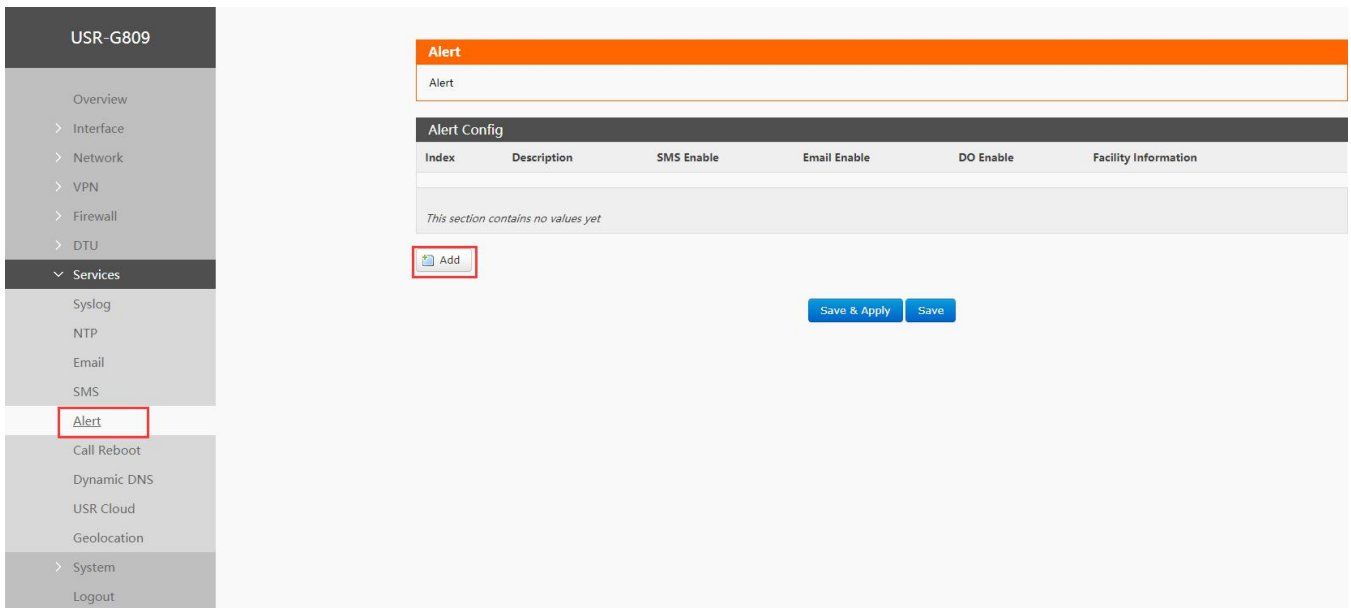
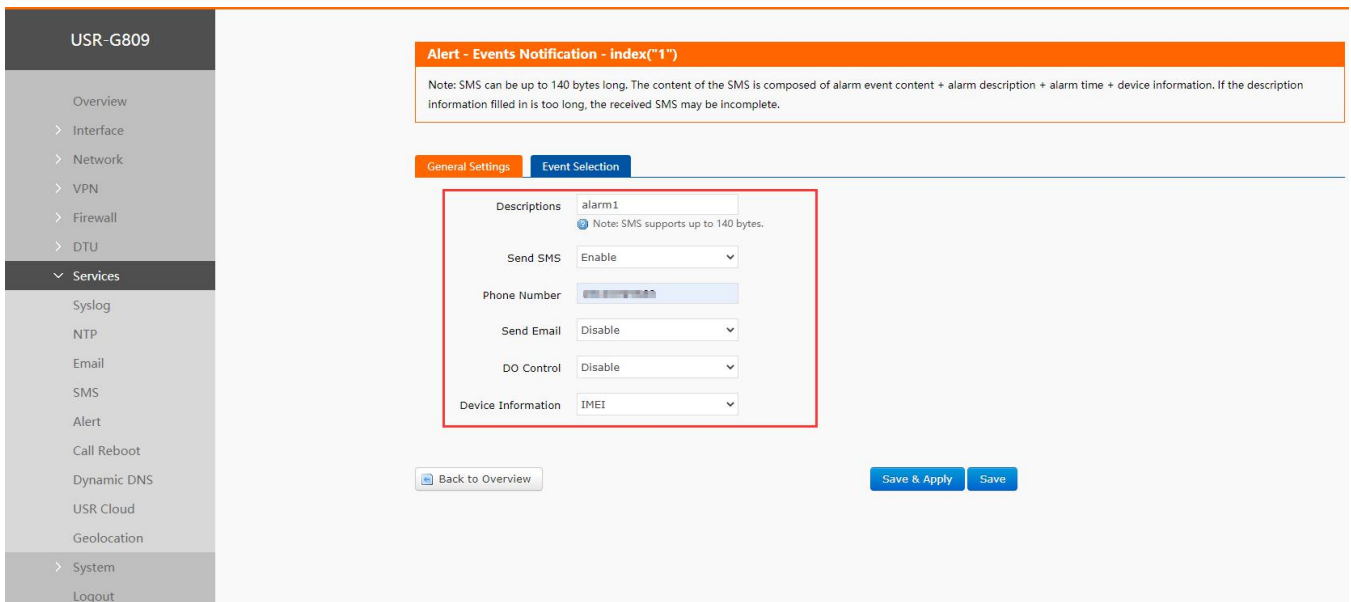
Set the event to DI 1 ON, DI 1 OFF, when DI 1 action, SMS will be sent according to the content set in step 5. Click "Save&Apply".

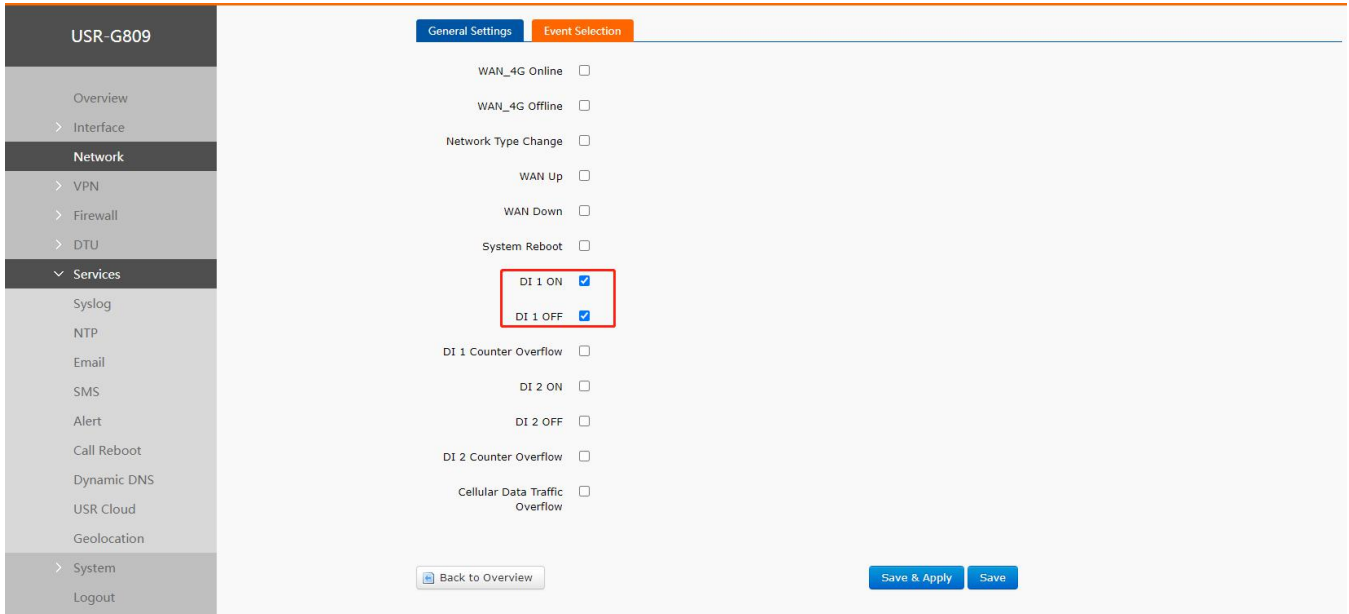

```

Description:alarm2
Event:di1on
Time:Tue Feb 23 20:30:35 2021
Message:test-on
IMEI:
    
```

```

Description:alarm2
Event:di1off
Time:Tue Feb 23 20:30:35 2021
Message:test-off
IMEI:
    
```

9.6.3.4G Online/Offline Triggers DO

1. Install the SIM card and antenna.
2. Please refer to **Connecting Hardware** for the wiring of DO.
3. Power on the device with the 12V power adaptor.
4. After connecting to the network, the “NET” and “RSSI” indicator lights will be on.
5. Enable “DO Control”, set the output level to “High”. Set the event to “WAN_4G online”.

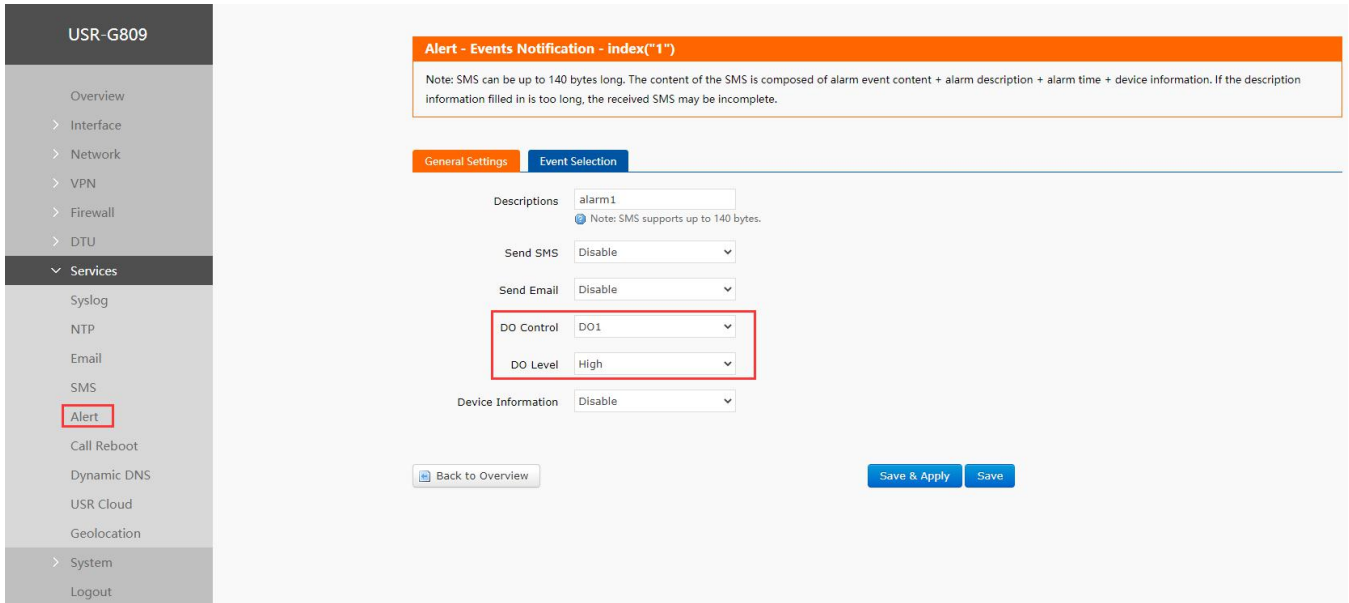

Alert - Events Notification - index("1")

Note: SMS can be up to 140 bytes long. The content of the SMS is composed of alarm event content + alarm description + alarm time + device information. If the description information filled in is too long, the received SMS may be incomplete.

General Settings | **Event Selection**

Descriptions: alarm1
Note: SMS supports up to 140 bytes.

Send SMS: Disable

Send Email: Disable

DO Control: DO1

DO Level: High

Device Information: Disable

Back to Overview | Save & Apply | Save

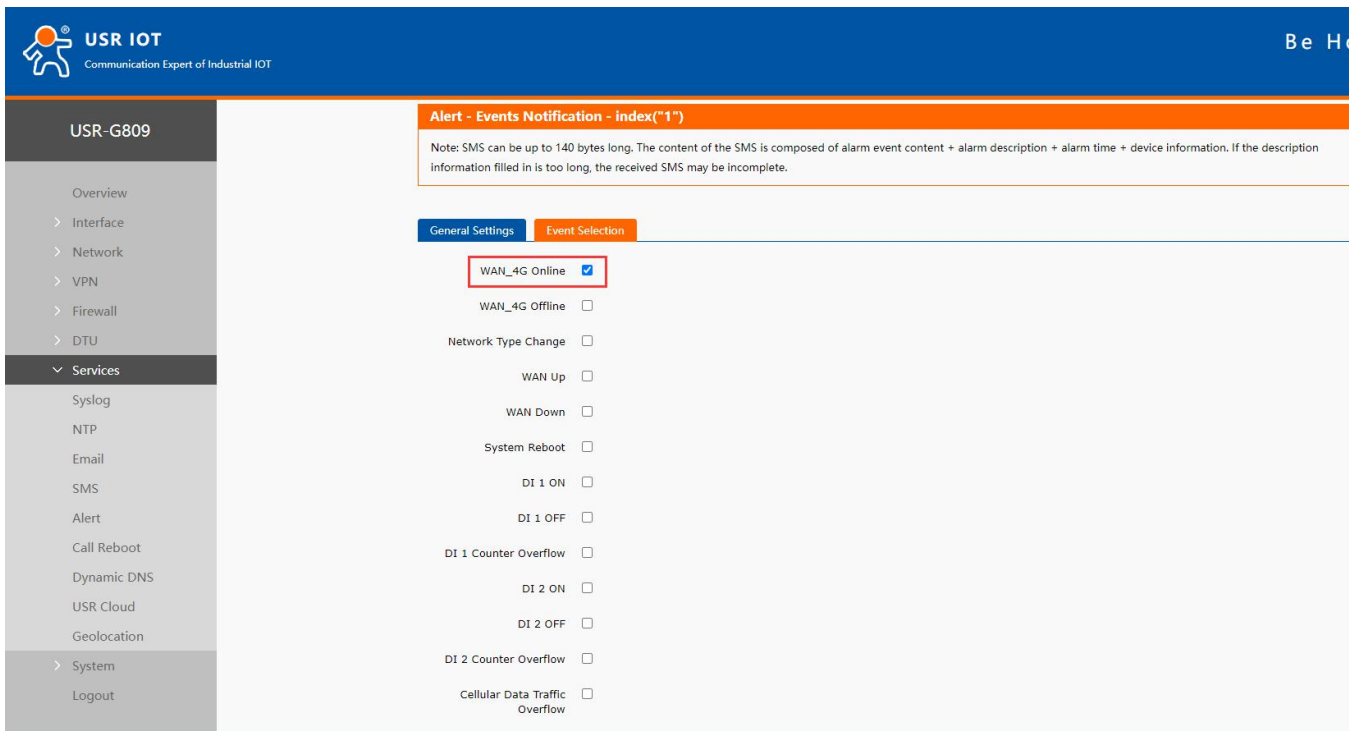

Alert - Events Notification - index("1")

Note: SMS can be up to 140 bytes long. The content of the SMS is composed of alarm event content + alarm description + alarm time + device information. If the description information filled in is too long, the received SMS may be incomplete.

General Settings | **Event Selection**

WAN_4G Online

WAN_4G Offline

Network Type Change

WAN Up

WAN Down

System Reboot

DI 1 ON

DI 1 OFF

DI 1 Counter Overflow

DI 2 ON

DI 2 OFF

DI 2 Counter Overflow

Cellular Data Traffic Overflow

Note:

- When enable DO1 control, please do not enable DO1 in “DIDO” interface to avoid the conflict.
- Please select only one event since the output is DO status.

6. Add the second alarm. Set the DO1 output level to Low, the event to WAN_4G offline. After that, click “Save&Apply”.

USR-G809

- Overview
- > Interface
- > Network
- > VPN
- > Firewall
- > DTU
- Services
- Syslog
- NTP
- Email
- SMS
- Alert
- Call Reboot
- Dynamic DNS
- USR Cloud
- Geolocation
- > System
- Logout

Alert - Events Notification - index("2")

Note: SMS can be up to 140 bytes long. The content of the SMS is composed of alarm event content + alarm description + alarm time + device information. If the description information filled in is too long, the received SMS may be incomplete.

General Settings **Event Selection**

Descriptions

Note: SMS supports up to 140 bytes.

Send SMS

Send Email

DO Control

DO Level

Device Information

USR-G809

- Overview
- > Interface
- > Network
- > VPN
- > Firewall
- > DTU
- Services
- Syslog
- NTP
- Email
- SMS
- Alert
- Call Reboot
- Dynamic DNS
- USR Cloud
- Geolocation
- > System
- Logout

Alert - Events Notification - index("2")

Note: SMS can be up to 140 bytes long. The content of the SMS is composed of alarm event content + alarm description + alarm time + device information. If the description information filled in is too long, the received SMS may be incomplete.

General Settings **Event Selection**

WAN_4G Online

WAN_4G Offline

Network Type Change

WAN Up

WAN Down

System Reboot

DI 1 ON

DI 1 OFF

DI 1 Counter Overflow

DI 2 ON

DI 2 OFF

DI 2 Counter Overflow

Cellular Data Traffic Overflow

7. When connect to the 4G network successfully, the DO1 will always be set to a high level;
 When 4G network is disconnected, the DO1 will always be set to a low level;
 When connecting DO1 to a LED, can type control the LED light on and off.

9.7. Call Reboot

After installing a SIM card that supports SMS function, when calling the SIM card in device, the device will restart and send a SMS to the caller.

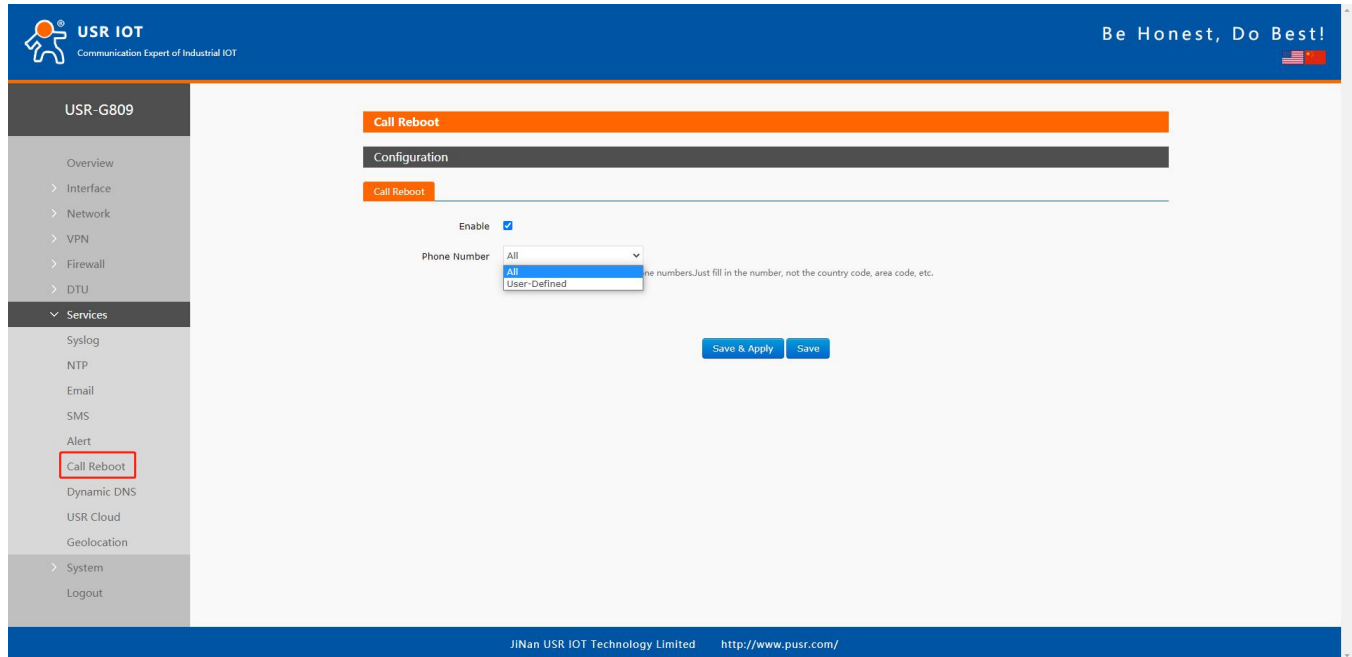

Item	Description	Default
Enable	On/Off	Off
Phone number	ALL: Call from any phone number can restart the device. User-Defined: Specified phone number, up to 20.	ALL
Custom phone number	Click “+” to add more numbers	Null

9.8. Geolocation

9.8.1. GPS Configurations

- This feature is not supported in regular versions, optional.

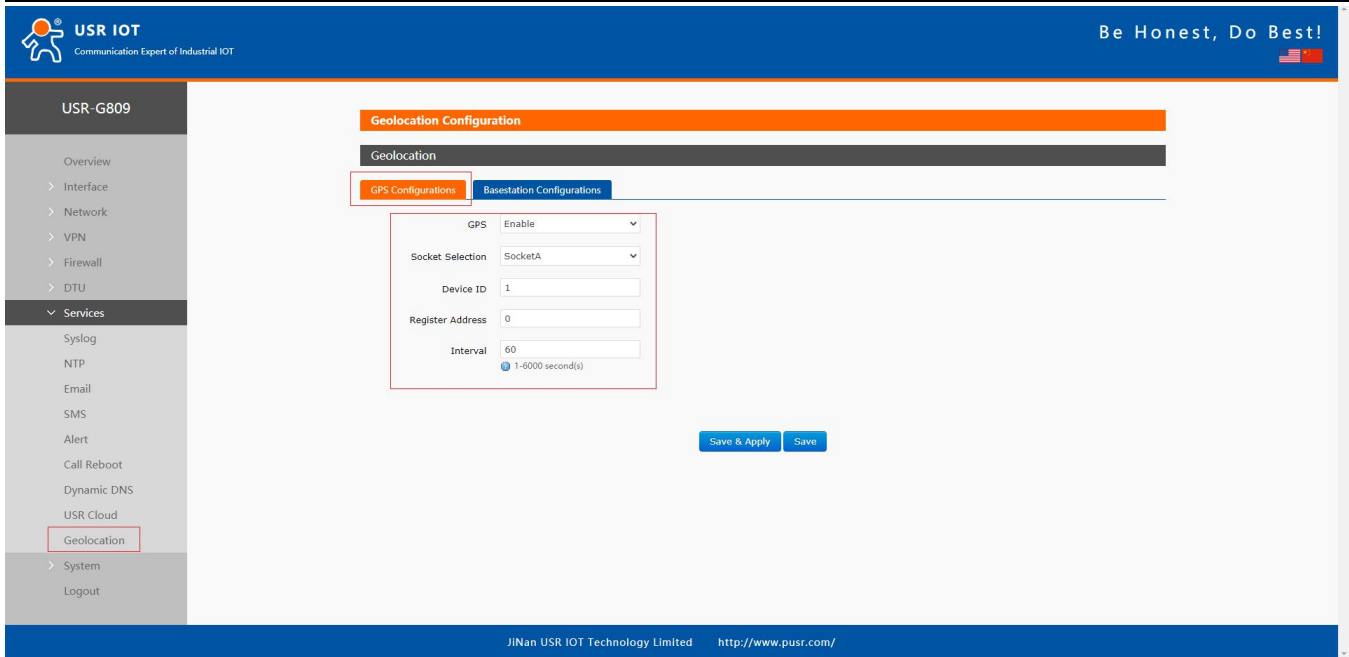

Item	Description	Default
GPS	Enable/Disable	Disable
Socket selection	SocketA or Custom	SocketA
Device ID	Modbus RTU device ID	1
Register address	Modbus RTU register address	0
Interval (s)	Uploading interval, 1-6000s	60
Server custom address	Custom GPS server address, IP or domain Item.	clouddata.usr.cn
Server port	Custom GPS server port	15000

GPS frame format:

(When the GPS sensor is abnormal and cannot locate the coordinate information, the latitude and longitude in the frame are (0.00, 0.00)).

USR-G809 will report the location data in Modbus RTU to the GPS server actively.

Data reported by G809:

01 46 00 00 00 12 24 00 06 00 01 68 90 E7 27 48 C9 40 5D C4 FD 85 AA 56 7E 40 42 01 CC 00 00 00 64 00 00 F2 59 5C 87 13 56 2D 2E

Longitude: 68 90 E7 27 48 C9 40 5D

Latitude: C4 FD 85 AA 56 7E 40 42

10 bytes base station positioning: 01 CC 00 00 00 64 00 00 F2 59

Timestamp: 5C 87 13 56

CRC: 2D 2E

9.8.2. Base Station Configurations

After enable this function, G809 will send the base station information to the server via the specified protocol format.

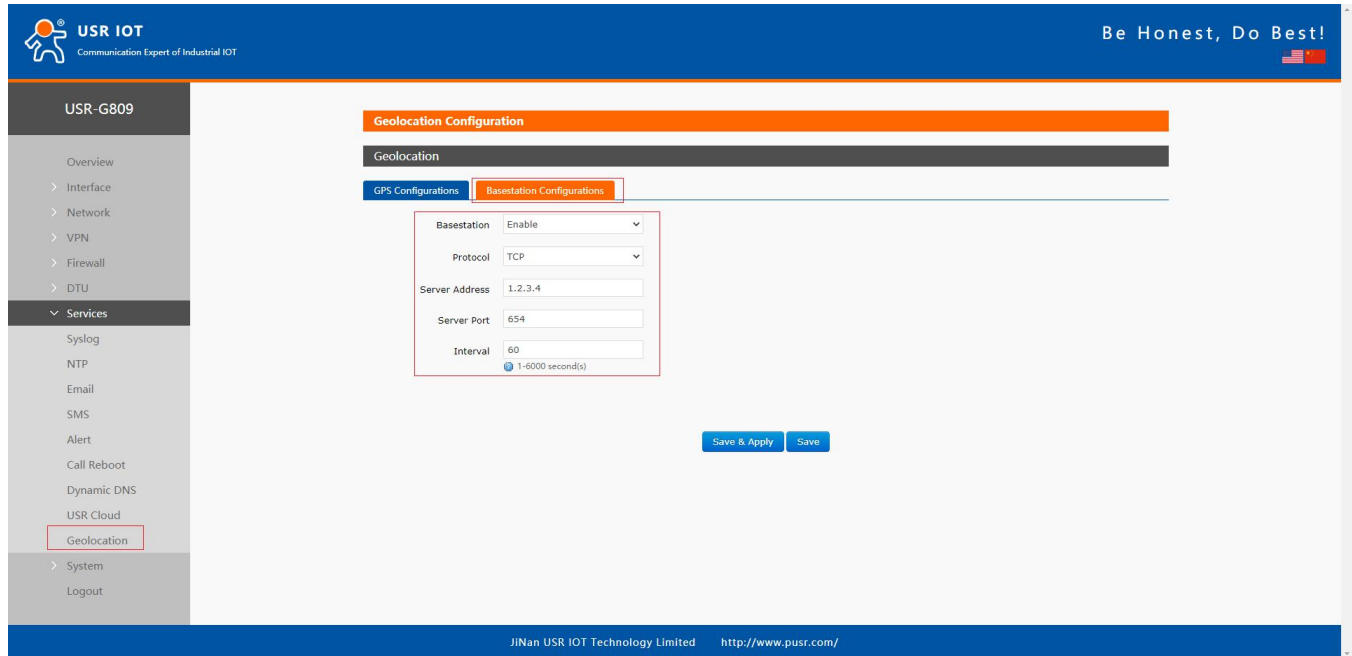

Item	Description	Default
Base station	Enable/Disable	Disable
Protocol	TCP /UDP	TCP
Server address	Specified server address, IP or domain Item	1.2.3.4
Server port	Specified server port	654
Interval (s)	Reporting interval, 1-6000s	60

9.9. DDNS

DDNS function allows remote access to the router directly through the domain Item instead of your dynamic IP address, which changes from time to time.

9.9.1. Supported Services

If you are using the DNS service provider can be found in the "Services" drop-down box, please configure like below:

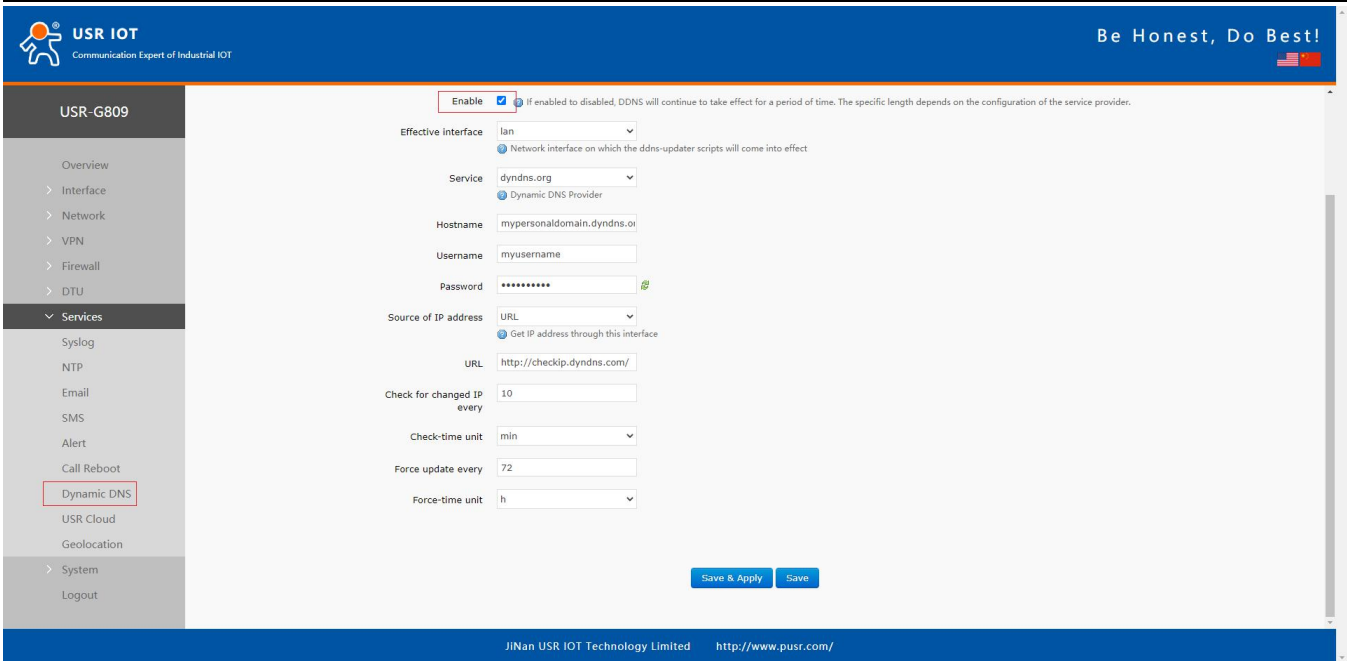

Item	Description	Default
Enable	On/Off	Off
Effective interface	lan/wan_wired/wan_4g	lan
Service	DDNS server address	dyndns.org
Hostname	Enter the hostname provided by the DDNS server.	mypersonaldomain.dyndns.org
Username	Enter the username provided by the DDNS server	myusername
Password	Enter the password provided by the DDNS server	mypassword
Source of IP address	Network/Interface/URL	URL
Interface	eth0.2/eth1	Eth0.2
URL	Set the IP source URL address	http://checkip.dyndns.com/
Network	wan_wired/wan_4g	wan_wired
Check for changed IP every/unit	The interval at which IP address changes are detected. The IP binding of the domain name may change frequently, and the lower the value, the more frequent the detection.	10 min
Force update every/unit	The time interval for forced updates.	72 h

9.9.2. Custom Services

If you are using the DNS service provider can not be found in the "Services" drop-down box, please select "Custom", then configure like below:

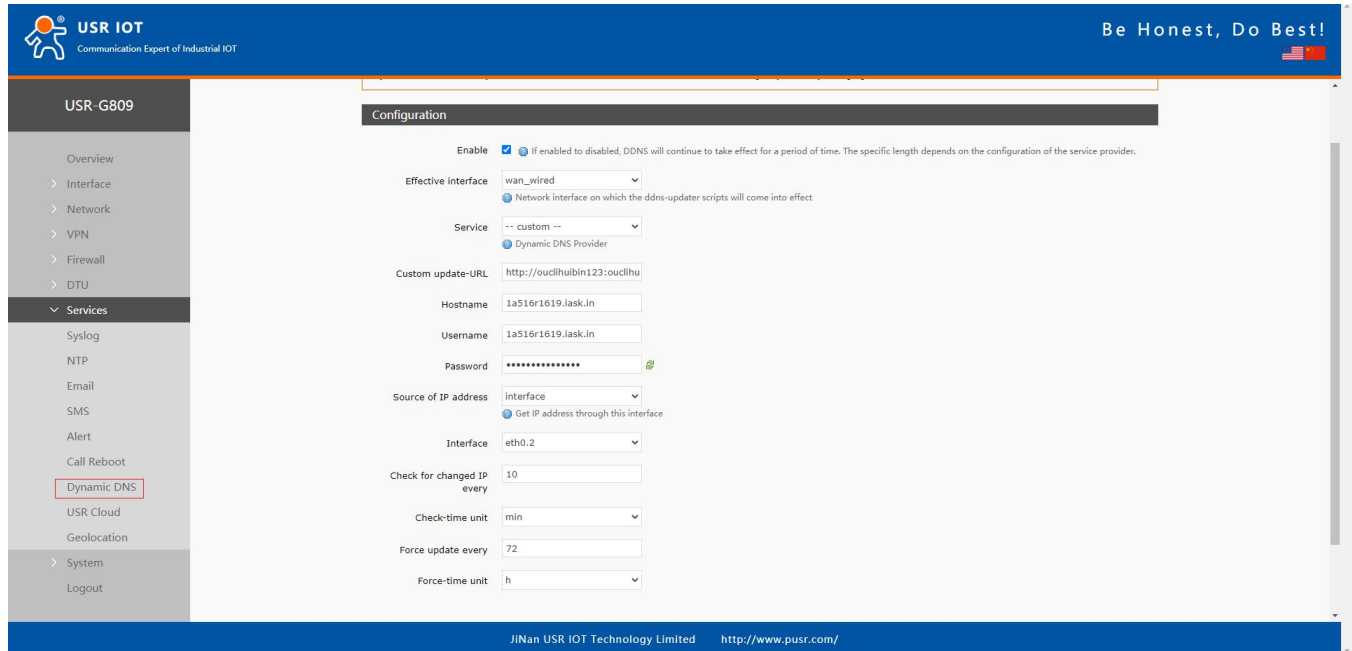

Here we use "ddns.oray.com" as an example, the hostname is "1a516r1619.iask.in", username is "ouclihuibin123", password "ouclihuibin123".

Item	Description	Default
Enable	On/Off	Off
Effective	lan/wan_wired/wan_4g	lan
Service	Custom	---
Custom update-URL	DDNS server address, here we take "ddns.oray.com" as an example. Please enter with the format of "http://username:password@ddns.oray.com/ph/update?hostname=hostname provided by the DDNS server"	Example: http://ouclihuibin123:ouclihuibin1231@ddns.oray.com/ph/update?hostname=1a516r1619.iask.in
Hostname	Enter the hostname provided by the DDNS server	Example: 1a516r1619.iask.in
Username	Enter the username provided by the DDNS server	Example: ouclihuibin123
Password	Enter the password provided by the DDNS server	Example: ouclihuibin123
Source of IP address	Network/Interface/URL	URL
Interface	eth0.2/eth1	Eth0.2
URL	Set the IP source URL address	http://checkip.dyndns.

		com/
Network	wan_wired/wan_4g	wan_wired
Check for changed IP every/unit	The interval at which IP address changes are detected. The IP binding of the domain name may change frequently, and the lower the value, the more frequent the detection.	10 min
Force update every/unit	The time interval for forced updates.	72 h

Note:

- After setting all parameters, please restart the device to take the parameters effect.
- Dynamic domain names work even if the router is in subnet.
- DDNS + port forwarding can realize remote access to the router subnet.
- This function requires the router's network to be assigned to a separate public IP.

10. AT Commands Settings

10.1. AT Command Mode

When the device works in network transparent mode or HTTP mode, can switch to "AT command mode" by sending time-specific data by serial port. When the operation is completed in "AT command mode", send specific commands to return to the previous working mode.

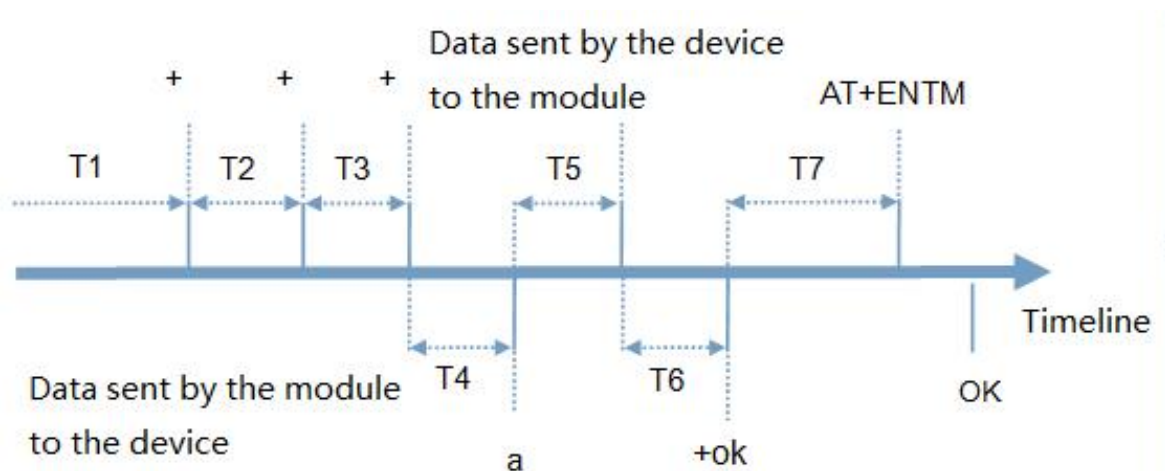

Toggles the timing of command mode:

In the figure above, the horizontal axis is time, data above the time axis is sent by the serial device to G809, data below the time axis is sent by G809 to the serial port.

Time requirement:

T1 > current serial port packaging interval
 T2 < current serial port packaging interval time
 T3 < current serial port packaging interval time
 T4 = current serial port packaging interval time
 T5 < 3 s
 T6 = current serial port packaging interval time

The time sequence of switching from transparent mode/HTTP mode to “AT Command mode” :

1. Serial device continuously sends "+++" to the device. After receiving "+++", the device will send an "a" to the serial device. No data can be sent during a packaging cycle before sending "+++".
2. When the serial device receives “a”, a “a” must be sent to the device within 3 seconds.
3. After receiving 'a', the device returns "+ok" and enter “temporary command mode”.
4. After receiving "+ok", the device has enter "temporary command mode" and now can send AT command to it.

Time sequence of switching from AT command mode to transparent mode.HTTP mode:

1. Serial device sends "AT+ENTM" to G809.
2. After receiving the command, sends "OK" to the serial device and returns to the previous working mode.
3. After the serial device receives "OK", it knows that the device has returned to its previous working mode.

10.2. Serial AT Commands

In transparent mode, do not need to switch to the command mode, we can use “Command password + AT command” to query and set parameters. It does not need complicated “+++” timing sequence to enter AT command mode, so as to quickly query or set parameters.

Before sending, enter AT command mode, query the command password firstly. It defaults to “test.cn#”. Restart the device after setting.

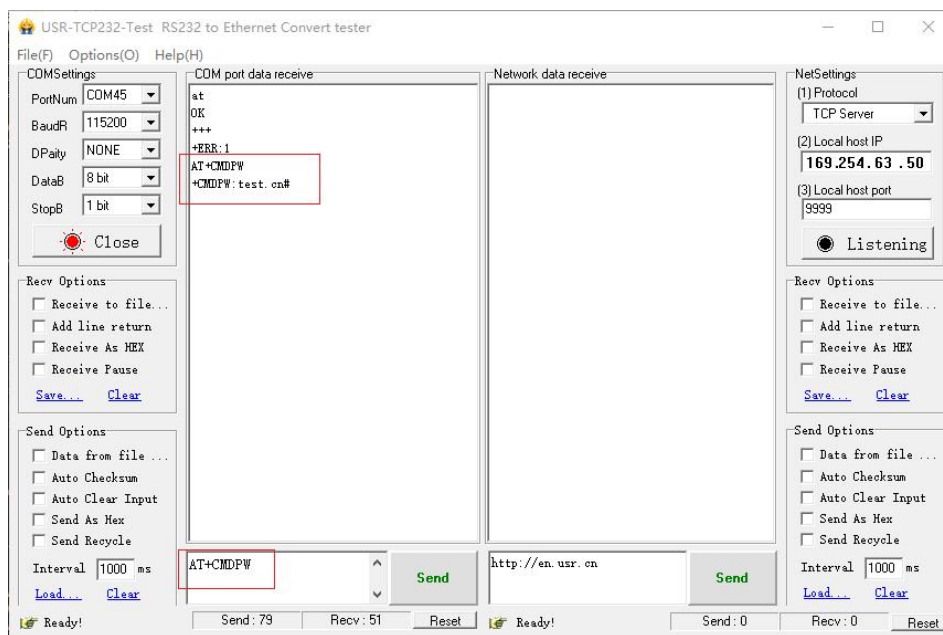

Send “test.cn#AT+MAC” from the serial port (there is an “Enter” after the command), then can receive the response from the device:

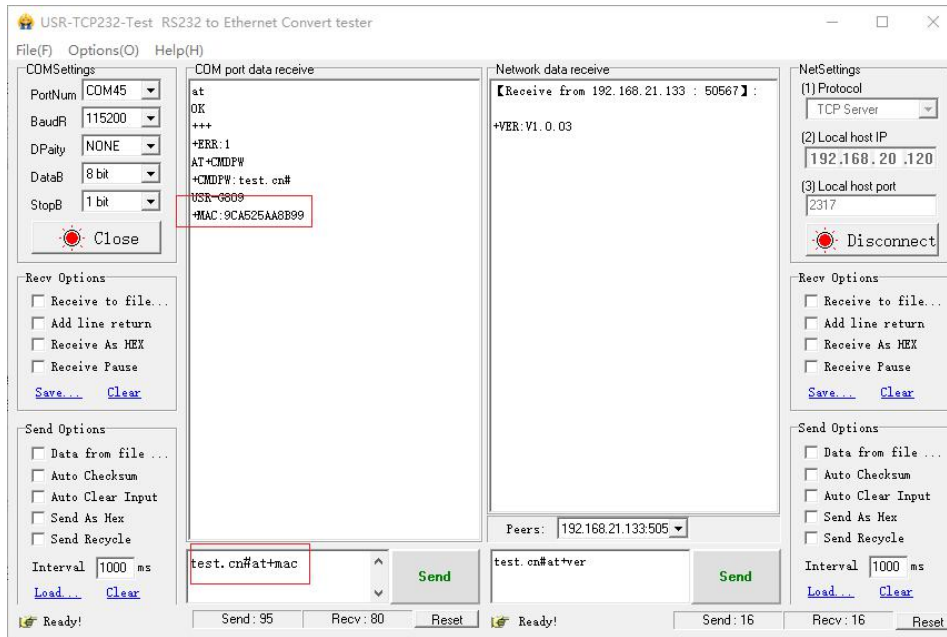

10.3. Network AT Commands

Network AT command refers to set and query parameters by sending “Command password + AT command” through the network when working in transparent mode. Here we query the firmware version of the device, there is an “Enter” after the command.

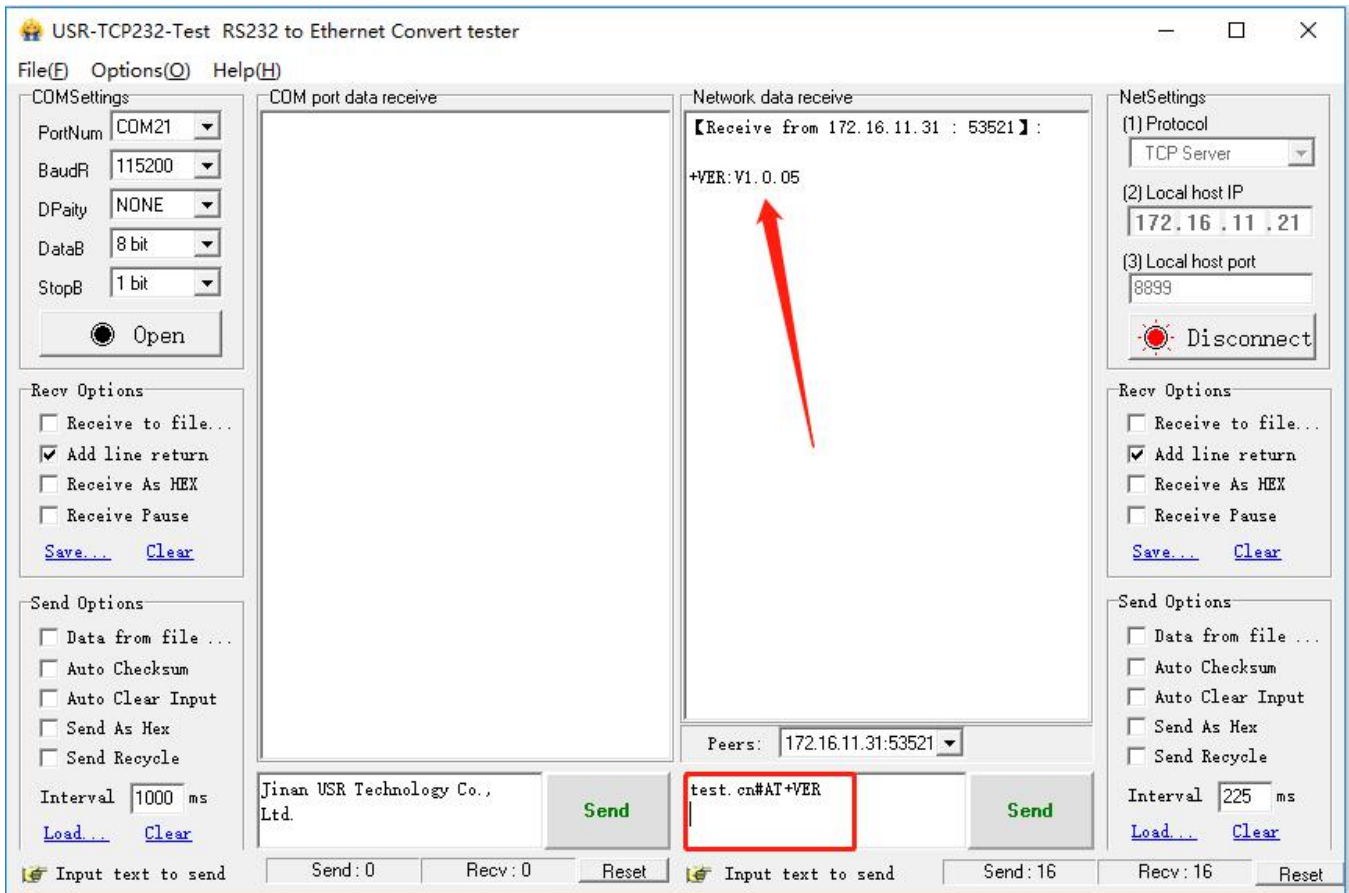

10.4. SMS AT Commands

In transparent mode, we can also send SMS to query and set the device parameters. Here we send “Command password+AT Commands” to query the socket connection status.



For detailed AT Commands, please refer to **AT Command set**.