

MGate MB3170/MB3270 Quick Installation Guide

Edition 7.1, February 2016

Technical Support Contact Information www.moxa.com/support

Moxa Americas:

Toll-free: 1-888-669-2872

Tel: 1-714-528-6777

Fax: 1-714-528-6778

Moxa China (Shanghai office):

Toll-free: 800-820-5036

Tel: +86-21-5258-9955

Fax: +86-21-5258-5505

Moxa Europe:

Tel: +49-89-3 70 03 99-0

Fax: +49-89-3 70 03 99-99

Moxa Asia-Pacific:

Tel: +886-2-8919-1230

Fax: +886-2-8919-1231

Moxa India:

Tel: +91-80-4172-9088

Fax: +91-80-4132-1045



© 2016 Moxa Inc. All rights reserved.

P/N: 1802031700014



Overview

The MGate MB3170 and MB3270 are 1 and 2-port advanced Modbus gateways that convert between Modbus TCP and Modbus ASCII/RTU protocols. They can be used to allow Ethernet masters to control serial slaves, or to allow serial masters to control Ethernet slaves. Up to 32 TCP masters and 31 serial slaves can be connected simultaneously.

Package Checklist

Before installing the MGate MB3170 or MB3270, verify that the package contains the following items:

- MGate MB3170 or MB3270 Modbus gateway
- Document & Software CD
- Quick Installation Guide
- Product Warranty Statement

Optional Accessories:

- **DK-35A:** DIN-rail mounting kit (35 mm)
- **Mini DB9F-to-TB Adaptor:** DB9 female to terminal block adapter
- **DR-4524:** 45W/2A DIN-rail 24 VDC power supply with universal 85 to 264 VAC input
- **DR-75-24:** 75W/3.2A DIN-rail 24 VDC power supply with universal 85 to 264 VAC input
- **DR-120-24:** 120W/5A DIN-rail 24 VDC power supply with 88 to 132 VAC/176 to 264 VAC input by switch

Please notify your sales representative if any of the above items is missing or damaged.

Hardware Introduction

LED Indicators

Name	Color	Function
PWR1	Red	Power is being supplied to the power input
PWR2	Red	Power is being supplied to the power input
RDY	Red	Steady: Power is on and the unit is booting up
		Blinking: IP conflict, DHCP or BOOTP server did not respond properly, or a relay output occurred
	Green	Steady: Power is on and the unit is functioning normally
		Blinking: Unit is responding to locate function
	Off	Power is off or power error condition exists
Ethernet	Amber	10 Mbps Ethernet connection
	Green	100 Mbps Ethernet connection
	Off	Ethernet cable is disconnected or has a short
P1, P2	Amber	Serial port is receiving data
	Green	Serial port is transmitting data
	Off	Serial port is not transmitting or receiving data
FX	Amber	Steady on: Ethernet fiber connection, but port is idle.
		Blinking: Fiber port is transmitting or receiving data.
	Off	Fiber port is not transmitting or receiving data.

Reset Button

Press the Reset button continuously for 5 sec to load factory defaults:

The reset button is used to load factory defaults. Use a pointed object such as a straightened paper clip to hold the reset button down for five seconds. Release the reset button when the Ready LED stops blinking.

Panel Layouts

The MGate MB3170 has a male DB9 port and a terminal block for connecting to serial devices. The MGate MB3270 has two DB9 connectors for connecting to serial devices.

Top View

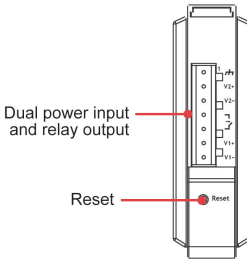

Front View

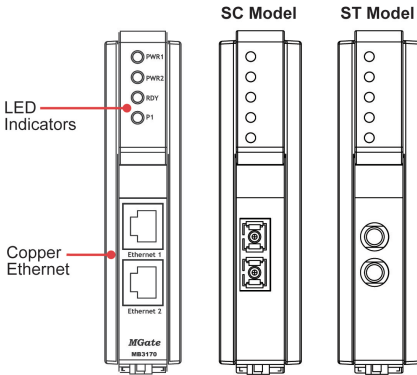

Bottom View

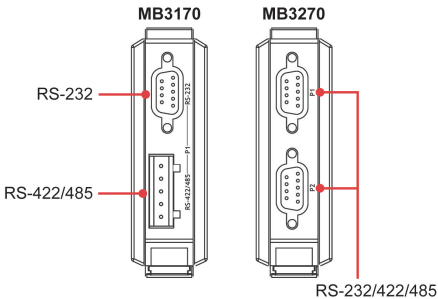

Hardware Installation Procedure

- STEP 1:** Use a standard straight-through Ethernet (fiber) cable to connect the unit to a network hub or switch.
- STEP 2:** Connect your device to the unit's serial port.
- STEP 3:** Mount the unit on a DIN-rail.
- STEP 4:** Connect the power source to power input.

Software Installation Information

To install MGate Manager, insert the MGate Documentation and Software CD into your PC's CD-ROM drive, and then run the following setup program to begin the installation process from the "Software" directory:
MGM_Setup_[Version]_Build_[DateTime].exe

The filename of the latest version may have the following format:
MGM_Setup_Verx.x.x_Build_xxxxxxxx.exe.

For detailed information about MGate Manager, refer to the MGate MB3000 User's Manual, which can be found in the "Document" directory.

Pin Assignments

Ethernet Port (RJ45)

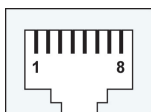

Pin	Signal
1	Tx+
2	Tx-
3	Rx+
6	Rx-

Serial Port (DB9 Male*)

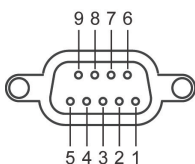

Pin	RS-232	RS-422/ RS-485 (4W)	RS-485 (2W)
1	DCD	TxD-	-
2	RxD	TxD+	-
3	TxD	RxD+	Data+
4	DTR	RxD-	Data-
5	GND	GND	GND
6	DSR	-	-
7	RTS	-	-
8	CTS	-	-
9	-	-	-

*Note: For the MB3170 series, the DB9 male port can only be used for RS-232.

Serial Port (Terminal Block)

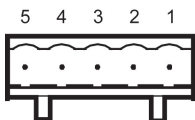

Pin	RS-422/ RS-485 (4W)	RS-485 (2W)
1	TxD+	-
2	TxD-	-
3	RxD+	Data+
4	RxD-	Data-
5	GND	GND

Power Input and Relay Output Pinouts

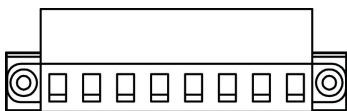

	V2+	V2-				V1+	V1-
Shielded Ground	DC Power Input 1	DC Power Input 1	N.O.	Common	N.C.	DC Power Input 2	DC Power Input 2

Optical Fiber Interface

		100BaseFX		
		Multi-mode		Single-mode
Fiber Cable Type		OM1	50/125 μ m	G.652
			Typical Distance	
Wave-length	Typical (nm)	1300		1310
	TX Range (nm)	1260 to 1360		1280 to 1340
	RX Range (nm)	1100 to 1600		1100 to 1600
Optical Power	TX Range (dBm)	-10 to -20		0 to -5
	RX Range (dBm)	-3 to -32		-3 to -34
	Link Budget (dB)	12		29
	Dispersion Penalty (dB)	3		1

Note: When connecting a single-mode fiber transceiver, we recommend using an attenuator to prevent damage caused by excessive optical power.

Note: Compute the "typical distance" of a specific fiber transceiver as follows: Link budget (dB) > dispersion penalty (dB) + total link loss (dB).

Specifications

Power Requirements

Power Input	12 to 48 VDC
Power Consumption	
MB3170:	435 mA @ 12 V, 218 mA @ 24 V, 109 mA @ 48 V
MB3170I:	555 mA @ 12 V, 278 mA @ 24 V, 138 mA @ 48 V
MB3270:	435 mA @ 12 V, 218 mA @ 24 V, 109 mA @ 48 V
MB3270I:	510 mA @ 12 V, 255 mA @ 24 V, 128 mA @ 48 V

Operating Temperature 0 to 60°C (32 to 140°F),
-40 to 75°C (-40 to 167°F) for -T model

Storage Temperature -40 to 85°C (-40 to 185°F)

Operating Humidity 5 to 95% RH

Magnetic Isolation 2 kV (for "I" models)

Protection (serial)

Dimensions

Without ears:	29 x 89.2 x 118.5 mm (1.14 x 3.51 x 4.67 in)
With ears extended:	29 x 89.2 x 124.5 mm (1.14 x 3.51 x 4.90 in)

Relay Output	1 digital relay output to alarm (normal close): current carrying capacity 1 A @ 30 VDC
Hazardous Location	UL/cUL Class 1 Division 2 Group A/B/C/D, ATEX Zone 2, IECEx

This device complies with Part 15 of the FCC rules.

Operation is subject to the following conditions:

1. This device may not cause harmful interference.
2. This device must accept any interference received, including interference that may cause undesired operation.

ATEX and IECEx Information



1. DEMKO Certification number: 07 ATEX 0690059X IEC Certification Number: IECEx UL 13.0023X (only for models with suffix –CT or – IEX)
2. Ambient Temperature Range ($-40^{\circ}\text{C} \leq T_{\text{amb}} \leq 75^{\circ}\text{C}$)
3. Certification String: Ex nA IIC T3 Gc
4. Standards Covered: EN 60079-0:2012/IEC 60079-0 6th Ed. AND EN 60079-15:2010/IEC 60079-15 4th Ed.
5. The conditions of safe usage:
 - The Ethernet Communications Devices are intended for mounting in a tool-accessible IP54 enclosure and used in an area of not more than pollution degree 2 as defined by IEC 60664-1.
 - Conductors suitable for use in an ambient temperature greater than 114°C must be used for the power supply terminal.
 - A 4mm² conductor must be used when connection to the external grounding screw is utilized.
 - Provisions shall be made, either in the equipment or external to the equipment, to prevent the peak rated voltage being exceeded by the transient disturbances of more than 140%.