

DrayTek

Vigor2620 LTE Series LTE Router



QUICK START GUIDE (RF MODEL)

V1.0

Vigor2620 LTE Series LTE Router Quick Start Guide (For RF Model)

Version: 1.0

Firmware Version: V3.8.11

(For future update, please visit DrayTek web site)

Date: April 8, 2019

Intellectual Property Rights (IPR) Information

Copyrights

© All rights reserved. This publication contains information that is protected by copyright. No part may be reproduced, transmitted, transcribed, stored in a retrieval system, or translated into any language without written permission from the copyright holders.

Trademarks

The following trademarks are used in this document:

- Microsoft is a registered trademark of Microsoft Corp.
- Windows, Windows 95, 98, Me, NT, 2000, XP, Vista, 7, 8 and Explorer are trademarks of Microsoft Corp.
- Apple and Mac OS are registered trademarks of Apple Inc.
- Other products may be trademarks or registered trademarks of their respective manufacturers.

Safety Instructions and Approval

Safety

Instructions

- Read the installation guide thoroughly before you set up the router.
- The router is a complicated electronic unit that may be repaired only by authorized and qualified personnel. Do not try to open or repair the router yourself.
- Do not place the router in a damp or humid place, e.g. a bathroom.
- Do not stack the routers.
- The router should be used in a sheltered area, within a temperature range of +5 to +40 Celsius.
- Do not expose the router to direct sunlight or other heat sources. The housing and electronic components may be damaged by direct sunlight or heat sources.
- Do not deploy the cable for LAN connection outdoor to prevent electronic shock hazards.
- Keep the package out of reach of children.
- When you want to dispose of the router, please follow local regulations on conservation of the environment.

Warranty

We warrant to the original end user (purchaser) that the router will be free from any defects in workmanship or materials for a period of two (2) years from the date of purchase from the dealer. Please keep your purchase receipt in a safe place as it serves as proof of date of purchase. During the warranty period, and upon proof of purchase, should the product have indications of failure due to faulty workmanship and/or materials, we will, at our discretion, repair or replace the defective products or components, without charge for either parts or labor, to whatever extent we deem necessary to restore the product to proper operating condition. Any replacement will consist of a new or re-manufactured functionally equivalent product of equal value, and will be offered solely at our discretion. This warranty will not apply if the product is modified, misused, tampered with, damaged by an act of God, or subjected to abnormal working conditions. The warranty does not cover the bundled or licensed software of other vendors. Defects which do not significantly affect the usability of the product will not be covered by the warranty. We reserve the right to revise the manual and online documentation and to make changes from time to time in the contents hereof without obligation to notify any person of such revision or changes.



Declaration of Conformity

Hereby, DrayTek Corporation declares that the radio equipment type Vigor2620 is in compliance with Directive 2014/53/EU.

The full text of the EU Declaration of Conformity is available at the following internet address:

<http://www.draytek.com.tw/ftp/Vigor2620/Document/CE/>

Manufacturer: DrayTek Corp.

Address: No. 26, Fu Shing Road, HuKou Township, HsinChu Industrial Park, Hsin-Chu County, Taiwan 303

Product: Vigor2620 Series

Frequency Information for Europe area:

2.4G WLAN	2412MHz - 2472 MHz, max. TX power: 19.98dBm *1
LTE	B1[1920-1980 MHz (TX); 2110-2170 MHz (RX)]; B3[1710-1785 MHz (TX); 1805-1880 MHz (RX)]; B7[2500-2570 MHz (TX); 2620-2690 MHz (RX)]; B8[880-915 MHz (TX); 925-960 MHz (RX)]; B20[832-862 MHz (TX); 791-821 MHz (RX)]; *2
3G	B1[1920-1980 MHz (TX); 2110-2170 MHz (RX)]; B8[880-915 MHz (TX); 925-960 MHz (RX)] *2

(*1: for 2.4G WLAN model; *2: for LTE model)

This product is designed for LTE, DSL and 2.4GHz WLAN network throughout the EC region.



Regulatory Information

Federal Communication Commission Interference Statement

This equipment has been tested and found to comply with the limits for a Class B digital device, pursuant to Part 15 of the FCC Rules. These limits are designed to provide reasonable protection against harmful interference in a residential installation. This equipment generates, uses and can radiate radio frequency energy and, if not installed and used in accordance with the instructions, may cause harmful interference to radio communications. However, there is no guarantee that interference will not occur in a particular installation. If this equipment does cause harmful interference to radio or television reception, which can be determined by turning the equipment off and on, the user is encouraged to try to correct the interference by one of the following measures:

- Reorient or relocate the receiving antenna.
- Increase the separation between the equipment and receiver.
- Connect the equipment into an outlet on a circuit different from that to which the receiver is connected.
- Consult the dealer or an experienced radio/TV technician for help.

This device complies with Part 15 of the FCC Rules. Operation is subject to the following two conditions:

- (1) This device may not cause harmful interference, and
- (2) This device may accept any interference received, including interference that may cause undesired operation.

USA Local Representative	Company name	ABP International Inc.		
	Address	13988 Diplomat Drive Suite 180 Dallas TX 75234		
	ZIP Code	75234	E-mail	rmesser@abptech.com
	Contact Person	Mr. Robert Messer	Tel.	19728311600

Caution: Any changes or modifications not expressly approved by the party responsible for compliance could void the user's authority to operate the equipment.

The antenna/transmitter should be kept at least 20 cm away from human body.

DrayTek Vigor2620 series VDSL2/ADSL2+ routers are compliant with 47 C.F.R. Part 68.



More update, please visit www.draytek.com.

Table of Contents

1. Introduction.....	1
2. Package Content	2
3. Panel Explanation.....	3
3.1 Vigor2620L / Vigor2620Le.....	3
3.2 Vigor2620Ln / Vigor2620Lne.....	5
4. Hardware Installation	7
4.1 Network Connection via LTE	7
4.2 Network Connection via DSL	8
4.2 Wall-Mounted Installation.....	9
5. Software Configuration	10
5.1 Quick Start Wizard for Network Connection.....	10
6. Customer Service	13

1. Introduction

Vigor2620 LTE series is a router equipped with an LTE module which allows you to access the Internet via a SIM card.



By adopting hardware-based VPN platform and hardware encryption of AES/DES/3DES, and hardware key hash of SHA-1/MD5, the router increases the performance of VPN greatly and offers several protocols (such as IPSec/PPTP/L2TP).

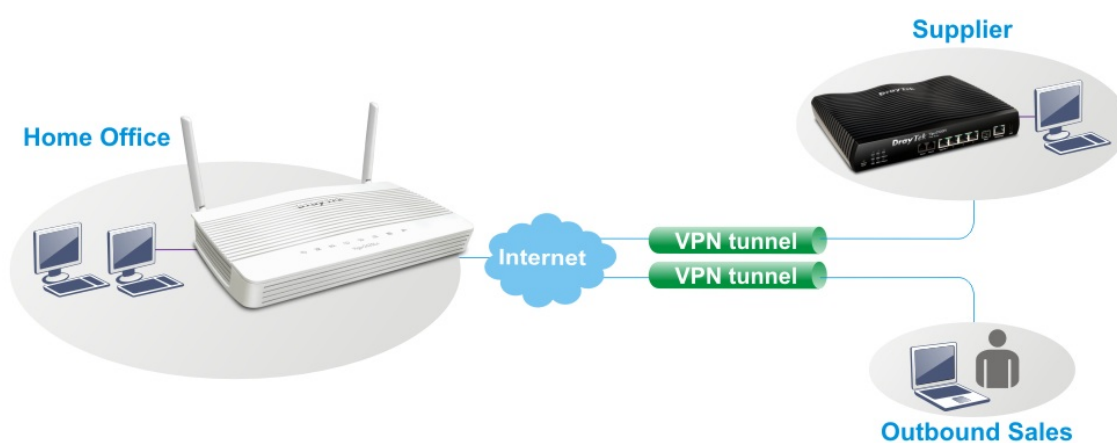

With multi-subnet for secure and efficient workgroup management, Vigor router integrates IP layer QoS, NAT session/bandwidth management to help users control works well with large bandwidth.

The object-based design used in SPI (Stateful Packet Inspection) firewall allows users to set firewall policy with ease. CSM (Content Security Management) provides users control and management in IM (Instant Messenger) and P2P (Peer to Peer) more efficiency than before.

In addition, DoS/DDoS prevention and URL/Web content filter strengthen the security outside and control inside.

2. Package Content

Take a look at the package content. If there is anything missed or damaged, please contact DrayTek or dealer immediately.



Vigor Router

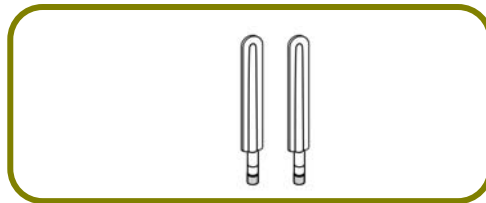

LTE Antenna



**RJ-45 to RJ-45 Cable
(Annex B)**



**RJ-11 to RJ-45 Cable (Annex B)
RJ-11 to RJ-11 Cable (Annex A)**

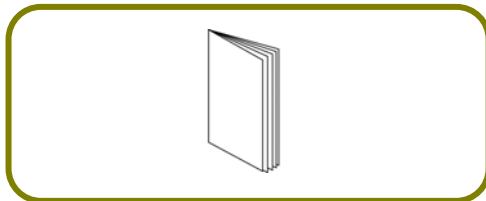

Quick Start Guide

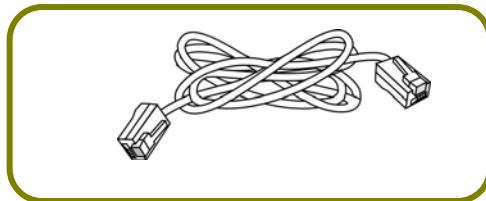

RJ-45 Cable (Ethernet)

The type of the power adapter depends on the country that the router will be installed.

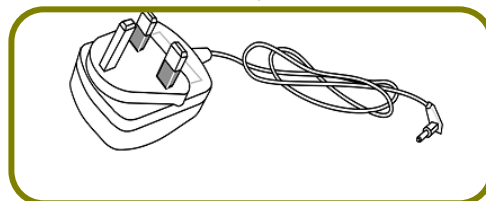

UK-type Power Adapter

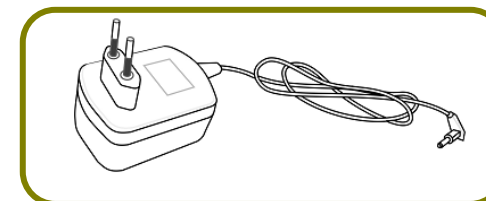

EU-type Power Adapter

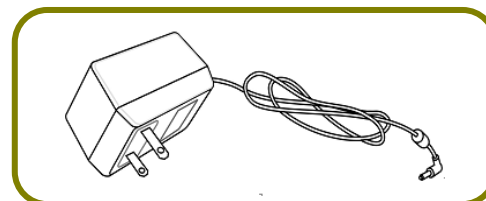

USA/Taiwan-type Power Adapter

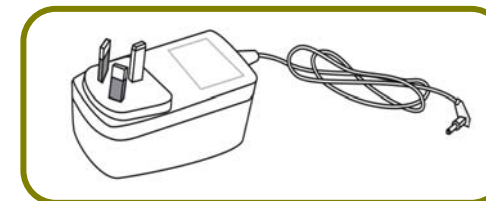

AU/NZ-type Power Adapter



Note

Important: Remove protective film before use to ensure ventilation.

3. Panel Explanation

3.1 Vigor2620L / Vigor2620Le

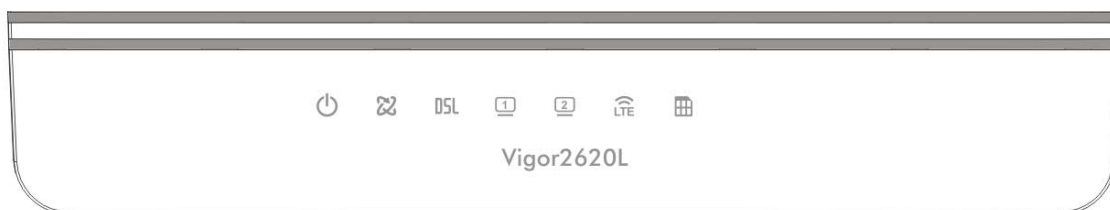

LED	Status	Explanation
	Off	The router is powered off.
	Blinking	The router is powered on and running normally.
	On	The router is ready to access Internet.
	Off	The router is not ready to access Internet.
	Blinking	Slowly: The DSL connection is ready. Quickly: The DSL connection is establishing.
	On	Physical line has been connected.
	Blinking	The connection is training.
 (for Vigor2620L)	On	The LAN port is connected.
	Blinking	The data is transmitting through the LAN port.
 (for Vigor2620Le)	On	The LAN port is connected.
	Blinking	The data is transmitting through the LAN port.
	On	LTE device is connected and ready for use.
	Off	LTE device is not detected, or has serious problem (e.g., no SIM card, SIM pin error, SIM deactivated, and etc.).
	Blinking	Vigor device performs initial access procedure.
 (for Vigor2620L)	On	SIM card is inserted into the slot and detected by Vigor device.
	Blinking	No SIM card in detected.

Vigor2620L,

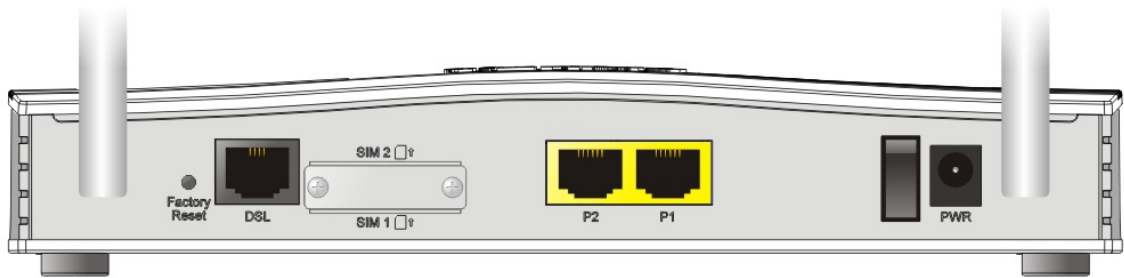



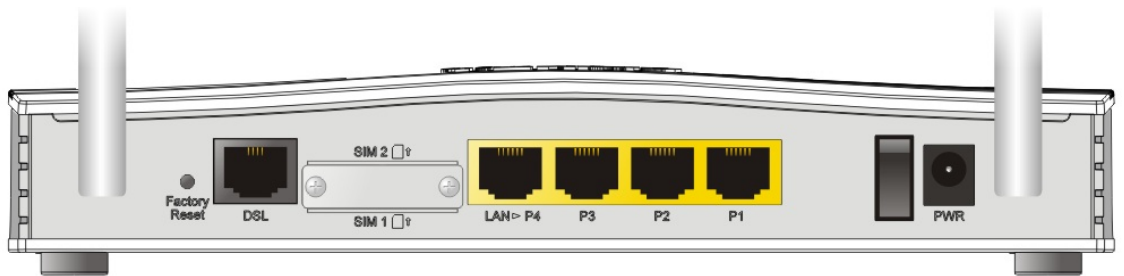





Vigor2620Le,



Interface	Description
Factory Reset	Restore the default settings. Usage: Turn on the router (ACT LED is blinking). Press the hole and keep for more than 5 seconds. When you see the ACT LED begins to blink rapidly than usual, release the button. Then the router will restart with the factory default configuration.
DSL	Connector for accessing the Internet.
SIM2/SIM1	SIM card slot(s).
P2-P1 (Vigor2620L)	Connectors for local network devices.
P4-P1 (Vigor2620Le)	Connectors for local network devices.
ON/OFF	Power Switch.
PWR	Connector for a power adapter.

3.2 Vigor2620Ln / Vigor2620Lne



LED	Status	Explanation
	Off	The router is powered off.
	Blinking	The router is powered on and running normally.
	On	The router is ready to access Internet.
	Off	The router is not ready to access Internet.
	Blinking	Slowly: The DSL connection is ready. Quickly: The DSL connection is establishing.
	On	Physical line has been connected.
	Blinking	The connection is training.
 (for Vigor2620Ln)	On	The LAN port is connected.
	Blinking	The data is transmitting through the LAN port.
 (for Vigor2620Lne)	On	The LAN port is connected.
	Blinking	The data is transmitting through the LAN port.
	On	LTE device is connected and ready for use.
	Off	LTE device is not detected, or has serious problem (e.g., no SIM card, SIM pin error, SIM deactivated, and etc.).
	Blinking	Vigor device performs initial access procedure.
 (for Vigor2620Ln)	On	SIM card is inserted into the slot and detected by Vigor device.
	Blinking	No SIM card in detected.
	On	Vigor device is ready for sending wireless signal.
	Off	No wireless signal is sent out.
	Blinking	The data is transmitting via wireless connection.

Vigor2620Ln,

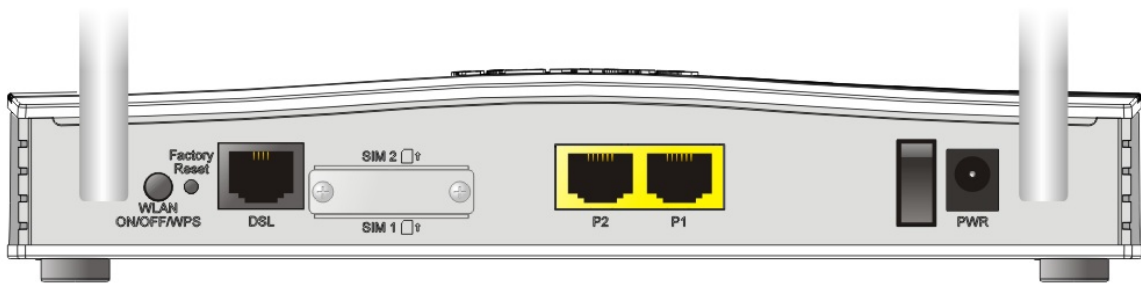

Vigor2620Lne,

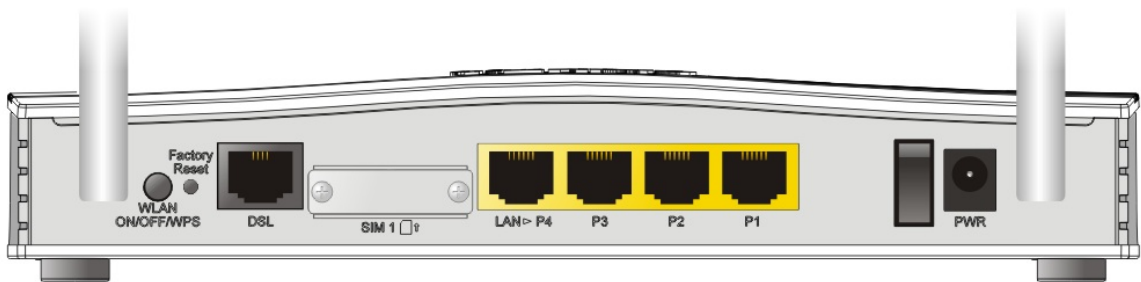

Interface	Description
Wireless LAN ON/OFF/WPS	<ul style="list-style-type: none"> ● Press the button and release it within 2 seconds. When the wireless function is ready, the green LED will be on. ● Press the button and release it within 2 seconds to turn off the WLAN function. When the wireless function is not ready, the LED will be off. ● When WPS function is enabled by web user interface, press this button for more than 2 seconds to wait for client's device making network connection through WPS.
Factory Reset	Restore the default settings. Usage: Turn on the router (ACT LED is blinking). Press the hole and keep for more than 5 seconds. When you see the ACT LED begins to blink rapidly than usual, release the button. Then the router will restart with the factory default configuration.
DSL	Connector for accessing the Internet.
SIM2/SIM1 (Vigor2620Ln)	SIM card slot(s).
SIM1 (Vigor2620Lne)	SIM card slot(s).
P2-P1	Connecters for local network devices.
ON/OFF	Power Switch.
PWR	Connector for a power adapter.

4. Hardware Installation

This section will guide you to install the router through hardware connection and configure the router's settings through web browser.

Before starting to configure the router, you have to connect your devices correctly.

4.1 Network Connection via LTE

1. Install the SIM card into the card slot. The back plate of the SIM card slot must be removed first and the direction of card notch must be on the left side.



After installing the SIM card, fasten the back plate again.

2. Connect to your computer with a RJ-45 cable.
3. Connect one end of the power cord to the power port of this device. Connect the other end to the wall outlet of electricity.
4. Power on the router.
5. Check the **power**, **LTE** and **LAN** LEDs to assure network connections.

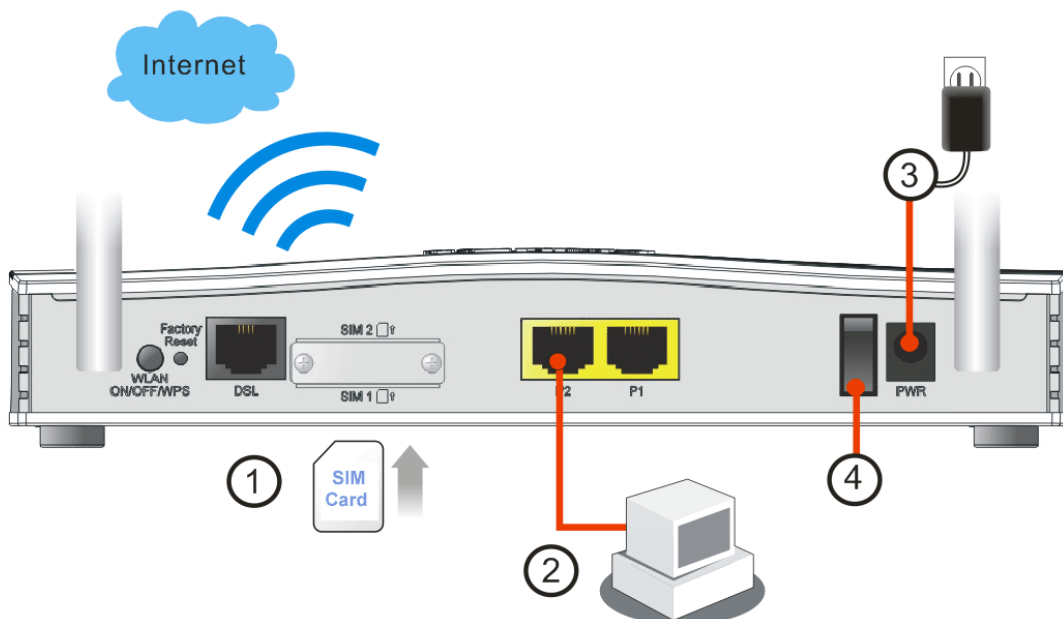

4.2 Network Connection via DSL

1. Connect the DSL interface to the external ADSL splitter with an ADSL line cable.
2. Connect to your computer with a RJ-45 cable.
3. Connect one end of the power cord to the power port of this device. Connect the other end to the wall outlet of electricity.
4. Power on the router.
5. Check the **power** and **DSL**, **LAN** LEDs to assure network connections.

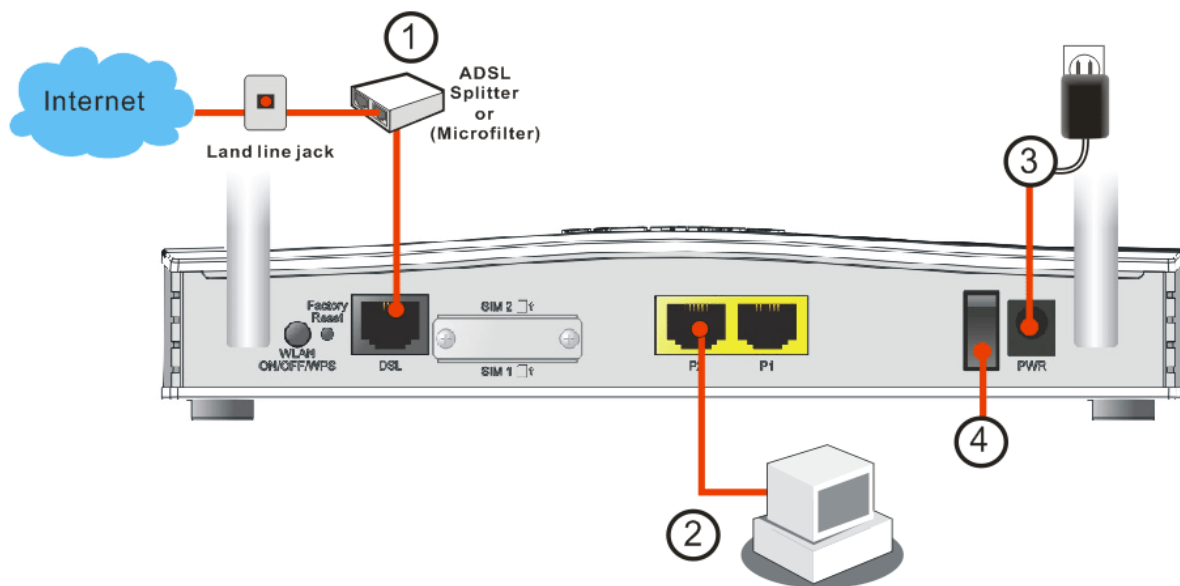

4.2 Wall-Mounted Installation

Vigor router has keyhole type mounting slots on the underside.

1. A template is provided on the Vigor router packaging box to enable you to space the screws correctly on the wall.
2. Place the template on the wall and drill the holes according to the recommended instruction.
3. Fit screws into the wall using the appropriate type of wall plug.

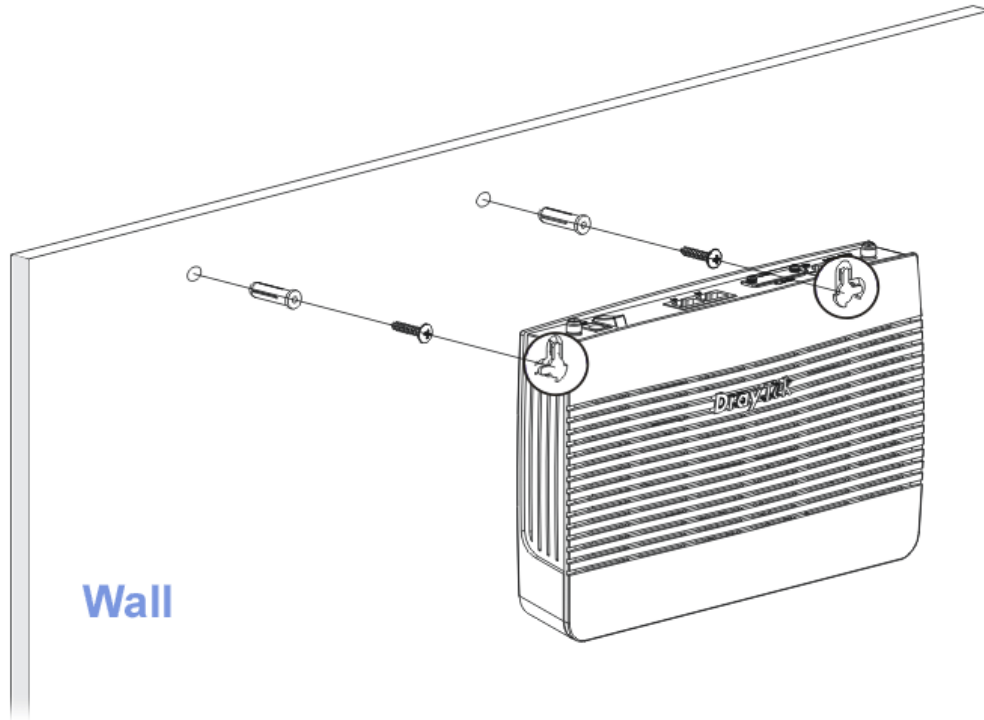

Note

The recommended drill diameter shall be 6.5mm (1/4").

4. When you finished about procedure, the router has been mounted on the wall firmly.

5. Software Configuration

To access Internet, please finish basic configuration after completing the hardware installation.

5.1 Quick Start Wizard for Network Connection

The **Quick Start Wizard** is designed for you to easily set up your router for Internet access. You can directly access the **Quick Start Wizard** via Web User Interface. Make sure your PC connects to the router correctly.



Note

You may either simply set up your computer to get IP dynamically from the router or set up the IP address of the computer to be the same subnet as the **default IP address of Vigor router 192.168.1.1**. For the detailed information, please refer to - Trouble Shooting of the user's guide.

Open a web browser on your PC and type **http://192.168.1.1**. A pop-up window will open to ask for username and password. Please type "admin/admin" as the Username/Password and click **Login**.

DrayTek **Vigor2620 Series**

Login

Username

Password

Login

Security Warning: You are logging in without encryption which is not recommended. To login securely [click here](#).

Copyright © 2000- 2018 DrayTek Corp. All Rights Reserved.



Note

If you fail to access to the web configuration, please go to "Trouble Shooting" on User's Guide for detecting and solving your problem.

Now, the Main Screen will pop up. Click **Wizards>>Quick Start Wizard**.

DrayTek Vigor2620 Series

Dashboard

System Information

Model Name	Vigor2620L	System Up Time	0:0:16
Router Name	DrayTek	Current Time	2000 Jan 1 Sat 0:0:9
Firmware Version	3.8.11	Build Date/Time	Jan 4 2019 14:47:58
DSL Version	S48006_A/B/C HW: A	LAN MAC Address	00-1D-AA-93-9F-3C

IPv4 LAN Information

LAN	IP Address	DHCP	LAN2	IP Address	DHCP
LAN1	192.168.1.1/24	v	LAN2	192.168.2.1/24	v
IP Routed Subnet	192.168.0.1/24	v			

IPv4 Internet Access

Line / Mode	IP Address	MAC Address	Up Time
WAN1 ADSL / PPPoE	Disconnected	00-1D-AA-93-9F-3D	00:00:00
WAN2 Ethernet / ---	Disconnected	00-1D-AA-93-9F-3E	00:00:00
LTE USB / ---	Disconnected	00-1D-AA-93-9F-3F	00:00:00

IPv6 Internet Access

Mode	Address	Scope	Up Time
LAN RADVD / DHCPv6	FE80::21D:AFF:FE93:9F3C/64	Link	

Interface

DSL	Connected : Down Stream : 0Kbps / Up Stream : 0Kbps
WAN	Connected : 0, WAN1, WAN2, LTE
LAN	Connected : 0, Port1, Port2

Security

VPN	Connected : 0	Remote Dial-in User / LAN to LAN
-----	---------------	----------------------------------



Note

The home page will change slightly in accordance with the router you have.

1. If your router can be under an environment with high speed NAT, the configuration provide here can help you to deploy and use the router quickly. The first screen of **Quick Start Wizard** is entering login password. After typing the password, please click **Next**.

Quick Start Wizard

Enter login password

Please enter an alpha-numeric string as your **Password**.

Old Password

New Password

Confirm Password

Hint: If you want to keep the password unchanged, leave the password blank and press "Next" button to skip this process.

2. On the next page, please select the WAN interface that you use. If DSL interface is used, please choose WAN1; if USB interface is used, please

choose LTE. Then click **Next** for next step. WAN1 and LTE will bring up different configuration page. Here, we take LTE as an example.

Quick Start Wizard

WAN Interface

WAN Interface:	LTE ▾
Display Name:	<input type="text"/>
Physical Mode:	USB

3. Click **Next** to go to the following page.

Quick Start Wizard

Connect to Internet

LTE	
Internet Access :	3G/4G LTE Modem(DHCP mode) ▾
3G/4G LTE Modem(DHCP mode)	
SIM PIN code	<input type="text"/>
Network Mode	4G/3G ▾ (Default:4G/3G)
APN Name	<input type="text"/>

4. Manually enter SIM PIN code and SPM Name provided by your ISP. Then click **Next** for viewing summary of such connection.

Quick Start Wizard

Please confirm your settings:

WAN Interface:	LTE
Physical Mode:	USB
Internet Access:	DHCP

Click **Back** to modify changes if necessary. Otherwise, click **Finish** to save the current settings and restart the Vigor router.

5. Click **Finish**. A page of **Quick Start Wizard Setup OK!!!** will appear. Then, the system status of this protocol will be shown.
6. Now, you can enjoy surfing on the Internet.

6. Customer Service

If the router cannot work correctly after trying many efforts, please contact your dealer for further help right away. For any questions, please feel free to send e-mail to support@draytek.com.

Be a Registered Owner

Web registration is preferred. You can register your Vigor router via <http://www.draytek.com>.

Firmware & Tools Updates

Due to the continuous evolution of DrayTek technology, all routers will be regularly upgraded. Please consult the DrayTek web site for more information on newest firmware, tools and documents. <http://www.draytek.com>